

# **Oracle® Database**

Platform Guide

10g Release 1 (10.1) for Windows

**Part No. B10113-01**

December 2003

**ORACLE®**

Oracle Database Platform Guide, 10g Release 1 (10.1) for Windows

Part No. B10113-01

Copyright © 1996, 2003 Oracle Corporation. All rights reserved.

Primary Author: Craig B. Foch

Contributing Author: Mark Kennedy and Helen Slattery

Contributor: David Collelo

The Programs (which include both the software and documentation) contain proprietary information of Oracle Corporation; they are provided under a license agreement containing restrictions on use and disclosure and are also protected by copyright, patent and other intellectual and industrial property laws. Reverse engineering, disassembly or decompilation of the Programs, except to the extent required to obtain interoperability with other independently created software or as specified by law, is prohibited.

The information contained in this document is subject to change without notice. If you find any problems in the documentation, please report them to us in writing. This document is not warranted to be error-free. Except as may be expressly permitted in your license agreement for these Programs, no part of these Programs may be reproduced or transmitted in any form or by any means, electronic or mechanical, for any purpose.

If the Programs are delivered to the U.S. Government or anyone licensing or using the programs on behalf of the U.S. Government, the following notice is applicable:

**Restricted Rights Notice** Programs delivered subject to the DOD FAR Supplement are "commercial computer software" and use, duplication, and disclosure of the Programs, including documentation, shall be subject to the licensing restrictions set forth in the applicable Oracle license agreement. Otherwise, Programs delivered subject to the Federal Acquisition Regulations are "restricted computer software" and use, duplication, and disclosure of the Programs shall be subject to the restrictions in FAR 52.227-19, Commercial Computer Software - Restricted Rights (June, 1987). Oracle Corporation, 500 Oracle Parkway, Redwood City, CA 94065.

The Programs are not intended for use in any nuclear, aviation, mass transit, medical, or other inherently dangerous applications. It shall be the licensee's responsibility to take all appropriate fail-safe, backup, redundancy and other measures to ensure the safe use of such applications if the Programs are used for such purposes, and we disclaim liability for any damages caused by such use of the Programs.

Oracle is a registered trademark, and Oracle Open Gateways, Oracle Store, Oracle7, Oracle8, Oracle8i, Oracle9i, Oracle*MetaLink*, PL/SQL, Pro\*C/C++, Pro\*COBOL, and SQL\*Plus are trademarks or registered trademarks of Oracle Corporation. Other names may be trademarks of their respective owners.

---

---

# Contents

<b>Send Us Your Comments .....</b>	<b>xv</b>
<b>Preface.....</b>	<b>xvii</b>
Audience .....	xviii
Organization.....	xviii
Related Documentation .....	xx
Conventions.....	xxi
Documentation Accessibility .....	xxvi
<b>What's New in Oracle Database for Windows .....</b>	<b>xxix</b>
Oracle Database 10g New Features.....	xxx
Oracle9i Release 2 (9.2.0.2) New Feature.....	xxxii
Oracle9i Release 2 (9.2) New Features .....	xxxii
Oracle9i Release 1 (9.0.1) New Features .....	xxxii
<b>1 Oracle Database Architecture on Windows</b>	
<b>Oracle Database on Windows Architecture.....</b>	<b>1-2</b>
Thread-Based Architecture .....	1-2
File I/O Enhancements.....	1-5
Raw File Support .....	1-5
<b>Oracle Database Scalability on Windows.....</b>	<b>1-5</b>
Support for Very Large Memory (VLM) Configurations .....	1-6
4 GB RAM Tuning (4GT).....	1-9
Large User Populations .....	1-9

<b>Oracle Database Integration with Windows .....</b>	<b>1-10</b>
Oracle PKI Integration with Windows .....	1-11
Oracle Services for Microsoft Transaction Server .....	1-11
Oracle Fail Safe Integration with Windows.....	1-11
Oracle Real Application Clusters Integration with Windows .....	1-12
<b>Other Sources of Information.....</b>	<b>1-12</b>

## **2 Multiple Oracle Homes and Optimal Flexible Architecture**

<b>Introduction to Multiple Oracle Homes and OFA .....</b>	<b>2-2</b>
<b>Multiple Oracle Homes Overview .....</b>	<b>2-2</b>
What Is an Oracle Home? .....	2-2
Benefit of Using Multiple Oracle Homes .....	2-3
One-Listener Support of Multiple Oracle Homes.....	2-3
<b>Changing the Value of PATH.....</b>	<b>2-3</b>
Changing the Value of PATH Using Oracle Universal Installer .....	2-4
Changing the Value of PATH at the System Level.....	2-5
Changing the Value of PATH at the Command Prompt.....	2-5
<b>Exiting Oracle Universal Installer After Entering Name and PATH .....</b>	<b>2-5</b>
<b>Setting Variables in the Environment or the Registry .....</b>	<b>2-6</b>
Setting ORACLE_HOME.....	2-6
Consequences of Setting ORACLE_HOME .....	2-7
Setting TNS_ADMIN .....	2-7
<b>Optimal Flexible Architecture Overview .....</b>	<b>2-8</b>
Benefits of an OFA-Compliant Database .....	2-8
Characteristics of an OFA-Compliant Database .....	2-9
<b>Differences Between Directory Trees by Release .....</b>	<b>2-10</b>
Top-Level Oracle Directory .....	2-10
Database Filenames .....	2-10
Database Filename Extensions.....	2-10
<b>OFA Directory Naming Conventions .....</b>	<b>2-11</b>
ORACLE_BASE Directory .....	2-11
ORACLE_HOME Directory .....	2-12
ADMIN Directory.....	2-12
ORADATA Directory.....	2-12
DB_NAME Directory .....	2-13

<b>OFA and Multiple Oracle Home Configurations</b> .....	2-13
Specifying an ORACLE_HOME Directory .....	2-13
Installing a Default OFA Database: Example .....	2-14
Installing a Nondefault OFA Database: Example 1 .....	2-14
Installing a Nondefault OFA Database: Example 2 .....	2-16
<b>Increasing Reliability and Performance</b> .....	2-17
Disk Mirroring .....	2-17
Disk Striping.....	2-18
Using Raw Partitions for Tablespaces .....	2-18
<b>Comparison Between OFA on Windows and UNIX</b> .....	2-18
Directory Naming.....	2-19
ORACLE_BASE Directory .....	2-19
Support for Symbolic Links on Windows.....	2-19

### 3 Database Tools on Windows

<b>Choosing a Database Tool</b> .....	3-2
Database Tools and Operating System Compatibility .....	3-2
Preferred Database Tools .....	3-3
<b>Starting Database Tools</b> .....	3-5
Starting Database Tools in Multiple Oracle Homes .....	3-6
Starting Tools from Oracle8 Release 8.0.4 and Later 8.0.x Multiple Oracle Homes ....	3-6
Starting Tools from Oracle8i Release 8.1.3 and Later Multiple Oracle Homes .....	3-6
Starting Database Tools from the Start Menu .....	3-6
Starting Database Tools from the Command Line .....	3-8
Starting Windows Tools .....	3-11
<b>Using SQL*Loader</b> .....	3-12
Windows Processing Options.....	3-12
Default (No Processing Option) or "str terminator_string" .....	3-12
"FIX <i>n</i> " .....	3-13
"VAR <i>n</i> " .....	3-13
Case Study Files .....	3-13
Specifying the Bad File.....	3-14
Control File Conventions.....	3-14
<b>Using Windows Tools</b> .....	3-15
Using Event Viewer to Monitor a Database .....	3-15

Using Microsoft Management Console to Administer a Database .....	3-15
Using Oracle Counters for Windows Performance Monitor.....	3-16
Using Registry Editor to Modify Configuration Information.....	3-17
Using Task Manager to Monitor Applications and Processes .....	3-17
Using Local Users and Groups to Manage Users and Groups .....	3-18
Using User Manager to Manage Users.....	3-18
<b>Optional Windows Diagnostic and Tuning Utilities .....</b>	<b>3-18</b>

## **4 Postinstallation Database Creation on Windows**

<b>Naming Conventions for Oracle Database .....</b>	<b>4-2</b>
<b>Accessing Data Files and Log Files on Remote Computers.....</b>	<b>4-2</b>
<b>Creating a Database on Windows Using Database Configuration Assistant .....</b>	<b>4-3</b>
<b>Creating a Database on Windows Using Command-Line Tools .....</b>	<b>4-4</b>
Creating Directories.....	4-5
Exporting an Existing Database.....	4-6
Deleting Database Files.....	4-8
Modifying the Initialization Parameter File.....	4-8
Starting an Oracle Database Instance .....	4-10
Creating and Starting an Oracle Database Service .....	4-10
Putting the CREATE DATABASE Statement in a Script .....	4-11
Running the CREATE DATABASE Script .....	4-12
Importing a Database .....	4-13
Updating ORACLE_SID in the Registry .....	4-14
Backing Up the New Database .....	4-16
<b>Using ORADIM to Administer an Oracle Database Instance .....</b>	<b>4-18</b>
Creating an Instance .....	4-19
Starting an Instance and Services .....	4-20
Stopping an Instance and Services .....	4-21
Editing an Instance .....	4-22
Deleting an Instance .....	4-23

## **5 Postinstallation Configuration Tasks on Windows**

<b>Resetting Passwords for Default Accounts.....</b>	<b>5-2</b>
<b>NTFS File System and Windows Registry Permissions .....</b>	<b>5-2</b>
File Permissions .....	5-2

File Permissions Set by Oracle Universal Installer .....	5-3
File Permissions Set by Database Configuration Assistant.....	5-3
File Permissions Set by Database Upgrade Assistant .....	5-4
Setting NTFS File System Security .....	5-4
Setting Windows Registry Security .....	5-5
<b>Configuring External Job Support for the Scheduler on Windows.....</b>	<b>5-6</b>
<b>Oracle <i>interMedia</i> on Windows .....</b>	<b>5-6</b>
Upgrading Oracle <i>interMedia</i> from an Earlier Release.....	5-7
Configuring Oracle <i>interMedia</i> Audio, Video, Image, and Locator .....	5-8
Configuring Oracle <i>interMedia</i> Demos .....	5-9
<b>Configuring Oracle Text on Windows.....</b>	<b>5-10</b>
<b>Configuring Oracle Spatial on Windows.....</b>	<b>5-13</b>
<b>Configuring Advanced Replication on Windows .....</b>	<b>5-14</b>
Checking Tablespace and Rollback Segment Requirements.....	5-14
Adding and Modifying Initialization Parameters .....	5-15
Monitoring Data Dictionary Tables .....	5-16

## 6 Administering a Database on Windows

<b>Managing Oracle Database Services.....</b>	<b>6-2</b>
Oracle Database Service Naming Conventions for Multiple Oracle Homes.....	6-2
Starting Oracle Database Services.....	6-2
Stopping Oracle Database Services.....	6-4
Auto-starting Oracle Database Services .....	6-5
<b>Starting and Shutting Down a Database with SQL*Plus .....</b>	<b>6-8</b>
<b>Starting and Shutting Down a Database Using Services.....</b>	<b>6-9</b>
<b>Starting Multiple Instances .....</b>	<b>6-13</b>
<b>Creating and Populating Password Files .....</b>	<b>6-14</b>
Viewing and Hiding the Password File .....	6-16
<b>Connecting Remotely to the Database as SYS .....</b>	<b>6-17</b>
<b>Automatically Encrypted Database Passwords .....</b>	<b>6-18</b>
<b>Creating Control, Data, and Log Files on Remote Computers.....</b>	<b>6-18</b>
<b>Archiving Redo Log Files.....</b>	<b>6-19</b>
Changing Archive Mode to ARCHIVELOG .....	6-19
Enabling Automatic Archiving .....	6-20

## 7 Monitoring a Database on Windows

<b>Database Monitoring Overview</b> .....	7-2
<b>Using Oracle Counters for Windows Performance Monitor</b> .....	7-2
Registry Information .....	7-3
Accessing Oracle Counters for Windows Performance Monitor .....	7-4
Modifying Views .....	7-4
Understanding Oracle Database Performance Objects .....	7-5
Oracle Counters for Windows Performance Monitor Troubleshooting Information .....	7-8
<b>Using Event Viewer</b> .....	7-8
Reading Event Viewer .....	7-10
Managing Event Viewer .....	7-12
<b>Trace Files</b> .....	7-12
<b>Alert Files</b> .....	7-13
<b>Viewing Threads</b> .....	7-13

## 8 Tuning Windows to Optimize Oracle Database

<b>Windows Tuning Overview</b> .....	8-2
<b>Large Page Support</b> .....	8-2
<b>User Threads</b> .....	8-3
When to Use User-Thread Mode.....	8-3
Enabling User-Thread Mode.....	8-5
Disabling User-Thread Mode.....	8-5
<b>Reduce Priority of Foreground Applications on Server Console</b> .....	8-5
<b>Configure Windows Server to Be an Application Server</b> .....	8-6
<b>Disable Unnecessary Services</b> .....	8-6
<b>Remove Unused Network Protocols</b> .....	8-7
<b>Reset Network Protocol Bind Order</b> .....	8-8
<b>Apply Latest Reliable Windows Server Service Pack</b> .....	8-8
<b>Use Hardware or Operating System Striping</b> .....	8-8
Multiple Striped Volumes for Sequential and Random Access.....	8-10
<b>Multiplex Windows Server Virtual Memory Paging File</b> .....	8-11
<b>Close All Unnecessary Foreground Applications</b> .....	8-11



## 9 Authenticating Database Users with Windows

Windows Native Authentication Overview .....	9-2
Windows Authentication Protocols .....	9-2
User Authentication and Role Authorization Methods .....	9-3
Authentication and Authorization Methods To Use.....	9-4
Operating System Authentication Enabled at Installation .....	9-5

## 10 Administering External Users and Roles on Windows

Oracle Administration Assistant for Windows .....	10-2
Managing a Remote Computer .....	10-3
Adding a Computer and Saving Your Configuration .....	10-4
Granting Administrator Privileges for All Databases on a Computer .....	10-5
Granting Operator Privileges for All Databases on a Computer .....	10-7
Connecting to a Database .....	10-9
Troubleshooting Connection Problems .....	10-11
Viewing Database Authentication Parameter Settings .....	10-14
Creating an External Operating System User .....	10-15
Creating a Local Database Role .....	10-23
Creating an External Operating System Role .....	10-29
Granting Administrator Privileges for a Single Database .....	10-34
Granting Operator Privileges for a Single Database .....	10-36
Manually Administering External Users and Roles .....	10-38
Manually Creating an External Operating System User .....	10-39
External User Authentication Tasks on the Oracle Database Server .....	10-39
External User Authentication Tasks on the Client Computer .....	10-43
Manually Granting Administrator and Operator Privileges for Databases .....	10-44
SYSDBA/SYSOPER Authentication Tasks on the Oracle Database Server .....	10-45
SYSDBA/SYSOPER Authentication Tasks on the Client Computer .....	10-46
Manually Creating an External Role.....	10-46
External Role Authorization Tasks on the Oracle Database Server .....	10-47
External Role Authorization Tasks on the Client Computer .....	10-49
Manually Migrating Users .....	10-50

<b>11</b>	<b>Storing Oracle Wallets in the Windows Registry</b>	
	Storing Private Keys and Trust Points .....	11-2
	Storing User's Profile .....	11-2
	Registry Parameters for Wallet Storage .....	11-2
	Oracle Wallet Manager .....	11-3
<b>12</b>	<b>Oracle PKI Integration with Windows</b>	
	Oracle Public Key Infrastructure .....	12-2
	Windows Public Key Infrastructure .....	12-2
	Microsoft Certificate Stores .....	12-2
	Microsoft Certificate Services.....	12-3
	Using Microsoft Certificate Stores with Oracle PKI Applications.....	12-3
<b>13</b>	<b>Oracle Database Specifications for Windows</b>	
	Initialization Parameter File Overview .....	13-2
	Location of the Initialization Parameter File.....	13-2
	Editing The Initialization Parameter File .....	13-3
	Database Configuration Assistant Renames init.ora .....	13-3
	Sample File .....	13-3
	SGA_MAX_SIZE Parameter .....	13-4
	Initialization Parameters Without Windows-Specific Values.....	13-5
	Displaying Initialization Parameter Values .....	13-6
	Uneditable Database Initialization Parameters .....	13-6
	Calculating Database Limits.....	13-7
<b>14</b>	<b>Configuration Parameters and the Registry</b>	
	About Configuration Parameters.....	14-2
	Registry Overview .....	14-2
	Registry Parameters .....	14-3
	HKEY_LOCAL_MACHINE\SOFTWARE\ORACLE\KEY_HOME_NAME .....	14-3
	MSHELP_TOOLS .....	14-3
	NLS_LANG .....	14-4
	ORA_CWD .....	14-4
	ORA_SID_AUTOSTART .....	14-4

ORA_SID_PFILE.....	14-4
ORA_SID_SHUTDOWN.....	14-4
ORA_SID_SHUTDOWN_TIMEOUT.....	14-4
ORA_SID_SHUTDOWNTYPE.....	14-4
ORA_TZFILE.....	14-5
ORACLE_AFFINITY.....	14-5
ORACLE_BASE.....	14-6
ORACLE_GROUP_NAME.....	14-6
ORACLE_HOME.....	14-6
ORACLE_HOME_KEY.....	14-6
ORACLE_HOME_NAME.....	14-6
ORACLE_PRIORITY.....	14-6
ORACLE_SID.....	14-7
OSAUTH_PREFIX_DOMAIN.....	14-7
OSAUTH_X509_NAME.....	14-7
RDBMS_ARCHIVE.....	14-7
RDBMS_CONTROL.....	14-7
SQLPATH.....	14-8
HKEY_LOCAL_MACHINE\SOFTWARE\ORACLE.....	14-8
INST_LOC.....	14-8
OO4O.....	14-8
HKEY_LOCAL_MACHINE\SYSTEM\CurrentControlSet\Services.....	14-8
Parameters for Oracle Counters for Windows Performance Monitor.....	14-8
Parameters for Oracle Database Services.....	14-10
<b>Oracle Real Application Clusters Registry Parameters.....</b>	<b>14-10</b>
HKEY_LOCAL_MACHINE\SOFTWARE\ORACLE\OCR.....	14-11
<b>Modifying a Registry Value with regedt32.....</b>	<b>14-11</b>
<b>Adding a Registry Parameter with regedt32.....</b>	<b>14-12</b>
<b>Adding or Modifying Registry Parameters with Oracle Administration Assistant for Windows.....</b>	<b>14-14</b>
Starting Oracle Administration Assistant for Windows.....	14-14
Adding Oracle Home Parameters.....	14-17
Editing Oracle Home Parameters.....	14-17
Deleting Oracle Home Parameters.....	14-19
<b>Modifying Oracle Counters for Windows Performance Monitor Parameters.....</b>	<b>14-19</b>
Using OPERFCFGver.....	14-20

Using Oracle Administration Assistant for Windows .....	14-21
---	-------

## 15 Developing Applications for Windows

<b>Finding Information on Application Development for Windows .....</b>	<b>15-2</b>
Java Enhancements.....	15-2
XML Support .....	15-2
Support for Internet Applications .....	15-2
Application Wizards .....	15-2
Oracle COM/COM+ Integration Feature .....	15-3
Oracle Services For Microsoft Transaction Server .....	15-3
Pro*C/C++ and Pro*COBOL Applications .....	15-3
OLE DB.....	15-3
<b>Developing Windows Applications .....</b>	<b>15-3</b>
Developing Internet Applications.....	15-5
<b>Building External Procedures .....</b>	<b>15-7</b>
External Procedures Overview .....	15-8
Installing and Configuring .....	15-9
Installing Oracle Database.....	15-9
Configuring Oracle Net Services.....	15-9
Writing an External Procedure .....	15-10
Building a DLL .....	15-11
Registering an External Procedure.....	15-11
Executing an External Procedure .....	15-13
<b>Debugging External Procedures .....</b>	<b>15-14</b>
Using Package DEBUG_EXTPROC .....	15-14
<b>Accessing Text Files with UTL_FILE.....</b>	<b>15-15</b>
<b>Accessing Web Data with Intercartridge Exchange.....</b>	<b>15-15</b>
Configuring Intercartridge Exchange.....	15-16
Using Intercartridge Exchange .....	15-17
Packaged Function UTL_HTTP.REQUEST .....	15-19
Packaged Function UTL_HTTP.REQUEST_PIECES.....	15-19
UTL_HTTP Exception Conditions .....	15-20
UTL_HTTP.REQUEST .....	15-20
UTL_HTTP.REQUEST_PIECES .....	15-21
Exception Conditions and Error Messages .....	15-21

## **A Getting Started with Your Documentation**

## **B Storing Tablespaces on Raw Partitions**

<b>Raw Partition Overview</b> .....	B-2
Physical Disk .....	B-2
Logical Partition.....	B-3
Physical Disk and Logical Partition Considerations .....	B-3
Compatibility Issues.....	B-4
<b>Creating a Tablespace in a Raw Partition</b> .....	B-5

## **C Oracle Net Services Configuration on Windows**

<b>Understanding Oracle Net Services Registry Parameters and Subkeys</b> .....	C-2
Oracle Net Service Subkeys .....	C-2
<b>Listener Requirements</b> .....	C-2
<b>Understanding Optional Configuration Parameters</b> .....	C-3
LOCAL .....	C-3
TNS_ADMIN.....	C-3
USE_SHARED_SOCKET .....	C-4
<b>Advanced Network Configuration</b> .....	C-4
Configuring Authentication Method.....	C-4
Configuring Security for Named Pipes Protocol .....	C-4
Modifying Configuration of External Procedures for Higher Security .....	C-4

## **D Error Messages on Windows**

<b>ORA-09275: CONNECT INTERNAL No Longer Supported</b> .....	D-2
<b>OSD-04000 to OSD-04599: Windows-Specific Oracle Database Messages</b> .....	D-2
File I/O Errors: OSD-04000 to OSD-04099 .....	D-5
Memory Errors: OSD-04100 to OSD-04199 .....	D-10
Process Errors: OSD-04200 to OSD-04299 .....	D-11
Loader Errors: OSD-04300 to OSD-04399.....	D-14
Semaphore Errors: OSD-04400 to OSD-04499 .....	D-15
Miscellaneous Errors: OSD-04500 to OSD-04599 .....	D-15
<b>DIM-00000 to DIM-00039: ORADIM Command Syntax Errors</b> .....	D-17
<b>Database Connection Issues</b> .....	D-26

## **E Using Oracle Database on Windows 2000**

<b>How to Perform Common Tasks in Windows NT and Windows 2000</b> .....	E-2
<b>Other Differences Between Windows NT and Windows 2000</b> .....	E-3
No DNS Domain Name for Windows 2000 Computer.....	E-3
Microsoft Management Console Included in Windows 2000 .....	E-4
Raw Partitions .....	E-4
Services Autostart.....	E-4

## **F Oracle Database Windows/UNIX Differences**

<b>Automatic Startup and Shutdown</b> .....	F-2
<b>Background Processing and Batch Jobs</b> .....	F-2
<b>Diagnostic and Tuning Utilities</b> .....	F-2
<b>Direct Writes to Disk</b> .....	F-3
<b>Dynamic Link Libraries (DLLs)</b> .....	F-3
<b>Hot Backups</b> .....	F-4
<b>Initialization Parameters: Multiple Database Writers</b> .....	F-4
<b>Install Accounts and Groups</b> .....	F-4
<b>Installation</b> .....	F-5
<b>Memory Resources</b> .....	F-5
<b>Microsoft Transaction Server</b> .....	F-5
<b>Multiple Oracle Homes and OFA</b> .....	F-6
<b>Processes and Threads</b> .....	F-6
<b>Raw Partitions</b> .....	F-7
<b>Services</b> .....	F-8

## **Glossary**

## **Index**

---

---

# Send Us Your Comments

## **Oracle Database Platform Guide, 10g Release 1 (10.1) for Windows**

**Part No. B10113-01**

Oracle welcomes your comments and suggestions on the quality and usefulness of this publication. Your input is an important part of the information used for revision.

- Did you find any errors?
- Is the information clearly presented?
- Do you need more information? If so, where?
- Are the examples correct? Do you need more examples?
- What features did you like most about this manual?

If you find any errors or have any other suggestions for improvement, please indicate the title and part number of the documentation and the chapter, section, and page number (if available). You can send comments to us in the following ways:

- Electronic mail: [ntdoc\\_us@oracle.com](mailto:ntdoc_us@oracle.com)
- FAX: (650) 506-7365 Attn: Oracle Database for Windows Documentation
- Postal service:  
Oracle  
Oracle Database for Windows Documentation Manager  
500 Oracle Parkway, Mailstop 10p6  
Redwood Shores, CA 94065  
USA

If you would like a reply, please give your name, address, telephone number, and electronic mail address (optional).

If you have problems with the software, please contact your local Oracle Support Services.





---

---

# Preface

This guide is your primary source of introductory and reference information for Oracle Database for Windows for both client and server. Differences between product versions are noted where appropriate.

This document describes the features of Oracle Database for Windows software that apply to the Windows NT Server, Windows 2000, Windows XP, and Windows Server 2003 operating systems.

This preface contains these topics:

- [Audience](#)
- [Organization](#)
- [Related Documentation](#)
- [Conventions](#)
- [Documentation Accessibility](#)

## Audience

*Oracle Database Platform Guide* is intended for:

- Database administrators
- Network administrators
- Security specialists
- Developers who use Oracle Database

To use this document, you need:

- Oracle-certified Windows operating system software installed and tested
- Knowledge of object-relational database management concepts

## Organization

This document contains:

### **What's New in Oracle Database for Windows**

#### **Chapter 1, "Oracle Database Architecture on Windows"**

This chapter describes how Oracle Database architecture takes advantage of some of the more advanced services in the Windows operating system.

#### **Chapter 2, "Multiple Oracle Homes and Optimal Flexible Architecture"**

This chapter describes how to use multiple Oracle homes and an Optimal Flexible Architecture (OFA) configuration for placement of database files.

#### **Chapter 3, "Database Tools on Windows"**

This chapter provides a list of preferred and optional tools you can use to perform common database administration tasks. It also explains how to start these tools.

#### **Chapter 4, "Postinstallation Database Creation on Windows"**

This chapter explains how to create a database after installing Oracle Database, using either the Database Configuration Assistant or command-line tools.

#### **Chapter 5, "Postinstallation Configuration Tasks on Windows"**

This chapter describes some of the configuration tasks you must perform before using Oracle *interMedia* and other Oracle options.

## **Chapter 6, "Administering a Database on Windows"**

This chapter explains how to administer Oracle Database for Windows.

## **Chapter 7, "Monitoring a Database on Windows"**

This chapter explains how to monitor Oracle Database for Windows.

## **Chapter 8, "Tuning Windows to Optimize Oracle Database"**

This chapter explains how to tune Windows Server operating systems to ensure that Oracle Database is running in the best possible environment.

## **Chapter 9, "Authenticating Database Users with Windows"**

This chapter describes authentication of Oracle Database users on Windows operating systems.

## **Chapter 10, "Administering External Users and Roles on Windows"**

This chapter describes the administration of external users and roles.

## **Chapter 11, "Storing Oracle Wallets in the Windows Registry"**

This chapter describes the storing and retrieving of Oracle Wallets in the Windows registry.

## **Chapter 12, "Oracle PKI Integration with Windows"**

This chapter describes the integration of Oracle public key infrastructure (PKI) with Windows 2000 public key infrastructure (Windows PKI) on Windows operating systems.

## **Chapter 13, "Oracle Database Specifications for Windows"**

This chapter discusses initialization parameters, which Oracle Database uses on Windows to enable various features of the database every time an instance is started.

## **Chapter 14, "Configuration Parameters and the Registry"**

This chapter describes the use of the registry for various Oracle Database components. In addition, this chapter lists the recommended values and ranges for configuration parameters.

## **Chapter 15, "Developing Applications for Windows"**

This chapter points to sources of information on developing applications for Windows and outlines a procedure for building and debugging external procedures.

## **Appendix A, "Getting Started with Your Documentation"**

This appendix describes the contents of your Oracle Database documentation set.

## **Appendix B, "Storing Tablespaces on Raw Partitions"**

This appendix describes how to configure your system to store datafiles for tablespaces on raw partitions.

## **Appendix C, "Oracle Net Services Configuration on Windows"**

This appendix describes Oracle Net Services configuration for Windows. For an overview of Oracle Net Services configuration in general, see *Oracle Net Services Administrator's Guide*.

## **Appendix D, "Error Messages on Windows"**

This appendix lists error messages, causes, and corrective actions that are specific to the operation of Oracle Database for Windows.

## **Appendix E, "Using Oracle Database on Windows 2000"**

This appendix highlights differences between Windows 2000 and Windows NT, with emphasis on procedures for common database tasks.

## **Appendix F, "Oracle Database Windows/UNIX Differences"**

This appendix compares features of Oracle Database for Windows and UNIX. This information may be helpful to Oracle Database developers and database administrators moving from UNIX to Windows platforms.

## **Glossary**

## **Related Documentation**

For information on the components available in your Oracle Database installation type, see your *Oracle Database Installation Guide for Windows*.

For Oracle Database product information that is applicable to *all* operating systems, see your Oracle Database Online Documentation Library CD-ROM for Windows.

Many of the examples in the documentation set use the sample schemas of the seed database, which is installed by default when you install Oracle Database. Refer to *Oracle Database Sample Schemas* for information on how these schemas were created and how you can use them yourself.

For information about Oracle Database error messages, see *Oracle Database Error Messages*. Oracle Database error message documentation is available only in HTML. If you only have access to the Oracle Database Documentation CD, you can browse the error messages by range. Once you find the specific range, use your browser's "find in page" feature to locate the specific message. When connected to the Internet, you can search for a specific error message using the error message search feature of the Oracle Database online documentation.

If you are not familiar with object-relational database management concepts, see *Oracle Database Concepts*.

Printed documentation is available for sale in the Oracle Store at <http://oraclestore.oracle.com/>

To download free release notes, installation documentation, white papers, or other collateral, please visit the Oracle Technology Network (OTN). You must register online before using OTN; registration is free and can be done at <http://otn.oracle.com/membership/>

If you already have a username and password for OTN, then you can go directly to the documentation section of the OTN Web site at <http://otn.oracle.com/documentation/>

## Conventions

This section describes the conventions used in the text and code examples of this documentation set. It describes:

- [Conventions in Text](#)
- [Conventions in Code Examples](#)
- [Conventions for Windows Operating Systems](#)

## Conventions in Text

We use various conventions in text to help you more quickly identify special terms. The following table describes those conventions and provides examples of their use.

Convention	Meaning	Example
<b>Bold</b>	Bold typeface indicates terms that are defined in the text or terms that appear in a glossary, or both.	When you specify this clause, you create an <b>index-organized table</b> .
<i>Italics</i>	Italic typeface indicates book titles or emphasis.	<i>Oracle Database Concepts</i> Ensure that the recovery catalog and target database do <i>not</i> reside on the same disk.
UPPERCASE monospace (fixed-width) font	Uppercase monospace typeface indicates elements supplied by the system. Such elements include parameters, privileges, datatypes, RMAN keywords, SQL keywords, SQL*Plus or utility commands, packages and methods, as well as system-supplied column names, database objects and structures, usernames, and roles.	You can specify this clause only for a NUMBER column. You can back up the database by using the BACKUP command. Query the TABLE_NAME column in the USER_TABLES data dictionary view. Use the DBMS_STATS.GENERATE_STATS procedure.
lowercase monospace (fixed-width) font	Lowercase monospace typeface indicates executables, filenames, directory names, and sample user-supplied elements. Such elements include computer and database names, net service names, and connect identifiers, as well as user-supplied database objects and structures, column names, packages and classes, usernames and roles, program units, and parameter values. <b>Note:</b> Some programmatic elements use a mixture of UPPERCASE and lowercase. Enter these elements as shown.	Enter sqlplus to open SQL*Plus. The password is specified in the orapwd file. Back up the datafiles and control files in the /disk1/oracle/dbs directory. The department_id, department_name, and location_id columns are in the hr.departments table. Set the QUERY_REWRITE_ENABLED initialization parameter to true. Connect as oe user. The JRepUtil class implements these methods.
<i>lowercase italic monospace (fixed-width) font</i>	Lowercase italic monospace font represents placeholders or variables.	You can specify the <i>parallel_clause</i> . Run <code>Uold_release.SQL</code> where <i>old_release</i> refers to the release you installed prior to upgrading.

## Conventions in Code Examples

Code examples illustrate SQL, PL/SQL, SQL\*Plus, or other command-line statements. They are displayed in a monospace (fixed-width) font and separated from normal text as shown in this example:

```
SELECT username FROM dba_users WHERE username = 'MIGRATE';
```

The following table describes typographic conventions used in code examples and provides examples of their use.

Convention	Meaning	Example
[ ]	Brackets enclose one or more optional items. Do not enter the brackets.	DECIMAL ( <i>digits</i> [ , <i>precision</i> ])
{ }	Braces enclose two or more items, one of which is required. Do not enter the braces.	{ENABLE   DISABLE}
	A vertical bar represents a choice of two or more options within brackets or braces. Enter one of the options. Do not enter the vertical bar.	{ENABLE   DISABLE} [COMPRESS   NOCOMPRESS]
...	Horizontal ellipsis points indicate either: <ul style="list-style-type: none"> <li>That we have omitted parts of the code that are not directly related to the example</li> <li>That you can repeat a portion of the code</li> </ul>	CREATE TABLE ... AS <i>subquery</i> ;  SELECT <i>col1</i> , <i>col2</i> , ... , <i>coln</i> FROM employees;
.	Vertical ellipsis points indicate that we have omitted several lines of code not directly related to the example.	SQL> SELECT NAME FROM V\$DATAFILE; NAME -----  /fs1/dbs/tbs_01.dbf /fs1/dbs/tbs_02.dbf  . . .  /fs1/dbs/tbs_09.dbf 9 rows selected.
Other notation	You must enter symbols other than brackets, braces, vertical bars, and ellipsis points as shown.	acctbal NUMBER(11,2); acct     CONSTANT NUMBER(4) := 3;

Convention	Meaning	Example
<i>Italics</i>	Italicized text indicates placeholders or variables for which you must supply particular values.	CONNECT SYSTEM/ <i>system_password</i> DB_NAME = <i>database_name</i>
UPPERCASE	Uppercase typeface indicates elements supplied by the system. We show these terms in uppercase in order to distinguish them from terms you define. Unless terms appear in brackets, enter them in the order and with the spelling shown. However, because these terms are not case sensitive, you can enter them in lowercase.	SELECT last_name, employee_id FROM employees; SELECT * FROM USER_TABLES; DROP TABLE hr.employees;
lowercase	Lowercase typeface indicates programmatic elements that you supply. For example, lowercase indicates names of tables, columns, or files.  <b>Note:</b> Some programmatic elements use a mixture of UPPERCASE and lowercase. Enter these elements as shown.	SELECT last_name, employee_id FROM employees; sqlplus hr/hr CREATE USER mjones IDENTIFIED BY ty3MU9;

## Conventions for Windows Operating Systems

The following table describes conventions for Windows operating systems and provides examples of their use.

Convention	Meaning	Example
Choose Start >	How to start a program.	To start the Database Configuration Assistant, choose Start > Programs > Oracle - <i>HOME_NAME</i> > Configuration and Migration Tools > Database Configuration Assistant.
File and directory names	File and directory names are not case sensitive. The following special characters are not allowed: left angle bracket (<), right angle bracket (>), colon (:), double quotation marks ("), slash (/), pipe ( ), and dash (-). The special character backslash (\) is treated as an element separator, even when it appears in quotes. If the file name begins with \\, then Windows assumes it uses the Universal Naming Convention.	c:\winnt\"\"system32 is the same as C:\WINNT\SYSTEM32



Convention	Meaning	Example
C:\>	Represents the Windows command prompt of the current hard disk drive. The escape character in a command prompt is the caret (^). Your prompt reflects the subdirectory in which you are working. Referred to as the <i>command prompt</i> in this manual.	C:\oracle\oradata>
Special characters	The backslash (\) special character is sometimes required as an escape character for the double quotation mark (") special character at the Windows command prompt. Parentheses and the single quotation mark (') do not require an escape character. Refer to your Windows operating system documentation for more information on escape and special characters.	C:\>exp scott/tiger TABLES=emp QUERY=\"WHERE job='SALESMAN' and sal<1600\" C:\>imp SYSTEM/password FROMUSER=scott TABLES=(emp, dept)
HOME_NAME	Represents the Oracle home name. The home name can be up to 16 alphanumeric characters. The only special character allowed in the home name is the underscore.	C:\> net start OracleHOME_NAME\TNSListener

Convention	Meaning	Example
<i>ORACLE_HOME</i> and <i>ORACLE_BASE</i>	<p>In releases prior to Oracle8i release 8.1.3, when you installed Oracle components, all subdirectories were located under a top level <i>ORACLE_HOME</i> directory. For Windows NT, the default location was <code>C:\orant</code>.</p> <p>This release complies with Optimal Flexible Architecture (OFA) guidelines. All subdirectories are not under a top level <i>ORACLE_HOME</i> directory. There is a top level directory called <i>ORACLE_BASE</i> that by default is <code>C:\oracle</code>. If you install the latest Oracle release on a computer with no other Oracle software installed, then the default setting for the first Oracle home directory is <code>C:\oracle\orann</code>, where <i>nn</i> is the latest release number. The Oracle home directory is located directly under <i>ORACLE_BASE</i>.</p> <p>All directory path examples in this guide follow OFA conventions.</p> <p>Refer to <i>Oracle Database Platform Guide for Windows</i> for additional information about OFA compliances and for information about installing Oracle products in non-OFA compliant directories.</p>	Go to the <i>ORACLE_BASE\ORACLE_HOME\rdms\admin</i> directory.

## Documentation Accessibility

Our goal is to make Oracle products, services, and supporting documentation accessible, with good usability, to the disabled community. To that end, our documentation includes features that make information available to users of assistive technology. This documentation is available in HTML format, and contains markup to facilitate access by the disabled community. Standards will continue to evolve over time, and Oracle is actively engaged with other market-leading technology vendors to address technical obstacles so that our documentation can be accessible to all of our customers. For additional information, visit the Oracle Accessibility Program Web site at

<http://www.oracle.com/accessibility/>

**Accessibility of Code Examples in Documentation** JAWS, a Windows screen reader, may not always correctly read the code examples in this document. The conventions for writing code require that closing braces should appear on an otherwise empty line; however, JAWS may not always read a line of text that consists solely of a bracket or brace.

**Accessibility of Links to External Web Sites in Documentation** This documentation may contain links to Web sites of other companies or organizations that Oracle does not own or control. Oracle neither evaluates nor makes any representations regarding the accessibility of these Web sites.



---

---

# What's New in Oracle Database for Windows

This section describes new features of Oracle Database and provides pointers to additional information. New features information from previous releases is also retained to help those users migrating to the current release.

The following sections describe new features:

- [Oracle Database 10g New Features](#)
- [Oracle9i Release 2 \(9.2.0.2\) New Feature](#)
- [Oracle9i Release 2 \(9.2\) New Features](#)
- [Oracle9i Release 1 \(9.0.1\) New Features](#)

## Oracle Database 10g New Features

This section contains these topics:

- [Large Page Support](#)
- [Scheduler](#)
- [Database Password Encryption](#)
- [Data Pump Import and Export](#)
- [Oracle Database for 64-Bit Windows](#)

### Large Page Support

Large page support provides a performance boost for memory-intensive database instances running on Windows Server 2003. By taking advantage of newly introduced operating system support, Oracle Database 10g can now make more efficient use of processor memory addressing resources.

**See Also:** ["Large Page Support"](#) on page 8-2

### Scheduler

This release includes a new database scheduler to provide enterprise scheduling functionality. External jobs performed by the user are started using the OracleJobScheduler service. This service is disabled by default. In order to use the external jobs functionality, the administrator must set the username and password for the user account under which this service must run, and enable the service.

Restricting execution of external jobs to a low-privileged user prevents any random database user from gaining operating system level privileges, but it also places restrictions on the kinds of jobs that can be run. Jobs requiring a higher level of operating system privileges cannot be run by this mechanism.

On Windows, running an external job involves the following processes:

- Job slave process (one for each job)
- ext job service (one service, with one thread for each job)
- The actual external executable or job (one for each external job)

**See Also:**

- "The Scheduler" in *Oracle Database New Features*
- "Overview of Scheduler Concepts" in *Oracle Database Administrator's Guide*
- "Using the Scheduler" in *Oracle Database Administrator's Guide*
- "Managing the Scheduler" in *Oracle Database Administrator's Guide*

**Database Password Encryption**

When a user attempts a remote login to Oracle Database, the password is automatically encrypted before it is sent to the remote database. For more information, see "[Automatically Encrypted Database Passwords](#)" on page 6-18.

**Data Pump Import and Export**

Two new utilities offer faster transfer of files to and from Oracle Database. The older file transfer utilities, Import and Export, are retained for use with databases created with earlier versions of Oracle software. For more information on Data Pump Import and Export, see [Chapter 3, "Database Tools on Windows"](#).

**Oracle Database for 64-Bit Windows**

Oracle plans to release a 64-bit version of Oracle Database 10g for Windows at a later date.

**See Also:** <http://otn.oracle.com> for the latest version of Oracle Database for 64-bit Windows

**Oracle9i Release 2 (9.2.0.2) New Feature**

Beginning with Oracle9i release 2 (9.2.0.2.1) for 64-bit Windows, Oracle supports 64-bit processing in the following operating systems:

- Windows XP 64-bit Edition Version 2003
- Windows Server 2003 for 64-bit Itanium 2 Systems

Most of the features and functions of the 32-bit version carry over to the 64-bit version.

**See Also:** <http://otn.oracle.com> for the latest version of Oracle Database for 64-bit Windows

## Oracle9i Release 2 (9.2) New Features

This section contains these topics:

- [Very Large Memory Support](#)
- [User Migration Utility](#)

### Very Large Memory Support

Oracle9i release 2 (9.2) for Windows supports Very Large Memory (VLM) configurations in Windows 2000 and Windows XP, which allow Oracle9i release 2 (9.2) to access more than the 4 gigabyte (GB) of RAM traditionally available to Windows applications. For more information, see "[Oracle Database Scalability on Windows](#)" on page 1-5.

### User Migration Utility

A new command-line tool, User Migration Utility, simplifies conversion of local or external database users to enterprise users. For more information, see:

- [Database Tools on Windows](#) on page 3-1
- [Manually Migrating Users](#) on page 10-50
- "Using the User Migration Utility" in *Oracle Advanced Security Administrator's Guide*

## Oracle9i Release 1 (9.0.1) New Features

This section contains these topics:

- [Windows XP Support](#)
- [Database Configuration Assistant Improvements](#)
- [Oracle Internet Directory Administration Improvements](#)
- [Using Oracle Database on Windows 2000](#)
- [CONNECT INTERNAL Not Supported](#)
- [Server Manager Not Supported](#)



## Windows XP Support

Oracle9i release 1 (9.0.1.1.1) for Windows is certified on the 32-Bit version of Windows XP Professional Edition.

Oracle provides support information for components on various platforms, lists compatible client and database versions, and identifies patches and workaround information. Find the latest certification information at <http://metalink.oracle.com/>

You must register online before using Oracle*MetaLink*. After logging into Oracle*MetaLink*, select Product Lifecycle from the left-hand column.

## Database Configuration Assistant Improvements

Database Configuration Assistant has been redesigned to include database definitions saved as templates. The templates can generate databases. Users can define new templates, modify existing templates, or use the ones Oracle provides. When creating a database with Database Configuration Assistant, users can include new Sample Schemas provided by Oracle.

## Oracle Internet Directory Administration Improvements

Administration of Oracle Internet Directory replication server has been improved with the addition of new replication queue management and reconciliation tools.

## Using Oracle Database on Windows 2000

There are some differences between using Oracle Database on Windows 2000 and Windows NT 4.0. For more information, see [Appendix E, "Using Oracle Database on Windows 2000"](#).

## CONNECT INTERNAL Not Supported

CONNECT INTERNAL and CONNECT INTERNAL/PASSWORD are not supported in Oracle9i. Use the following instead:

```
CONNECT / AS SYSDBA
```

```
CONNECT username/password AS SYSDBA
```

## Server Manager Not Supported

Server Manager is not supported in Oracle9i. Use SQL\*Plus instead. Most Server Manager scripts should work in a SQL\*Plus environment, but some scripts may need to be modified.



---

---

# Oracle Database Architecture on Windows

This chapter describes how Oracle Database architecture takes advantage of some of the more advanced [services](#) in Windows operating systems.

This chapter contains these topics:

- [Oracle Database on Windows Architecture](#)
- [Oracle Database Scalability on Windows](#)
- [Oracle Database Integration with Windows](#)
- [Other Sources of Information](#)

## Oracle Database on Windows Architecture

Oracle Database on Windows is a stable, reliable, and high performing system upon which to build applications. Each release of the database provides new platform-specific features for high performance on Windows.

Oracle Database operates the same way on Windows as it does on other platforms. The architecture offers several advantages on Windows, such as:

- [Thread-Based Architecture](#)
- [File I/O Enhancements](#)
- [Raw File Support](#)

### Thread-Based Architecture

The internal **process** architecture of Oracle Database is **thread**-based. Threads are objects within a process that run program instructions. Threads allow concurrent operations within a process so that a process can run different parts of its program simultaneously on different processors. A thread-based architecture provides the following advantages:

- Faster context switching
- Simpler **System Global Area** allocation routine, because it does not require use of shared memory
- Faster spawning of new connections, because threads are created more quickly than processes
- Decreased memory usage, because threads share more data structures than processes

Internally, the code to implement the thread model is compact and separate from the main body of Oracle Database code. Exception handlers and routines track and de-allocate resources. They add robustness, with no downtime because of resource leaks or an ill-behaved program.

Oracle Database is not a typical Windows process. On Windows, an Oracle Database **instance** (threads and memory structures) is a Windows service: a background process registered with the operating system. The service is started by Windows and requires no user interaction to start. This enables the database to open automatically at startup.

When running multiple Oracle Database instances on Windows, each instance runs its own Windows service with multiple component threads. Each thread may be

required for the database to be available, or it may be optional and specific to certain platforms. The background processes read and write from various datafiles, depending on your configuration. Oracle Database architecture on Windows is illustrated in [Figure 1-1](#). Examples of optional and required threads on Windows are listed in [Table 1-1](#).

**Figure 1-1 Oracle Database Architecture on Windows**

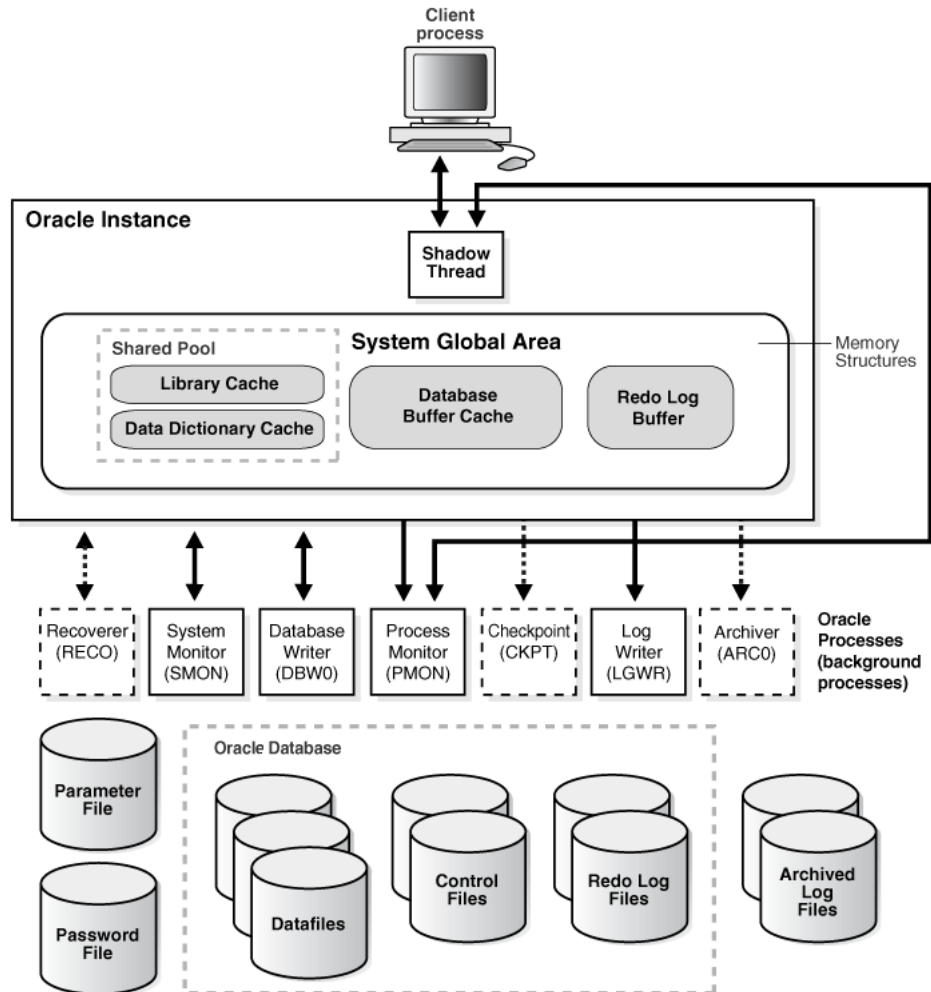

**Table 1–1 Required and Optional Oracle Database Threads**

Oracle Database Thread	Description	Required/Optional
DBW0	database writer	Required
LGWR	log writer	Required
PMON	process monitor	Required
SMON	system monitor	Required
CKPT	checkpoint process (thread on Windows) that runs by default on Windows	Optional
ARCH0	archive process (or thread on Windows)	Optional
RECO	distributed recovery background process	Optional

---

**Note:** You can view running background processes by issuing the following query:

```
SQL> select * from v$bgprocess where paddr <> '00' ;
```

---

Oracle Database for Windows is supplied as a set of executables and dynamic link libraries (DLLs). Executable images can be modified using ORASTACK to change the size of the stack used by the threads of the Oracle Database process. (Oracle recommends you use this tool only under the guidance of Oracle Support Services.)

## File I/O Enhancements

Oracle Database supports 64-bit file I/O to allow use of files larger than 4 gigabytes (GB). In addition, physical and logical raw files are supported as data, log, and **control files** to support Oracle Real Application Clusters on Windows and for those cases where performance needs to be maximized.

All Oracle Database file I/O routines support 64-bit file offsets, meaning there are no 2 GB or 4 GB file size limitations when it comes to data, log, or control files, as there are on some other platforms. In fact, the limitations that are in place are generic Oracle Database limitations across all platforms. These limits include 4 million database blocks for each file, 16KB maximum block size, and 64K files for each database. If these values are multiplied, then maximum file size for a database file on Windows is 64 GB, and maximum total database size supported (with 16KB database blocks) is 4 petabytes.

## Raw File Support

Windows supports raw files, similar to UNIX. Using raw files for database or log files can have a slight performance gain. Raw files are unformatted disk partitions that can be used as one large file. Raw files have the benefit of no file system overhead, because they are unformatted partitions. However, standard Windows commands do not support manipulating or backing up raw files. As a result, raw files are generally used only by very high-end installations and by Oracle Real Application Clusters, where they are required.

To Oracle Database, raw files are no different from other Oracle Database files. They are treated in the same way by Oracle Database as any other file and can be backed up and restored through Recovery Manager or OCOPI.

## Oracle Database Scalability on Windows

Features in Oracle Database and in the Windows operating system work together to help increase scalability, throughput, and database capacity. These features include:

- [Support for Very Large Memory \(VLM\) Configurations](#)
- [4 GB RAM Tuning \(4GT\)](#)
- [Large User Populations](#)

## Support for Very Large Memory (VLM) Configurations

Oracle Database for Windows supports Very Large Memory (VLM) configurations in Windows 2000 and Windows XP, which allows Oracle Database to access more than the 4 gigabyte (GB) of RAM traditionally available to Windows applications.

---

---

**Note:** This feature is not supported on Windows NT, and it is available on Windows 2000 and Windows XP only with Intel Pentium II and Pentium III Xeon 32-bit processors.

---

---

Specifically, Oracle Database uses Address Windowing Extensions (AWE) built into Windows 2000 and Windows XP to access more than 4 GB of RAM.

The requirements for taking advantage of this support are:

1. The computer on which Oracle Database is installed must have more than 4 GB of memory.

2. The operating system must be configured to take advantage of Physical Address Extensions (PAE) by adding the /PAE switch in `boot.ini`. See Microsoft Knowledge Base article Q268363 for instructions on modifying `boot.ini` to enable PAE.
3. It is advisable (though not necessary) to enable 4GT support by adding the /3GB parameter in `boot.ini`. See Microsoft Knowledge Base article Q171793 for additional requirements and instructions on modifying `boot.ini` to enable 4GT.
4. The user account under which Oracle Database runs (typically the LocalSystem account), must have the "Lock memory pages" Windows 2000 and Windows XP privilege.
5. `USE_INDIRECT_DATA_BUFFERS=TRUE` must be present in the initialization parameter file for the database instance that will use VLM support. If this parameter is not set, then Oracle Database 10g behaves in exactly the same way as previous releases.
6. Initialization parameters `DB_BLOCK_BUFFERS` and `DB_BLOCK_SIZE` must be set to values you have chosen for Oracle Database.

---

**Note:** The total number of bytes of database buffers (that is, `DB_BLOCK_BUFFERS` multiplied by `DB_BLOCK_SIZE`) is no longer limited to 3 GB.

Dynamic SGA and multiple block size are not supported with VLM. When VLM is enabled, the following new buffer cache parameters are not supported:

- `DB_CACHE_SIZE`
- `DB_2K_CACHE_SIZE`
- `DB_4K_CACHE_SIZE`
- `DB_8K_CACHE_SIZE`
- `DB_16K_CACHE_SIZE`
- `DB_32K_CACHE_SIZE`

To select the block size for the instance, use the initialization parameter `DB_BLOCK_SIZE`. The buffer cache size is set by the initialization parameter `DB_BLOCK_BUFFERS`.

---



7. Registry parameter `AWE_WINDOW_MEMORY` must be created and set in the appropriate key for your Oracle home. This parameter is specified in bytes and has a default value of 1 GB. `AWE_WINDOW_MEMORY` tells Oracle Database how much of its 3 GB address space to reserve for mapping in database buffers.

This memory comes from the 3 GB virtual address space in Oracle Database, so its value must be less than 3 GB. Setting this parameter to a large value has the effect of using more of the address space for buffers and using less AWE memory for buffers. However, since accessing AWE buffers is somewhat slower than accessing virtual address space buffers, Oracle recommends that you tune these parameters to be as large as possible without adversely limiting database operations.

In general, the higher `AWE_WINDOW_MEMORY` is set, the fewer connections and memory allocations will be possible for Oracle Database. The lower `AWE_WINDOW_MEMORY` is set, the lower the performance.

8. Once this parameter is set, Oracle Database can be started and will function exactly the same as before except that more database buffers are available to the instance. In addition, disk I/O may be reduced because more Oracle Database data blocks can be cached in the **System Global Area** (SGA).

---

---

**Note:** Registry parameter `VLM_BUFFER_MEMORY`, which enabled VLM configurations in Windows NT in Oracle8i release 2 (8.1.6), is not supported in Oracle Database 10g.

---

---

## VLM Instance Tuning

VLM configurations improve database performance by caching more database buffers in memory. This reduces disk I/O compared to configurations without VLM. VLM support in Oracle Database 10g has been re-written to integrate very closely with Oracle Database. Compared to Oracle8i release 2 (8.1.6), VLM users should see better performance with the newer implementation.

Tuning for VLM is no different than tuning for configurations without VLM. It is an iterative task that begins by selecting appropriate `DB_BLOCK_SIZE` and `DB_BLOCK_BUFFERS` initialization parameters for the application being supported.

---

---

**Note:** Oracle Database 10g VLM configurations do not support multiple database block sizes.

---

---

`AWE_WINDOW_MEMORY`, a new registry parameter specific to VLM, tells Oracle Database how much of its address space to reserve for mapping in database buffers. It defaults to a value of 1 GB, which should be suitable for most installations. If `DB_BLOCK_SIZE` is large, however, the default `AWE_WINDOW_MEMORY` value of 1 GB may not be sufficient to start the database.

Increasing the value of `AWE_WINDOW_MEMORY` will improve performance, but it will also limit the amount of memory available for other Oracle Database threads (like foreground threads). Clients may see "out of memory" errors if this value is set too large. As a general guideline, increase the `AWE_WINDOW_MEMORY` registry value by 20 percent.

For example, if `DB_BLOCK_SIZE` is set to 8 KB, `AWE_WINDOW_MEMORY` is set to 1 GB, and the number of LRU latches is set to 32 (16 processor computer), then database startup fails with out of memory errors 27102 and 34. Increasing the value of `AWE_WINDOW_MEMORY` to 1.2 GB fixes the problem.

Having a large cache in a VLM configuration may also slow down database writer (DBWR) threads. Having more DBWR threads will distribute work required to identify and write buffers to disk and will distribute I/O loads among threads. Initialization parameter `DB_WRITER_PROCESSES` enables you to configure multiple database writer threads.

A large cache can also introduce contention on the LRU (least recently used) [latch](#). On symmetric multiprocessor (SMP) systems, Oracle Database sets the number of LRU latches to a value equal to one half the number of processors on the system. You can reduce contention on such configurations by increasing the number of LRU latches to twice (or four times) the number of processors on the system.

**See Also:** *Oracle Database Performance Tuning Guide* for more information on instance tuning

## 4 GB RAM Tuning (4GT)

The following Windows operating systems include a feature called 4 GB RAM Tuning (4GT):

- Windows Server 2003
- Windows 2000 Advanced Server
- Windows 2000 Datacenter Server
- Windows NT 4.0 Enterprise Edition

This feature allows memory-intensive applications running on Oracle Database Enterprise Edition to access up to 3 GB of memory, as opposed to the standard 2 GB in previous operating system versions. 4GT provides a tremendous benefit: 50 percent more memory is available for database use, increasing SGA sizes or connection counts.

## Large User Populations

Several features allow Oracle Database to support an increasingly large number of database connections on Windows:

- Oracle Database [Shared Server Process](#), which limits the number of threads needed in the Oracle Database process, supports over 10,000 simultaneous connections to a single database instance.
- [Oracle Net](#) multiplexing and connection pooling features allow a large configuration to connect more users to a single database instance.
- Oracle Real Application Clusters raises connection counts dramatically by allowing multiple server computers to access the same database files, increasing the number of user connections by tens of thousands, as well as increasing throughput.

---

---

**Note:** Oracle Real Application Clusters is not supported on Windows XP.

---

---

## Oracle Database Integration with Windows

Oracle Database is increasingly integrated with Windows, easing maintenance and improving enterprise-level deployment in security, directory, and transaction services. Integration features in Oracle Database include:

- [Oracle PKI Integration with Windows](#)
- [Oracle Services for Microsoft Transaction Server](#)
- [Oracle Fail Safe Integration with Windows](#)
- [Oracle Real Application Clusters Integration with Windows](#)

## Oracle PKI Integration with Windows

Oracle Advanced Security includes **Oracle PKI** (public key infrastructure) integration for authentication and single sign-on. You can integrate Oracle-based applications with the PKI authentication and encryption framework, using Oracle Wallet Manager.

## Oracle Services for Microsoft Transaction Server

**Microsoft Transaction Server** (MTS) is used in the middle tier as an application server for **COM/COM+** objects and transactions in distributed environments. In Windows 2000 and Windows XP it is part of COM+. Oracle Services for Microsoft Transaction Server allows Oracle Database to be used as a resource manager in Microsoft Transaction Server-coordinated transactions, providing strong integration between Oracle solutions and Microsoft Transaction Server. Oracle Services for Microsoft Transaction Server can operate with Oracle Database running on any operating system.

Oracle Database takes advantage of a native implementation and also stores **recovery** information in Oracle Database itself. Oracle Services for Microsoft Transaction Server allows development in all industry-wide data access interfaces, including Oracle Objects for OLE (OO4O), **Oracle Call Interface** (OCI), ActiveX Data Objects (ADO), OLE DB, and Open Database Connectivity (ODBC). The Oracle APIs, OO4O and OCI, offer greatest efficiency.

## Oracle Fail Safe Integration with Windows

Oracle Fail Safe ensures that Oracle Database (and also other Oracle and third-party applications) can be configured and managed for high availability on Windows clusters. An **instance** runs on only one node at a time.

A cluster is a group of independent computing systems that operates as a single virtual system, eliminating individual host systems as points of failure. Oracle Fail Safe works with Microsoft Cluster Server to ensure that if a failure occurs on one cluster system, then workloads running on that system fail over quickly and automatically to a surviving system. Oracle Database combined with Oracle Fail Safe on a Windows cluster ensures protection from both hardware and software failures.

For well-configured solutions, Oracle Fail Safe ensures a surviving system to be operational in less than a minute, even for heavily-used databases.

---

---

**Note:** Windows XP does not support the clustering technology found in Microsoft Cluster Server. Therefore, Oracle Fail Safe Server, which integrates with Microsoft Cluster Server, is not supported on Windows XP. Oracle Fail Safe Manager Console is supported.

---

---

**See Also:** Your Oracle Fail Safe documentation set, available on separate media in the Oracle CD-ROM package

## Oracle Real Application Clusters Integration with Windows

Oracle Real Application Clusters are integrated with Microsoft Cluster Server clusters deployed on all Windows operating systems that support clustering. This enhances high availability features of Oracle Real Application Clusters by offering:

- Optional automatic restarts of a failed instance or **listener** in a cluster
- Detection and resolution of instance hangs
- Elimination of connect-time failover TCP/IP timeout delays for new connection requests
- Use of user-written scripts after database state (online/offline) changes

## Other Sources of Information

**See Also:**

- [Appendix F, "Oracle Database Windows/UNIX Differences"](#)
- [Chapter 3, "Database Tools on Windows"](#), for Oracle Database integration with Windows tools
- [Chapter 15, "Developing Applications for Windows"](#), for more Oracle Database integration with Windows features



---

---

# Multiple Oracle Homes and Optimal Flexible Architecture

This chapter describes **multiple Oracle homes** and **Optimal Flexible Architecture (OFA)** for Oracle Database for Windows.

This chapter contains these topics:

- [Introduction to Multiple Oracle Homes and OFA](#)
- [Multiple Oracle Homes Overview](#)
- [Changing the Value of PATH](#)
- [Exiting Oracle Universal Installer After Entering Name and PATH](#)
- [Setting Variables in the Environment or the Registry](#)
- [Optimal Flexible Architecture Overview](#)
- [Differences Between Directory Trees by Release](#)
- [OFA Directory Naming Conventions](#)
- [OFA and Multiple Oracle Home Configurations](#)
- [Increasing Reliability and Performance](#)
- [Comparison Between OFA on Windows and UNIX](#)

## Introduction to Multiple Oracle Homes and OFA

When you install Oracle Database, you are installing one of the largest applications that your computer can support. Using multiple Oracle homes and OFA provides many advantages when administering large databases. The following advantages are most important:

- Structured organization of directories and files and consistent naming used for database files simplify database administration.
- Distribution of I/O across multiple disks prevents performance bottlenecks caused by multiple read or write commands issued simultaneously to a single drive.
- Distribution of applications across multiple disks safeguards against database failures.
- Login home directories are not at risk when database administrators add, move, or delete Oracle home directories.
- Multiple versions of application software can execute concurrently.
- Software upgrades can be tested in an Oracle home in a separate directory from the Oracle home where your production database is located.

---

---

**Note:** Oracle recommends that you test software upgrades on a separate server from your production database server

---

---

## Multiple Oracle Homes Overview

This section includes the following topics:

- [What Is an Oracle Home?](#)
- [Benefit of Using Multiple Oracle Homes](#)
- [One-Listener Support of Multiple Oracle Homes](#)

## What Is an Oracle Home?

An Oracle home corresponds to the environment in which Oracle products run. This environment includes the following:

- Location of installed product files
- `PATH` variable pointing to binary files of installed products



- Registry entries
- Service names
- Program groups

Oracle homes also have a name associated with them, which you specify along with their location during installation.

## Benefit of Using Multiple Oracle Homes

The main benefit of using multiple Oracle homes is that you can run multiple releases of the same products concurrently. For example, you can test an Oracle Database patch before you run your production Oracle Database against it.

## One-Listener Support of Multiple Oracle Homes

You can use one listener for spawning connections to databases for multiple Oracle homes. Simply add each **system identifier** to the `SID_LIST` section in the `ORACLE_BASE\ORACLE_HOME\network\admin\listener.ora` file.

Because the SID is unique to a system across different Oracle homes, the listener can spawn the database **thread** for a specific SID in the correct Oracle home, and the `ORACLE_HOME` parameter (used in UNIX environments only) is not needed in the **listener.ora** file.

---

---

**Note:** There may be multiple `listener.ora` files on your computer, one for each Oracle home. To ensure that you use the correct `listener.ora` file, check the Oracle home name in the listener service. See "[Managing Oracle Database Services](#)" on page 6-2 for information on verifying service names.

---

---

## Changing the Value of PATH

Unless you specify otherwise at installation time, the Oracle home in which you installed products most recently is the first directory listed in your `PATH` (primary home). As such, it has priority over the other Oracle home entries in your `PATH`.

If you start a product from the command prompt, then the release of the product started is the one in the Oracle home listed first in your `PATH`, unless you specifically start a different release of the product by one of the following methods:

- Specifying the full directory path name to the release of the product you want to use at the command prompt
- Changing to the directory that contains the executable you want to use
- Changing your `PATH` so that the first entry points to binary files for the product release you want to use

You have three options for changing the value of `PATH`:

- [Changing the Value of PATH Using Oracle Universal Installer](#)
- [Changing the Value of PATH at the System Level](#)

The new value exists until you change the value of `PATH` again.

- [Changing the Value of PATH at the Command Prompt](#)

The new value reverts to its previous value when you quit the session.

---

---

**Note:** The first two methods of changing the value of `PATH` are only valid if you are a member of the Administrators group. After you have changed the value of `PATH`, you must open a new command prompt window to make it active. The change is not reflected in already-opened windows.

---

---

## Changing the Value of PATH Using Oracle Universal Installer

Oracle Universal Installer enables you to edit your environment `PATH` to make a specific Oracle home directory your primary home when you have multiple active Oracle home directories on a single computer.

1. Choose **Start > Programs > Oracle > HOME\_NAME > Oracle Installation Products > Universal Installer**.

The Oracle Universal Installer: Welcome window appears.

2. Click **Installed Products**.
3. Select the **Environment** tab.
4. Select a primary Oracle home and use the **up arrow** to move it to the top of the list.
5. Click **Apply**.
6. Click **Close**.

---

**Note:** This procedure requires Oracle Universal Installer release 2.3.0.5.0a or newer.

---

## Changing the Value of PATH at the System Level

PATH is an environment variable, and the procedure for changing its value depends on your operating system.

**See Also:** Your Windows documentation for information on environment variables

## Changing the Value of PATH at the Command Prompt

At the command prompt, enter:

```
C:\> set PATH=PATHNAME;%PATH%
```

where *PATHNAME* is the full path to binary files for the products you want to use. This change is valid for the current session only. If you want to change the value of your PATH permanently, then use Oracle Universal Installer or change the value of PATH at the system level. Both methods are described earlier in this section.

## Exiting Oracle Universal Installer After Entering Name and PATH

If you have to exit Oracle Universal Installer unexpectedly after you have entered the name and path for an Oracle home (for example, because there is no more disk space in the path you specified), then you cannot specify a different path until you delete the *KEY\_HOME\_NAME* key corresponding to that Oracle home from the registry. To do this:

1. Read the value of parameter *ORACLE\_HOME\_NAME* for each *KEY\_HOME\_NAME* subkey in key *HKEY\_LOCAL\_MACHINE\SOFTWARE\ORACLE* until you find the value that matches the name of the Oracle home you must delete.
2. Delete subkey *KEY\_HOME\_NAME* you just located.

**See Also:** [Chapter 14, "Configuration Parameters and the Registry"](#) for more information on registry keys and subkeys

## Setting Variables in the Environment or the Registry

Variables set in the environment always override the value of equivalent variables set in the registry. The following section describes consequences of setting two of the most commonly-used environment variables, `ORACLE_HOME` and `TNS_ADMIN`.

### Setting `ORACLE_HOME`

Oracle recommends that you *never* set the `ORACLE_HOME` environment variable, because it is not required for Oracle products to function properly. If you set the `ORACLE_HOME` environment variable, then Oracle Universal Installer will unset it for you. Oracle products find the value of `ORACLE_HOME` at the location specified by the `ORACLE_BASE\ORACLE_HOME\bin\oracle.key` file. If you must set `ORACLE_HOME` in the environment for another reason, then you must take care to run software only from that Oracle home when the variable is set.

When you run an Oracle application from the command prompt, the first executable by that name found in the directory path runs. For example, `C:\> sqlplus`. Alternately, if you specify a full directory path, then the specified application runs. For example, `C:\oracle\ora82> sqlplus`.

If you modify the value of `PATH` using any of the three methods described in the previous section, then you can choose which release of an application is run from the command prompt. In sum, modifying the value of `PATH` indicates from which Oracle home to run executables at the command prompt, when no full directory path is specified.

Once an Oracle application starts, it looks for all environment variables first in the current environment and second in the registry key for the Oracle home from which the application is running.

The application knows where it is running from by calling Windows to obtain the executable's path name and then parsing the path name to get the directory from which it is running. In the `ORACLE_BASE\ORACLE_HOME\bin` directory where the executable resides, there is a file called `oracle.key`. This file specifies where in the registry to look for variables when applications from that particular Oracle home are run.

For example, if you run `C:\oracle\ora82\bin\sqlplus.exe`, then `sqlplus.exe` looks in `C:\oracle\ora82\bin\oracle.key` to find out where to look for its registry variables. If the `oracle.key` file does not exist (for version 7 and some version 8 Oracle homes), then Oracle uses `HKEY_LOCAL_MACHINE\SOFTWARE\ORACLE` to locate the registry variables.

In a typical case, there are no Oracle variables (that is, `ORACLE_HOME`) set in the environment. Any applications run from an Oracle8 release 8.0.5 or later Oracle home look in the `oracle.key` file in that Oracle home and find their variables (including `ORACLE_HOME`) in the correct registry key. Likewise for Oracle Database 10g, the Oracle home that gets priority depends on the `PATH`, but regardless of the `PATH` setting, all software works correctly.

### **Consequences of Setting `ORACLE_HOME`**

If you set `ORACLE_HOME` in the environment, then software run from another Oracle home will not work reliably. Conflict occurs when you set `ORACLE_HOME` to point to one Oracle home directory, then attempt to run applications from a second Oracle home. These applications first check for any environment variable settings (such as `ORACLE_HOME`), before checking the registry through the `oracle.key` file. Because `ORACLE_HOME` is set, the applications in the second Oracle home attempt to use files in the first Oracle home, causing a conflict.

For example, suppose you have Oracle8 release 8.0.5 installed in `C:\orant` and Oracle Database 10g installed in `C:\oracle\ora10`. Suppose further that `ORACLE_HOME` is set to `C:\orant` in the environment. If you run an application from `C:\oracle\ora10\bin`, then that application first looks in the environment for all variables before looking at its `oracle.key` file. So an application run from your Oracle Database 10g Oracle home runs with `ORACLE_HOME=C:\orant`. Therefore, anything that the application uses `ORACLE_HOME` for will be looked for in `C:\orant`, where it may not exist. Examples include message files (`*.msb`), SQL scripts (`.sql`), and any other files opened by the application and based off `ORACLE_HOME`.

Note that the same behavior occurs on UNIX. If you run an application from Oracle home number 1 with `ORACLE_HOME=OracleHome number 2` in the environment, then the same behavior can be observed.

## **Setting `TNS_ADMIN`**

Oracle software looks for `TNS_ADMIN` in one location in the registry (depending upon the type of Oracle home installed). If you installed software into the default Oracle home, then any software running from that Oracle home will look in `HKEY_LOCAL_MACHINE\SOFTWARE\ORACLE`. If you installed a new-style (8.0.4 or later) multiple Oracle home, then the Oracle software looks in `HKEY_LOCAL_MACHINE\SOFTWARE\ORACLE\HOMEID`.

The environment always overrides the registry, so if `TNS_ADMIN` is set in the environment, then that takes precedence over the `TNS_ADMIN` setting in the registry.

## Optimal Flexible Architecture Overview

Oracle Optimal Flexible Architecture (OFA) is a set of file naming and placement guidelines for Oracle software and databases. It can also be thought of as a set of good habits to adopt when organizing Oracle directories and files on your computer. All Oracle products on CD-ROM are OFA-compliant; that is, Oracle Universal Installer places Oracle products in directory locations that follow OFA guidelines. Although using OFA is not a requirement, Oracle recommends that you use it if your database will grow in size, or if you plan to have multiple databases.

The aim of OFA is to prevent an entire class of problems that can occur when you have different releases of Oracle software and multiple, growing databases on your computer. OFA is designed to provide significant benefits:

- Easier maintenance of Oracle software and databases through standard file organization
- Greater reliability through data spanning multiple physical drives
- Higher performance through decreased I/O contention for disks

For example, Oracle Universal Installer now separates Oracle software executables from database files. Previously, database files were placed in *ORACLE\_HOME*\database, a subdirectory of the Oracle home directory that also contained Oracle software.

Using OFA, Oracle Universal Installer puts Oracle software in *ORACLE\_BASE*\*ORACLE\_HOME* and database files in *ORACLE\_BASE*\oradata. Now when you upgrade a database to the latest release, the new Oracle software executables will be placed in a different Oracle home directory. After you judge the upgrade successful, you can easily remove the old Oracle home directory and reclaim space, because the database does not reside there.

### Benefits of an OFA-Compliant Database

An OFA-compliant database has the following benefits:

- Easier database administration and management of database growth  
File system organization simplifies locating specific database files and adding database files as the database grows.
- Fewer performance bottlenecks

Disk contention decreases, because Oracle administration files, binary files, and datafiles that used to be on one disk can now reside in separate directories on separate disks.

- Safeguards against disk failures

By spreading files across more than one disk, disk failures impact as little data as possible.

- Support for concurrent execution of application software

Multiple releases of application software can run simultaneously, enabling testing and use of a new release of an application before abandoning the previous release. Transferring to a new release after an upgrade is simple for the database administrator and transparent for the user.

## Characteristics of an OFA-Compliant Database

An OFA-compliant database has the following characteristics:

- Independent subdirectories

Categories of files are separated into independent subdirectories so that files in one category are minimally affected by operations on files in other categories.

- Consistent naming conventions for database files

Database files are easily distinguishable from all other files. Files of one database are easily distinguishable from files of another database. Datafiles, **redo log files**, and **control files** are easily identifiable. Datafiles are clearly associated with a particular **tablespace**.

- Integrity of Oracle home directories

You can add, move, or delete Oracle home directories without having to revise applications that refer to them.

- Separation of administrative information for each database

The ability to distinguish administrative information about one database from that of another ensures a reasonable structure for the organization and storage of administrative data.

- Separation of tablespace contents

Tablespace free space fragmentation and I/O request contention are minimized, while administrative flexibility is maximized.

- Tuning I/O loads across all disks  
I/O loads are tuned across all disks, including disks storing Oracle data in raw devices, if needed.

## Differences Between Directory Trees by Release

OFA has necessitated changes to the Oracle Database directory tree. This section lists the differences.

### Top-Level Oracle Directory

When you install an Oracle8i release 8.1.3 or earlier release, all subdirectories are located under a top-level `ORACLE_HOME` directory that by default is `C:\orant`.

When you install an Oracle8i release 8.1.4 or later OFA-compliant database, all subdirectories are no longer under a top-level `ORACLE_HOME` directory. There is now a new top-level directory called **ORACLE\_BASE** of form `X:\oracle`, where `X` is any hard drive. If you install an OFA-compliant database using Oracle Universal Installer defaults, then `ORACLE_BASE` is `C:\oracle`.

`ORACLE_BASE` contains `\ORACLE_HOME` directories, `\oradata` directories (for database files), and `\admin` directories (for database administration files).

### Database Filenames

In Oracle8i release 8.1.3 and earlier releases, database files have the SID in the database filename. For example, the first control file is named `ctl1SID.ora`.

Beginning with Oracle8i release 8.1.4, database files no longer have the SID in the database filename. For example, the first control file is named `control01.ctl`. There is no need for the presence of the SID in the filename, because all the database files for a particular database are placed in `\oradata` under a directory called `DB_NAME` that is named for that database.

### Database Filename Extensions

In Oracle8i release 8.1.3 and earlier releases, all database files have the same ".ORA" extension.

In an OFA-compliant release, the convention of having ".ora" as the filename extension for database files is no longer used. Database filenames now have more meaningful extensions. These are:



- .ctl for control files,
- .log for log files
- .dbf for datafiles.

## OFA Directory Naming Conventions

OFA uses directory naming conventions that make it easy to identify the precise Oracle home and database name that is associated with a set of files. This section describes the naming conventions used for top-level directories of an OFA-compliant database directory tree:

- [ORACLE\\_BASE Directory](#)
- [ORACLE\\_HOME Directory](#)
- [ADMIN Directory](#)
- [ORADATA Directory](#)
- [DB\\_NAME Directory](#)

### ORACLE\_BASE Directory

ORACLE\_BASE is the root of the Oracle directory tree. If you install an OFA-compliant database using Oracle Universal Installer defaults, then ORACLE\_BASE is X:\oracle where X is any hard drive. For example, C:\oracle.

If you are installing Oracle Database for Windows on a computer with no other Oracle software installed, then you can change ORACLE\_BASE before running Oracle Universal Installer. Most users will not need or want to do this.

Do not change the value of ORACLE\_BASE after you run Oracle Universal Installer for the first time. If there is an existing ORACLE\_BASE and you change it, then there will be a conflict of Oracle base directories. If you create another ORACLE\_BASE when the original ORACLE\_BASE already exists, then certain tools and the database will not be able to find previously created files. They will look for them in the new ORACLE\_BASE instead of the original ORACLE\_BASE.

**See Also:** Your Windows documentation for instructions on editing environment variables

## ORACLE\_HOME Directory

The \ORACLE\_HOME directory is located beneath X:\ORACLE\_BASE and contains subdirectories for Oracle software executables and network files.

If you install Oracle Database for Windows on a computer with no other Oracle software installed and you use default settings, then the first Oracle home directory that you create is called \ora10.

## ADMIN Directory

Database administration files are stored in subdirectories of ORACLE\_BASE \admin\DB\_NAME. Names and brief descriptions of some of these subdirectories are:

```
\bdump      --background process trace files
\cdump      --core dump files
\create     --database creation files
\exp        --database export files
\pfile     --initialization parameter files
\udump     --user SQL trace files
```

## ORADATA Directory

Database files are stored in ORACLE\_BASE\ORADATA\DB\_NAME. Names and brief descriptions of these files are:

```
control01.ctl  --control file 1
control02.ctl  --control file 2
control03.ctl  --control file 3
system01.dbf   --SYSTEM tablespace datafile
temp01.dbf     --TEMP tablespace datafile
users01.dbf    --USERS tablespace datafile
*.dbf         --datafiles corresponding to each tablespace in your database
redo01.log     --redo log file group one, member one
redo02.log     --redo log file group two, member one
redo03.log     --redo log file group three, member one
```

---

---

**Note:** This directory structure allows for disk striping only on UNIX platforms. See "[Support for Symbolic Links on Windows](#)" on page 2-19.

---

---

## DB\_NAME Directory

DB\_NAME is the unique name for a particular database and has the same value as parameter DB\_NAME in the **initialization parameter file**. When you create a database, DB\_NAME can be no more than eight characters long and can contain only the following characters:

- Alphabetic characters
- Numbers
- Underscores (\_)
- Pound sign (#)
- Dollar sign (\$)

## OFA and Multiple Oracle Home Configurations

The following sections describe various OFA and multiple Oracle homes configurations.

### Specifying an ORACLE\_HOME Directory

To install an OFA-compliant database, you must specify an Oracle home directory in the Path field of Oracle Universal Installer. It is of the form:

```
X:\[PATHNAME]\oracle\HOME_NAME
```

where:

- X:\ is any hard drive. For example, C:\
- [PATHNAME] is an optional directory path name
- \oracle is a mandatory directory path name, unless you changed the value of registry key ORACLE\_BASE before performing the installation
- HOME\_NAME is the name of the Oracle home

The following are examples of OFA-compliant Oracle home directories:

- C:\test\oracle\ora10
- D:\oracle\ora10

## Installing a Default OFA Database: Example

1. Install any Oracle Database that supports OFA (Oracle Database 8.1.6 or later) on a computer with no other Oracle software installed and make sure that you accept default settings for the Oracle home (for example, `c:\oracle\ora81`).
2. Install any Oracle Database (for example, Oracle Database 10g) in a second Oracle home accepting the default settings.

Table 2–1 shows the default OFA database settings.

**Table 2–1 Default OFA Database Settings**

Setting	Value
<code>ORACLE_BASE</code>	<code>C:\oracle</code> (same for all Oracle homes)
Oracle home 1	<code>C:\oracle\ora81</code>
Oracle home 2	<code>C:\oracle\ora10</code>

## Installing a Nondefault OFA Database: Example 1

1. Install any Oracle Database that supports OFA (Oracle Database 8.1.6 or later) on a computer with no other Oracle software installed and change default Oracle Universal Installer settings for the first Oracle home (for example, from `C:\oracle\ora81` to `X:\xyz`).
2. Install any Oracle Database (for example, Oracle Database 10g) in a second Oracle home and change default Oracle Universal Installer settings for the second Oracle home (for example, from `C:\oracle\ora10` to `Y:\abc`).

Table 2–2 shows the nondefault OFA database settings for example 1.

**Table 2–2 Nondefault OFA Database Settings: Example 1**

Setting	Value
<code>ORACLE_BASE</code>	<code>X:\xyz</code> for first Oracle home; <code>Y:\abc</code> for second Oracle home
Oracle home 1	<code>X:\xyz</code>
Oracle home 2	<code>Y:\abc</code>

The resulting directory tree would look similar to this:

```
X:\xyz
  \admin
```

```
        \DB_NAME1
        \DB_NAME2
    \bin
    \network
    \oradata
        \DB_NAME1
            control01.ctl
            control02.ctl
            control03.ctl
            indx01.dbf
            rbs01.dbf
            system01.dbf
            temp01.dbf
            users01.dbf
            redo01.log
            redo02.log
            redo03.log
        \DB_NAME2
Y:\abc
    \admin
        \DB_NAME1
        \DB_NAME2
    \bin
    \network
    \oradata
        \DB_NAME1
            control01.ctl
            control02.ctl
            control03.ctl
            indx01.dbf
            rbs01.dbf
            system01.dbf
            temp01.dbf
            users01.dbf
            redo01.log
            redo02.log
            redo03.log
        \DB_NAME2
```

## Installing a Nondefault OFA Database: Example 2

1. Install any Oracle Database that supports OFA (Oracle Database 8.1.6 or later) on a computer with no other Oracle software installed and change default Oracle Universal Installer settings for the first Oracle home (for example, from C:\oracle\ora81 to X:\xyz\oracle\abc).
2. Install any Oracle Database and change default Oracle Universal Installer settings for the second Oracle home (for example, from C:\oracle\ora10 to X:\pqr).

Table 2–3 shows the nondefault OFA database settings for example 2.

**Table 2–3 Nondefault OFA Database Settings: Example 2**

Setting	Value
ORACLE_BASE	X:\xyz\oracle (same for both Oracle homes)
Oracle home 1	X:\xyz\oracle\abc
Oracle home 2	X:\pqr

The resulting directory tree would look similar to this:

```
X:\pqr                                --Oracle home 2
  \bin
  \network
X:\xyz
  \oracle                              --ORACLE_BASE for both Oracle homes
  \abc                                  --Oracle home 1
    \bin
    \network
  \admin
  \DB_NAME1
  \adhoc
  \bdump
  \cdump
  \create
  \exp
  \pfile
  \udump
  \DB_NAME2
  \...
  \oradata
  \DB_NAME1
```

```
control01.ctl  
control02.ctl  
control03.ctl  
indx01.dbf  
rbs01.dbf  
system01.dbf  
temp01.dbf  
users01.dbf  
redo01.log  
redo02.log  
redo03.log  
\DB_NAME2
```

## Increasing Reliability and Performance

One of the basic goals of OFA is to increase reliability and performance by distributing I/O loads across different physical drives. Two ways to do that are:

- [Disk Mirroring](#)
- [Disk Striping](#)

### Disk Mirroring

Oracle Database log files and database files can be separated and treated with different levels of hardware reliability. Oracle Database log files are highly reliable to start with, because they are stored redundantly. Creating similar reliability for database files may require you to duplicate all of your data, using disk mirrors.

Disk mirroring usually involves two or more identical drives and either a hardware controller or Windows Disk Administrator. If one disk fails, then the other disk(s) can be used to recover data that would otherwise be lost. Using one of the disks to recover lost data may involve "breaking" the mirror. If the mirror breaks, then you must build a new mirror.

Disk mirroring is part of some levels of Redundant Array of Independent Disks (RAID) configurations, provided by the disk controller. The RAID level determines the amount of redundancy. Some RAID levels can use the "hot swapping" feature, which means that you can replace a bad disk with a good one without turning off the computer or losing functionality.

## Disk Striping

How you set up disks for use in a database depends on the number of disks and the type of hard disk controllers available. If the hard disk controllers support both striping and mirroring, then Oracle recommends you configure the controllers to support striping.

Some controllers are configured at system startup time by issuing a keyboard sequence that brings up configuration programs written by the controller manufacturer. One goal is to stripe as many drives together as possible by configuring the controllers. Each stripe shows up as one logical device.

Striping provides significant performance advantages. All the space from the striped drives appears as a single logical drive. Furthermore, the space is used by interlacing "stripes" of space from all of the disks in the stripe. This means that a large file uses some space from the first disk, then some from the second disk and so on to the last disk and then starting back at the first disk again. Each file can be spread over all of the striped disks. Data in such a file may be accessed randomly by more than one CPU without contention.

Controllers that support striping usually provide caching as well. This means that data can be written to the controller and cached and saved for a time in storage not on the disk. Data that is read can be cached on the controller in a similar fashion. Read caching is not necessary for Oracle Database, because all database reads are cached already in the **System Global Area** (SGA). The value of parameter `DB_CACHE_SIZE` in the initialization parameter file (`init.ora`) determines the buffer size that can be used in the SGA. This value also configures Oracle Database on startup.

## Using Raw Partitions for Tablespaces

A raw partition is a portion of a physical disk that is accessed at the lowest possible level. I/O of a raw partition improves performance by approximately 5% to 10% compared to I/O of a partition containing a file system. Therefore, Oracle encourages you to use **raw partitions** for your tablespace files.

## Comparison Between OFA on Windows and UNIX

You implement OFA on Windows and UNIX in the same way. However, differences exist with regard to the following:

- [Directory Naming](#)
- [ORACLE\\_BASE Directory](#)



- [Support for Symbolic Links on Windows](#)

**See Also:** Your UNIX operating system-specific administrator's reference for information about OFA on UNIX

## Directory Naming

Top-level names of the OFA directory tree differ between Windows and UNIX. However, main subdirectory and filenames are the same on both operating systems.

## ORACLE\_BASE Directory

On Windows, ORACLE\_BASE is associated with an Oracle home directory. ORACLE\_BASE is defined in the registry (for example, in HKEY\_LOCAL\_MACHINE\SOFTWARE\ORACLE\KEY\_HOME\_NAME).

On UNIX, ORACLE\_BASE is associated with a UNIX user's environment.

## Support for Symbolic Links on Windows

The goal of OFA is to place all Oracle software under one ORACLE\_BASE directory and to spread files across different physical drives as your databases increase in size.

On UNIX, although everything seems to be in one directory on the same hard drive, files can be on different hard drives if they are symbolically linked or have that directory as a mount point.

Windows currently does not support symbolic links, so datafiles will not all show up under a single directory like on UNIX. Instead, you may have `oradata` directories on multiple drives, with datafiles in each one. In this way, you still get OFA benefits, even though datafiles are not all visible in a single directory.

Oracle recommends that you use one logical drive to store your database administration files and that you place other files, as needed, on other logical drives in an `oradata\DB_NAME` directory.

In the following example, there are four logical drives for a database named `prod`:

- `C:\` contains an Oracle home and database administration files.
- `F:\` contains redo log files. (`F:\` drive could also represent two physical drives that have been striped to increase performance.)
- `G:\` contains one of the control files and all **tablespace** files. (`G:\` drive could also use a RAID Level-5 configuration to increase reliability.)

- H:\ contains the second control file.

The directory structure would look similar to this:

```

C:\oracle          --First logical drive
  \ora10           --Oracle home
    \bin           --Subtree for Oracle binaries
    \network       --Subtree for Oracle Net
    \...
  \admin           --Subtree for database administration files
    \prod          --Subtree for prod database administration files
      \adhoc       --Ad hoc SQL scripts
      \adump       --Audit files
      \bdump       --Background process trace files
      \cdump       --Core dump files
      \create      --Database creation files
      \exp         --Database export files
      \pfile       --Initialization parameter file
      \udump       --User SQL trace files

F:\oracle          --Second logical drive (two physical drives, striped)
  \oradata         --Subtree for Oracle Database files
    \prod          --Subtree for prod database files
      redo01.log   --Redo log file group one, member one
      redo02.log   --Redo log file group two, member one
      redo03.log   --Redo log file group three, member one

G:\oracle          --Third logical drive (RAID level 5 configuration)
  \oradata         --Subtree for Oracle Database files
    \prod          --Subtree for prod database files
      control01.ctl --Control file 1
      indx01.dbf   --Index tablespace datafile
      rbs01.dbf    --Rollback tablespace datafile
      system01.dbf --System tablespace datafile
      temp01.dbf   --Temporary tablespace datafile
      users01.dbf  --Users tablespace datafile

H:\oracle          --Fourth logical drive
  \oradata         --Subtree for Oracle Database files
    \prod          --Subtree for prod database files
      control02.ctl --Control file 2
  
```

---

---

## Database Tools on Windows

Oracle Database for Windows includes various tools to perform database functions. This chapter describes preferred tools to perform common database administration tasks and explains how tools can be started.

Unless otherwise noted, features described in this guide are common to Oracle Database Enterprise Edition, Oracle Database Standard Edition, and Oracle Database Personal Edition.

This chapter contains these topics:

- [Choosing a Database Tool](#)
- [Starting Database Tools](#)
- [Using SQL\\*Loader](#)
- [Using Windows Tools](#)
- [Optional Windows Diagnostic and Tuning Utilities](#)

## Choosing a Database Tool

Database tools is a collective term for tools, utilities, and assistants that you can use to perform database administration tasks. Some database tools perform similar tasks, though no one database tool performs all database administration tasks. The following sections indicate which database tools can be used on particular operating systems and preferred tools to use for common database administration tasks.

---

---

**Note:** Oracle Server Manager is no longer shipped as of Oracle9i release 2 (9.2). All Server Manager text and examples have been replaced with SQL\*Plus equivalents.

Additionally, connecting to the database as `CONNECT INTERNAL` is no longer supported.

```
SQL> CONNECT INTERNAL/password@tnsalias
```

has been replaced by:

```
SQL> CONNECT SYS/password@tnsalias AS SYSDBA
```

---

---

## Database Tools and Operating System Compatibility

Almost all database tools are available on all supported versions of Windows. The exceptions are:

- Oracle Advanced Security includes Enterprise Security Manager Console and Oracle Wallet Manager. These are available only with Oracle Database Enterprise Edition and Oracle Database Personal Edition, and not Oracle Database Standard Edition. To learn whether they were installed or not, see your `installActions.log` at `C:\program files\Oracle\Inventory\logs`.
- Oracle Enterprise Manager and its optional management packs have additional integrated tools to assist in managing databases. See *Oracle Enterprise Manager Concepts* for more information.
- Microsoft Management Console must be obtained from Microsoft Corporation for use with Windows NT 4.0.

## Preferred Database Tools

Table 3–1 lists various database tools you can use to perform common database administration tasks. Oracle recommends you use tools listed in the "Preferred Database Tool" column of the table. After choosing a tool to perform a task, go to Table 3–2, "Starting Database Tools from the Start Menu", on page 3-7 for instructions on how to start the tool.

---



---

**Note:** The VOLSIZE parameter for Export and Import utilities is not supported on Windows. If you attempt to use the utilities with the VOLSIZE parameter, then error LRM-00101 occurs. For example:

```
D:\> exp system/manager full=y volsize=100m;
LRM-00101: unknown parameter name 'volsize'
EXP-00019: failed to process parameters, type 'EXP HELP=Y' for
help
EXP-00000: Export terminated unsuccessfully
```

---



---

**Table 3–1 Preferred Database Tools**

Administration Task	Preferred Tool	Other Tools
Create a database	Database Configuration Assistant	SQL*Plus Worksheet
Delete database <a href="#">services</a>	Database Configuration Assistant	ORADIM
Start a database	Oracle Enterprise Manager Console	SQL*Plus or SQL*Plus Worksheet
Shut down a database	Oracle Enterprise Manager Console	Control Panel SQL*Plus or SQL*Plus Worksheet
Change database passwords	ORAPWD	ORADIM
Migrate database users to a directory	User Migration Utility	None
Migrate a database	Oracle Database Upgrade Assistant	Migration Utility (MIG)
Upgrade a database	Oracle Database Upgrade Assistant	Run provided scripts in SQL*Plus
Export data	Data Pump Export (EXPDP)	Export (EXP)
Import data	Data Pump Import (IMPDP)	Import (IMP)
Load data	Oracle Enterprise Manager Load Wizard	SQL*Loader (SQLLDR)

**Table 3–1 (Cont.) Preferred Database Tools**

<b>Administration Task</b>	<b>Preferred Tool</b>	<b>Other Tools</b>
Back up database	Oracle Enterprise Manager Backup Wizard	Recovery Manager (RMAN) OCOPY
Recover database	Oracle Enterprise Manager Recovery Wizard	Recovery Manager (RMAN) OCOPY
Authenticate database administrators and users	Oracle Enterprise Manager Console	SQL*Plus or SQL*Plus Worksheet Windows operating system Oracle Administration Assistant for Windows
Store encrypted and decrypted Oracle Wallet (Oracle Advanced Security and <a href="#">Oracle PKI</a> integration)	Oracle Wallet Manager	None
Grant database roles	Oracle Enterprise Manager Console	Local Users and Groups User Manager SQL*Plus
Create database objects	Oracle Enterprise Manager Console	SQL*Plus

---

**Note:** The following refer to items in Table 4-7.

- ORADIM can only set a password when none was previously set. If a password has been previously set, then ORADIM can change it only by deleting and re-creating Oracle Database services.
  - User Migration Utility can migrate local or external users to enterprise users. For more information, see "Using the User Migration Utility" in *Oracle Advanced Security Administrator's Guide*.
  - Oracle Database Upgrade Assistant can upgrade the following databases to the current release: Oracle7 release 7.3.4, Oracle8 release 8.0.6, Oracle8i releases 8.1.5, 8.1.6, and 8.1.7, Oracle9i releases 1 (9.0.1) and 2 (9.2). It cannot be used to upgrade an earlier Oracle7 release to a later Oracle7 release. See your Oracle7 for Windows NT documentation for information on how to upgrade from one Oracle7 database to another.
  - Data Pump Export and Data Pump Import are preferred for Oracle Database 10g data; Export and Import are preferred for earlier data.
  - When upgrading a database, the provided scripts in SQL\*Plus are required when upgrading Oracle Real Application Clusters systems.
  - If you back up files while you are shutting down the database, then your backup will be invalid. You cannot use an invalid backup to restore files at a later date.
  - For guidelines on creating database objects, see *Oracle Database Administrator's Guide*.
- 

## Starting Database Tools

This section describes how to start each of the database tools in the following categories:

- [Starting Database Tools in Multiple Oracle Homes](#)
- [Starting Database Tools from the Start Menu](#)
- [Starting Database Tools from the Command Line](#)

- [Starting Windows Tools](#)

You will be referred back to this section for database tool startup procedures as you use this guide.

## Starting Database Tools in Multiple Oracle Homes

If you have [multiple Oracle homes](#) on your computer from previous releases, then see [Chapter 2, "Multiple Oracle Homes and Optimal Flexible Architecture"](#) for a description of differences between Oracle homes before and after Oracle Database 10g.

### Starting Tools from Oracle8 Release 8.0.4 and Later 8.0.x Multiple Oracle Homes

If you are using multiple Oracle homes, then the command to start a tool from any home other than the first includes a *HOME\_NAME*, where *HOME\_NAME* indicates the name of that Oracle home. The *first* Oracle home created on your computer does not have *HOME\_NAME* appended to the group.

To start Oracle Administration Assistant for Windows from the first Oracle home, choose **Start > Programs > Oracle > Configuration and Migration Tools > Administration Assistant for Windows**.

To start Oracle Administration Assistant for Windows from an additional Oracle home, choose **Start > Programs > Oracle - *HOME\_NAME* > Configuration and Migration Tools > Administration Assistant for Windows**.

### Starting Tools from Oracle8i Release 8.1.3 and Later Multiple Oracle Homes

Beginning in Oracle8i release 8.1.3, each Oracle home, including the first Oracle home you create on your computer, has a unique *HOME\_NAME*. To start Oracle Administration Assistant for Windows from any Oracle home, choose **Start > Programs > Oracle - *HOME\_NAME* > Configuration and Migration Tools > Administration Assistant for Windows**.

## Starting Database Tools from the Start Menu

[Table 3–2](#) describes how to start assistants and other tools from the Start Menu. It also tells where to go for further information on using these products. All Start Menu paths begin with **Start > Programs > Oracle - *HOME\_NAME* >**.



---



---

**Note:** When you use an assistant, you must have read and write access to the directory where database files will be moved or created. To create an Oracle Database, you must have an administrative **privilege**. If you run Database Configuration Assistant from an account that is not part of the Administrators group, then the tool exits without completing the operation.

---



---



---



---

**Note:** All Start Menu paths begin with choose **Start > Programs > Oracle - HOME\_NAME >**.

---



---

**Table 3–2 Starting Database Tools from the Start Menu**

<b>Tool</b>	<b>Start Menu Path</b>	<b>More Information</b>
Oracle Administration Assistant for Windows	<b>Configuration and Migration Tools &gt; Administration Assistant for Windows</b>	<a href="#">Chapter 9, "Authenticating Database Users with Windows"</a>
Oracle Database Upgrade Assistant	<b>Configuration and Migration Tools &gt; Database Upgrade Assistant</b>	<i>Oracle Database Upgrade Guide</i>
Database Configuration Assistant	<b>Configuration and Migration Tools &gt; Database Configuration Assistant</b>	<a href="#">"Creating a Database on Windows Using Database Configuration Assistant"</a> on page 4-3
Oracle Enterprise Manager Configuration Assistant	<b>Configuration and Migration Tools &gt; Enterprise Manager Configuration Assistant</b>	<i>Oracle Enterprise Manager Grid Control Installation and Basic Configuration</i>
Oracle Enterprise Manager Console	<b>Enterprise Manager Console</b>	<i>Oracle 2 Day DBA</i>
Oracle INTYPE File Assistant	<b>Application Development &gt; INTYPE File Assistant</b>	Oracle INTYPE File Assistant online help
Oracle Locale Builder	<b>Configuration and Migration Tools &gt; Locale Builder</b>	<i>Oracle Database Globalization Support Guide</i>
Microsoft ODBC Administrator	<b>Configuration and Migration Tools &gt; Microsoft ODBC Administration</b>	Microsoft ODBC Administration online help

**Table 3–2 (Cont.) Starting Database Tools from the Start Menu**

<b>Tool</b>	<b>Start Menu Path</b>	<b>More Information</b>
Oracle Migration Workbench	<b>Configuration and Migration Tools &gt; Migration Workbench</b>	<i>Oracle Migration Workbench Release Notes</i> <i>Oracle Migration Workbench Reference Guide for Microsoft SQL Server and Sybase Adaptive Server Migrations</i> <i>Oracle Migration Workbench Reference Guide for Microsoft Access 2.0, 95, 97, 2000 Migrations</i>
Oracle Net Configuration Assistant	<b>Configuration and Migration Tools &gt; Net Configuration Assistant</b>	<i>Oracle Net Services Administrator's Guide</i>
Oracle Net Manager	<b>Configuration and Migration Tools &gt; Net Manager</b>	<i>Oracle Net Services Administrator's Guide</i>
Oracle Directory Manager	<b>Integrated Management Tools &gt; Oracle Directory Manager</b>	<i>Oracle Internet Directory Administrator's Guide</i>
Oracle Counters for Windows Performance Monitor	<b>Configuration and Migration Tools &gt; Oracle Counters for Windows Performance Monitor</b>	" <a href="#">Using Oracle Counters for Windows Performance Monitor</a> " on page 7-2
Pro*C/C++	<b>Application Development &gt; Pro*C/C++</b>	<i>Pro*C/C++ Programmer's Guide</i>
SQL*Plus	<b>Application Development &gt; SQL*Plus</b>	<i>SQL*Plus User's Guide and Reference</i> " <a href="#">Starting and Shutting Down a Database with SQL*Plus</a> " on page 6-8
SQL*Plus Worksheet	<b>Application Development &gt; SQL*Plus Worksheet</b> <b>Integrated Management Tools &gt; SQL*Plus Worksheet</b>	<i>Oracle Enterprise Manager Administrator's Guide</i>
Oracle Wallet Manager	<b>Integrated Management Tools &gt; Wallet Manager</b>	<i>Oracle Advanced Security Administrator's Guide</i>

## Starting Database Tools from the Command Line

Table 3–3 describes how to start Oracle Database tools from the command line, and where to go for further information on using these products.

**Table 3-3 Starting Database Tools from the Command Line**

<b>Tool</b>	<b>Enter at Prompt</b>	<b>More Information</b>
Oracle Enterprise Manager Console	C:\> oemapp console	<i>Oracle 2 Day DBA</i>
DBVERIFY	C:\> dbv  DBVERIFY starts and prompts you for a filename parameter. To obtain a list of parameters, enter:  C:\> dbv help=y	<i>Oracle Database Utilities</i>
Data Pump Export	C:\> expdp username/password  EXPDP starts and prompts you for parameters. To obtain a list of these parameters, enter:  C:\> expdp help=y	<i>Oracle Database Utilities</i> for instructions on use of Data Pump Export  <i>Oracle Database Error Messages</i> for information on error messages
Data Pump Import	C:\> impdp username/password  IMPDP starts and prompts you for parameters. To get a list of these parameters, enter:  C:\> impdp help=y	<i>Oracle Database Utilities</i> for instructions on use of Data Pump Import  <i>Oracle Database Error Messages</i> for information on error messages
Export	C:\> exp username/password  EXP starts and prompts you for parameters. To obtain a list of these parameters, enter:  C:\> exp help=y	<i>Oracle Database Utilities</i> for instructions on use of Export  <i>Oracle Database Error Messages</i> for information on error messages
Import	C:\> imp username/password  IMP starts and prompts you for parameters. To get a list of these parameters, enter:  C:\> imp help=y	<i>Oracle Database Utilities</i> for instructions on use of Import  <i>Oracle Database Error Messages</i> for information on error messages
Migration Utility	C:\> mig  To obtain a list of parameters, enter:  C:\> mig help=y	<i>Oracle Database Upgrade Guide</i>
OPERFCFGver	C:\> OPERFCFGver	<a href="#">"Modifying Oracle Counters for Windows Performance Monitor Parameters"</a> on page 14-19

**Table 3–3 (Cont.) Starting Database Tools from the Command Line**

<b>Tool</b>	<b>Enter at Prompt</b>	<b>More Information</b>
ORADIM	<pre>C:\&gt; oradim options</pre> <p>To get a list of ORADIM options, enter either of the following:</p> <pre>C:\&gt; oradim</pre> <pre>C:\&gt; oradim -?   -h   -help</pre>	"Using ORADIM to Administer an Oracle Database Instance" on page 4-18
Password Utility (ORAPWD)	<pre>C:\&gt; orapwd</pre> <p>Password file is hidden. Use Windows Explorer to see it in a file list. Choose View &gt; Options &gt; View &gt; Show All Files</p>	"Creating and Populating Password Files" on page 6-14
Recovery Manager (RMAN)	<pre>C:\&gt; rman parameters</pre>	<i>Oracle Database Backup and Recovery Basics</i>
SQL*Plus (SQLPLUS)	<pre>C:\&gt; sqlplus</pre>	<i>SQL*Plus User's Guide and Reference</i> "Starting and Shutting Down a Database with SQL*Plus" on page 6-8
SQL*Loader (SQLLDR)	<pre>C:\&gt; sqlldr</pre> <p>SQL*Loader displays a Help screen with available keywords and default values.</p>	<i>Oracle Database Utilities</i> <i>Oracle Database Error Messages</i> "Starting Windows Tools" on page 3-11
TKPROF	<pre>C:\&gt; tkprof</pre>	<i>Oracle Database Performance Tuning Guide</i>
User Migration Utility	<pre>C:\&gt; umu parameters</pre> <p>To get a list of parameters, enter:</p> <pre>C:\&gt; umu help=yes</pre>	"Using the User Migration Utility" in <i>Oracle Advanced Security Administrator's Guide</i>

---

**Note:** Three special conditions apply when running Export or Import utilities on Windows. First, default values for BUFFER and RECORDLENGTH parameters are 4 KB and 2 KB respectively. This default RECORDLENGTH parameter does not depend on the value of BUFSIZ defined in the system header file. If you specify a value larger than USHRT\_MAX (64 KB), you will get a warning message. Second, the VOLSIZE parameter is not supported. Third, to export an entire database, you must use the EXP\_FULL\_DATABASE role.

---

## Starting Windows Tools

Table 3–4 describes how to start each Windows tool and where to go for more information on using these products.

**Table 3–4 Starting Windows Tools**

Tool	Start Procedure	More Information
Event Viewer	Choose <b>Start &gt; Programs &gt; Administrative Tools &gt; Event Viewer</b>	"Using Event Viewer to Monitor a Database" on page 3-15 Your Windows documentation
Microsoft Management Console (MMC) <sup>1</sup>	Choose <b>Start &gt; Programs &gt; Oracle - HOME_NAME &gt; Configuration and Migration Tools &gt; Administration Assistant for Windows</b>	Your Windows documentation
Oracle Counters for Windows Performance Monitor	Choose <b>Start &gt; Programs &gt; Oracle - HOME_NAME &gt; Configuration and Migration Tools &gt; Oracle Counters for Windows Performance Monitor</b>	"Using Oracle Counters for Windows Performance Monitor" on page 7-2 Your Windows documentation
Registry Editor	At the command prompt enter: <code>C:\&gt; regedt32</code>	"Using Registry Editor to Modify Configuration Information" on page 3-17 Chapter 14, "Configuration Parameters and the Registry" Your Windows documentation
Task Manager	Right-click the Task Bar and choose <b>Task Manager</b>	"Using Task Manager to Monitor Applications and Processes" on page 3-17 Your Windows documentation
Local Users and Groups	Choose <b>Start &gt; Settings &gt; Control Panel</b> . Double-click <b>Administrative Tools</b> . Double-click <b>Computer Management</b> . In the console tree, click <b>Local Users and Groups</b> .	"Using Local Users and Groups to Manage Users and Groups" on page 3-18 Your Windows documentation
User Manager	Choose <b>Start &gt; Programs &gt; Administrative Tools &gt; User Manager</b>	"Using User Manager to Manage Users" on page 3-18 Chapter 9, "Authenticating Database Users with Windows" Your Windows documentation

<sup>1</sup> MMC is started whenever Oracle Administration Assistant for Windows is started.

## Using SQL\*Loader

This section describes Windows-specific information for using SQL\*Loader (SQLLDR).

### Windows Processing Options

This section discusses possible values for the Operating System Dependent (OSD) file processing specifications string option, referred to in "SQL\*Loader Control File Reference" in *Oracle Database Utilities*.

#### Default (No Processing Option) or "str terminator\_string"

Stream record format in which each record is terminated by a record terminator. If "str terminator\_string" is not specified, then the record terminator defaults to either the Windows-style record terminator (the two-character sequence carriage return, \r, followed by line feed, \n) or the UNIX-style record terminator (single-character line feed, \n). Maximum record size is 48 KB.

When processing stream format data files, SQL\*Loader can usually recognize record terminators automatically, whether they are Windows-style or UNIX-style. So you usually do not need to specify which record terminator you are using.

For external table loads, however, only Windows-style record terminators are recognized automatically. If your data file contains UNIX-style record terminators, you must specify the record terminator. If you are using SQL\*Loader (with `external_table` option), then specify the UNIX-style record terminator by specifying "str '\n'" on the INFILE line in the SQL\*Loader control file. For example:

```
INFILE mydata.dat "str '\n'"
```

You can also specify the record terminator in hex, by specifying "str x'0a'" (assuming an ASCII-based character set). For example:

```
INFILE mydata.dat "str x'0a'"
```

Note that the "0" (zero) before the "a" is required. If you are using SQL with an access parameter list to create the external table, then you must specify '\n' in a RECORDS DELIMITED BY clause. For example:

```
RECORDS DELIMITED BY '\n'
```

You can also use a hex string in this case. For example:

```
RECORDS DELIMITED BY 0x'0a'
```

Note that in this case, the "0" (zero) before the "x" and the "0" (zero) before the "a" are both required.

### "FIX *n*"

Fixed record format in which each record is exactly *n* bytes long. Record terminators are not required with fixed record format. If the record includes a record terminator, then the record terminator bytes are included in the number of bytes *n*.

### "VAR *n*"

Variable record format in which the length of each record in a character field is included at the beginning of each record in the datafile. Record terminators are not required with the variable record format. This format provides some added flexibility over the fixed record format and a performance advantage over the stream record format. You can specify a datafile that is to be interpreted as being in variable record format as follows:

```
INFILE "mydata.dat" "var n"
```

In this example, *n* specifies the number of bytes in the record length field. If *n* is not specified, SQL\*Loader assumes a length of 5 bytes. Specifying *n* larger than 40 will result in an error. Lengths are always interpreted in bytes, even if character-length semantics are in effect for the file. This is necessary because the file could contain a mix of fields, some processed with character-length semantics and others processed with byte-length semantics.

## Case Study Files

The distribution media for SQL\*Loader contains case study files for **control files**, **datafiles**, and **setup files** in `ulcase1, . . . ulcase11` in the following directory:  
`Oracle_Home\rdbms\demo.`

## Specifying the Bad File

When SQL\*Loader executes, it can create a file called a bad file or reject file in which it places records that were rejected because of formatting errors or because they caused Oracle Database errors. If you have specified that a bad file is to be created, it overwrites any existing file with the same name; ensure that you do not overwrite a file you wish to retain.

## Control File Conventions

When preparing SQL\*Loader control files (.ctl), you must follow certain syntax and notational conventions.

In full path descriptions, backslashes do not require escape characters or other special treatment. When embedding a single or double quotation mark inside a string delimited by double quotation marks, place a backslash escape character before the embedded quotation mark.

When specifying datatypes in the SQL\*Loader control file, note that the default sizes of native datatypes shown in [Table 3-5](#) are specific to Windows. These datatypes can be loaded with correct results only between systems where they have the same length in bytes. You cannot override these defaults in the control file. If the byte order is different between the systems, you can indicate the byte order of the data with the `BYTEORDER` parameter, or you can place a byte-order mark (BOM) in the file.

**Table 3-5** *Default Sizes of Native Datatypes*

Native Datatypes	Default Field Length
DOUBLE	8
FLOAT	4
INTEGER <sup>1</sup>	4
SMALLINT	2

<sup>1</sup> The default listed is correct if `INTEGER` is specified without a size. But `INTEGER(n)` is also allowed. In that case, `n` specifies the size of the `INTEGER` field in bytes.

**See Also:** *Oracle Database Utilities* for a complete list of options and instructions on using SQL\*Loader



## Using Windows Tools

You can use Windows tools in various ways to manage Oracle Database:

- [Using Event Viewer to Monitor a Database](#)
- [Using Microsoft Management Console to Administer a Database](#)
- [Using Oracle Counters for Windows Performance Monitor](#)
- [Using Registry Editor to Modify Configuration Information](#)
- [Using Task Manager to Monitor Applications and Processes](#)
- [Using Local Users and Groups to Manage Users and Groups](#)
- [Using User Manager to Manage Users](#)

### Using Event Viewer to Monitor a Database

Event Viewer lets you monitor events in your system. An event is an important occurrence in the system or application (such as Oracle Database) that requires user notification. While messages for major events can appear on-screen as you work at your computer, events not requiring your immediate attention are recorded by Windows in the Event Viewer log file. You can then view this information at your convenience.

Event Viewer can be used to monitor Oracle Database events, such as:

- Initialization of **System Global Area** for active **instance**
- Initialization of Program Global Area (PGA) for background processes of active instance
- Connection to Oracle Database using AS SYSDBA

In addition, the operating system audit trail is logged to Event Viewer.

**See Also:** [Chapter 7, "Monitoring a Database on Windows"](#) for specific instructions on accessing and using Event Viewer to monitor Oracle Database events

### Using Microsoft Management Console to Administer a Database

Microsoft Management Console provides a central location for network administration. Microsoft Management Console hosts applications (called **snap-ins**) that administrators can use to manage their networks. Oracle snap-ins enable database administrators to:

- Configure Oracle Database administrators, operators, users, and roles so the Windows operating system can **authenticate** them
- Configure OracleServiceSID
- Modify **registry** parameters for all Oracle homes on the computer
- Modify the computer hostname, **username**, and password for the database being monitored by Oracle Counters for Windows Performance Monitor
- View and terminate an Oracle Database **thread**

## Using Oracle Counters for Windows Performance Monitor

Oracle Counters for Windows Performance Monitor is integrated into Windows Performance Monitor. This tool enables you to view performance of processors, memory, cache, threads, and processes. Performance information provided includes device usage, queue lengths, delays, throughput measurements, and internal congestion measurements. This information is provided as charts, alerts, and reports.

You can use Oracle Counters for Windows Performance Monitor to monitor key Oracle Database information, such as:

- Library cache
- Buffer cache
- Data dictionary cache
- Redo log buffer cache
- Thread activity

You can use your findings to improve database performance.

**See Also:** ["Using Oracle Counters for Windows Performance Monitor"](#) on page 7-2 for specific instructions on accessing and using Oracle Counters for Windows Performance Monitor to monitor Oracle Database performance

## Using Registry Editor to Modify Configuration Information

Oracle Database stores its configuration information in a structure known as the registry. You can view and modify this configuration information through Registry Editor. The registry contains configuration information for your computer and must not be accessible for editing by inexperienced users. Only experienced administrators should view and change this information.

Registry Editor displays configuration information in a format similar to Windows Explorer. In the left-hand window is a tree-like format consisting of keys (or folders). When one of these keys is highlighted, parameters and values assigned to that key are displayed in the right-hand window.

When you install products from your CD-ROM, configuration parameters are automatically entered in the registry. These parameters are read each time your Windows computer is started and whenever an Oracle Database product is started. These parameters include settings for:

- Oracle home directory
- Language
- Company name
- Oracle home subdirectories for individual products
- Individual products such as SQL\*Plus
- Services

**See Also:** [Chapter 14, "Configuration Parameters and the Registry"](#) for definitions of Oracle Database configuration parameters and specific instructions on using the registry to modify Oracle Database configuration parameters

## Using Task Manager to Monitor Applications and Processes

Task Manager has three tabs:

- Applications tab displays what applications are running. This is useful for identifying and ending unresponsive tasks. (Oracle Database does not appear as an application because it runs as a service.)
- Processes tab displays details of currently running processes and their resource usage. Columns are customizable.

- Performance tab graphically displays real-time CPU and memory usage, which is useful for spotting sudden changes.

## Using Local Users and Groups to Manage Users and Groups

Local Users and Groups enables you to manage users and groups on Windows 2000 and Windows XP. Specifically, you can:

- Create and modify local user accounts
- Create and modify user profiles
- Create, add, and delete local groups

## Using User Manager to Manage Users

User Manager enables you to manage Windows computer security and create user accounts on Windows NT. With User Manager, you can:

- Grant Oracle Database roles
- Use operating system authentication for user accounts (For example, you can grant DBA access to a Windows user.)
- Create a Windows user account that enables you to make secure client connections to Oracle Database without a password

**See Also:** ["Manually Administering External Users and Roles"](#) on page 10-38 for specific instructions on using User Manager to perform Oracle Database administration

## Optional Windows Diagnostic and Tuning Utilities

Windows 2000 Resource Kit includes several diagnostic and tuning utilities.

QuickSlice provides a quick overview of what is occurring on the system, using a graphical user interface.

- Distinguishes between time spent in user mode and kernel mode
- Imposes low overhead on the system (unlike Performance Monitor)
- Shows a continuous display, rather than just a **snapshot**
- Opens a window with more details when you double-click a **process**

Process Viewer summarizes resource usage by a process.

Process Explode provides a detailed display of resource usage by a process.

Task List displays resource usage and other details of a process when its processor identifier or process name is given as an argument. This tool also displays a list of executables and DLLs associated with a process.

**See Also:**

- [Appendix E, "Using Oracle Database on Windows 2000"](#)
- [Chapter 6, "Administering a Database on Windows"](#) for OracleServiceSID configuration tasks
- [Chapter 7, "Monitoring a Database on Windows"](#) for thread management tasks
- [Chapter 9, "Authenticating Database Users with Windows"](#) for authentication tasks
- [Chapter 14, "Configuration Parameters and the Registry"](#) and [Chapter 7, "Monitoring a Database on Windows"](#) for Oracle Counters for Windows Performance Monitor tasks
- *Oracle Database Installation Guide for Windows* for components available for installation



---

---

# Postinstallation Database Creation on Windows

This chapter describes how to create a database after installing Oracle Database, using either Database Configuration Assistant or command-line tools.

This chapter contains these topics:

- [Naming Conventions for Oracle Database](#)
- [Accessing Data Files and Log Files on Remote Computers](#)
- [Creating a Database on Windows Using Database Configuration Assistant](#)
- [Creating a Database on Windows Using Command-Line Tools](#)
- [Using ORADIM to Administer an Oracle Database Instance](#)

## Naming Conventions for Oracle Database

All mounted instances of Oracle Database in a network must have unique database names. When a database is created, a name is associated with it and stored in its **control files**. If you provide the database keyword, either in the `CREATE DATABASE` statement or when prompted by Database Configuration Assistant, then that value becomes the name for that database.

If you attempt to **mount** two instances of Oracle Database with the same database name, then you receive the following error during mounting of the second database:

```
ORA-01102: cannot mount database in EXCLUSIVE mode
```

If there are two or more instances of Oracle Database on the same computer, but located in different Oracle homes, then the following rules apply:

- Each database name must be unique
- Each **SID** must be unique

To change the name of an existing database, you must use the `CREATE CONTROLFILE` statement to re-create your control files and specify a new database name. This restriction exists only for Oracle8i and later versions. Any Oracle7 release 7 instances running simultaneously with an Oracle Database 10g **instance** are not subject to this restriction.

---



---

**Note:** Directory path examples in this chapter follow **Optimal Flexible Architecture** (OFA) guidelines. An example of an OFA path is `ORACLE_BASE\ORACLE_HOME\rdms\admin`. If you specified non-OFA directories during installation, then your directory paths will differ.

---



---

## Accessing Data Files and Log Files on Remote Computers

Oracle Database can access database files on a **remote computer** using Universal Naming Convention (UNC), but it may degrade database performance and network reliability. UNC is a PC format for specifying locations of resources on a local area network. UNC uses the following format:

```
\\server-name\shared-resource-path-name
```



For example, UNC specification for file `system01.dbf` in directory `C:\oracle\oradata\orcl` on shared server `argon` would be:

```
\\argon\oracle\oradata\orcl\system01.dbf
```

Locations of archive log files cannot be specified using UNC. Always set initialization parameter `LOG_ARCHIVE_DEST_n` to a mapped drive. If you set it to a UNC specification, then Oracle Database does not start and you receive the following errors:

```
ORA-00256: error occurred in translating archive text string '\meldell\rmdrive'  
ORA-09291: sksachk: invalid device specified for archive destination  
OSD-04018: Unable to access the specified directory or device  
O/S-Error: (OS 2) The system cannot find the file specified
```

An ORA-00256 error also occurs if you enter `\\meldell\rmdrive` or `\\meldell\rmdrive`. Control files required the additional backslashes for Oracle8 release 8.0.4, but **redo log files** and datafiles did not.

## Creating a Database on Windows Using Database Configuration Assistant

Oracle recommends you use Database Configuration Assistant to create a database, because it is easier. It offers the same interface and operates the same way on all supported platforms, so no step-by-step procedures or screen shots are included here.

**See Also:** *Oracle 2 Day DBA* for instructions on using Database Configuration Assistant

Database Configuration Assistant enables you to:

- Create a Database
- Configure Database Options in a database
- Delete a Database
- Manage Templates

An **initialization parameter file** is an ASCII text file containing parameters. It can be used to create and modify a database using command-line tools. When you create a database using Database Configuration Assistant, a server parameter file (SPFILE) is created from the initialization parameter file, and the initialization

parameter file is renamed. Oracle does not recognize the renamed file as an initialization parameter file, and it is not used after the instance is started.

If you want to modify an instance created with Database Configuration Assistant after it starts up, you must use `ALTER SYSTEM` statements. You cannot change the SPFILE itself, because it is a binary file that cannot be browsed or edited using a text editor. The location of the newly-created SPFILE is `ORACLE_BASE\ORACLE_HOME\database`. The SPFILE filename is `spfileSID.ora`.

**See Also:** "Managing Initialization Parameters Using a Server Parameter File" in *Oracle Database Administrator's Guide*

## Creating a Database on Windows Using Command-Line Tools

This section describes how to create a new database manually. As part of its database software files, Oracle Database provides a sample database creation script and a sample initialization parameter file, both of which can be edited to suit your needs. Alternatively, if you have an existing script you can use it as-is to create a database manually or edit it using the sample database creation script as a guide.

Database creations are of three types:

- Copy an existing database and delete the old database.
- Copy an existing database and keep the old database.
- Create a new database when no database exists on your system.

[Table 4–1](#) summarizes tasks involved in creating a new database for each of these database creation categories. Each step is explained in detail in the following subsections.

**Table 4–1 Manual Database Creation Tasks**

Task	Copy existing database and delete old database	Copy existing database and keep old database	Create new database when no database exists on system
<a href="#">Creating Directories</a>	Yes	Yes	Yes
<a href="#">Exporting an Existing Database</a>	Yes	Maybe <sup>1</sup>	Not applicable
<a href="#">Deleting Database Files</a>	Yes	No	Not applicable
<a href="#">Modifying the Initialization Parameter File</a>	Yes	Yes	Yes

**Table 4–1 (Cont.) Manual Database Creation Tasks**

Task	Copy existing database and delete old database	Copy existing database and keep old database	Create new database when no database exists on system
Starting an Oracle Database Instance	Yes	Yes	Yes
Creating and Starting an Oracle Database Service	No	Yes	Yes
Putting the CREATE DATABASE Statement in a Script	Yes	Yes	Yes
Running the CREATE DATABASE Script	Yes	Yes	Yes
Importing a Database	Yes	Maybe <sup>2</sup>	Not applicable
Updating ORACLE_SID in the Registry	No	Only if you change the default SID	Yes
Backing Up the New Database	Yes	Yes	Yes

<sup>1</sup> Yes if you copy data from the existing database to the new database; no otherwise.

<sup>2</sup> Yes if you import tables and other objects exported from the existing database; no otherwise.

We use an example in the following sections to demonstrate how to create a database. In this example, the existing database is the **starter database** with a SID of `orcl` located in directory `C:\oracle\oradata\orcl`. You will copy `orcl` to a new database with a database name and SID of `prod` located in directory `C:\oracle\oradata\prod`. You will then delete starter database `orcl`.

---



---

**Note:** In this example, `ORACLE_BASE` is `C:\oracle`. See "[Conventions](#)" on page xxi for more information on `ORACLE_BASE`.

---



---

## Creating Directories

Create the following directories in which to put administration and database files for new database `prod`:

- `C:\oracle\admin\prod`
- `C:\oracle\admin\prod\bdump`

- C:\oracle\admin\prod\pfile
- C:\oracle\admin\prod\udump
- C:\oracle\oradata\prod

## Exporting an Existing Database

You are required to export an existing database only if you intend to copy its contents to a new database. If you are working with data from an earlier Oracle release, then you can use Export for this task. If you are using Oracle Database 10g data, then Oracle recommends that you use Data Pump Export because it supports new Oracle Database 10g features, such as floating points.

Although you can start Data Pump Export or Export in either parameter mode or interactive mode, Oracle recommends parameter mode. Interactive mode provides less functionality than parameter mode and exists for backward compatibility only.

The syntax for Data Pump Export parameter mode is:

```
C:\> expdp SYSTEM/password DUMPFILE=myexp.dmp FULL=y LOGFILE=myexp.log
```

The syntax for Data Pump Export interactive mode is:

```
C:\> expdp SYSTEM/password
```

Enter only the command `expdp SYSTEM/password` to begin an interactive session and let Data Pump Export prompt you for information it needs.

---

---

**Note:** If you use parameter mode, then Data Pump Export considers filenames and directory names to be invalid if they contain one or more blank spaces. The workaround is to enclose the full path in the `DUMPFILE=` parameter in triple quotation marks. For example:

```
DUMPFILE=" "C:\program files\export.dmp" "
```

If Data Pump Export is used in interactive mode, then the filename or directory name can contain a space without quotation marks.

---

---

The syntax for Export parameter mode is:

```
C:\> exp SYSTEM/password FILE=myexp.dmp FULL=y LOG=myexp.log
```

The syntax for Export interactive mode is:

```
C:\> exp SYSTEM/password
```

Enter only the command `exp SYSTEM/password` to begin an interactive session and let Export prompt you for information it needs.

---

---

**Note:** If you use parameter mode, then Export considers filenames and directory names to be invalid if they contain one or more blank spaces. The workaround is to enclose the full path in the `FILE=` parameter in triple quotation marks. For example:

```
FILE=" "C:\program files\export.dmp" " "
```

If Export is used in interactive mode, then the filename or directory name can contain a space without quotation marks.

---

---

**See Also:** *Oracle Database Utilities* for more information on using Data Pump Export or Export

To export all data from an existing database to a new database:

1. Set `ORACLE_SID` to the database service of the database whose contents you intend to export. For example, if the database you intend to export is starter database `orcl`, then enter the following at the command prompt. Note that there are no spaces around the equal sign (=) character.

```
C:\> set ORACLE_SID=orcl
```

2. If the existing database is Oracle Database 10g, then start Data Pump Export from the command prompt:

```
C:\> expdp SYSTEM/password DUMPFILE=myexp.dmp FULL=y LOG=myexp.log
```

You now have a full database export of starter database `orcl` in file `myexp.dmp`. All messages from Data Pump Export are logged in file `myexp.log`.

3. If the existing database is before Oracle Database 10g, then start Export from the command prompt:

```
C:\> exp SYSTEM/password FILE=myexp.dmp FULL=y LOG=myexp.log
```

You now have a full database export of starter database `orcl` in file `myexp.dmp`. All messages from Export are logged in file `myexp.log`.

## Deleting Database Files

Deleting database files is required only when you copy an existing database to a new database to replace the old database. In the following example, you delete the database files of starter database `orcl`.

To delete database files:

1. Shut down starter database `orcl` at the command prompt:

```
C:\> oradim -SHUTDOWN -SID orcl -SHUTTYPE inst -SHUTMODE immediate
```

2. Delete the following files from directory `C:\oracle\oradata\orcl`:

File Name	File Name	File Name	File Name
<code>control01.ctl</code>	<code>drsys01.dbf</code>	<code>temp01.dbf</code>	<code>xdb01.dbf</code>
<code>control02.ctl</code>	<code>cwmlite01.dbf</code>	<code>tools01.dbf</code>	<code>redo01.log</code>
<code>control03.ctl</code>	<code>example01.dbf</code>	<code>undotbs01.dbf</code>	<code>redo02.log</code>
<code>index01.dbf</code>	<code>system01.dbf</code>	<code>user01.dbf</code>	<code>redo03.log</code>

## Modifying the Initialization Parameter File

To use starter database `orcl` as the basis for your new database, first copy `ORACLE_BASE\admin\orcl\pfile\init.ora`. Second, put the copy in `ORACLE_BASE\admin\prod\pfile\init.ora`. Third, modify the file as described in this section.

---

---

**Note:** Beginning with Oracle9i release 2 (9.2), nesting of quotation marks using the backslash (\) escape character is no longer supported. This may affect how Oracle Database interprets parameter values in your initialization parameter file. For example, if you specified `CONTROL_FILES = "ctlfile\1.ora"` in releases prior to release 9.2, the filename would be interpreted as `ctlfile'1.ora`. Starting with release 9.2, the filename would be interpreted as `ctlfile\1.ora`.

Oracle highly recommends modifying your parameter files to remove such references. See *Oracle Database Reference* for other methods of nesting quotation marks in initialization parameter values.

---

---

If you do not have an existing database on your system, then you cannot copy an existing initialization parameter file to use as the basis for your new initialization parameter file. However, you can use the sample initialization parameter file `initsmpl.ora` provided in

```
ORACLE_BASE\ORACLE_HOME\admin\sample\pfile
```

as the basis for the initialization parameter file for database `prod`.

If you use `initsmpl.ora` as the basis for the initialization parameter file, then you must set the following parameters to the indicated values, or you will not be able to start database `prod`:

- `DB_NAME=prod.domain`

Parameter `DB_NAME` indicates the database name and must match the name used in the `CREATE DATABASE` statement in "[Putting the CREATE DATABASE Statement in a Script](#)" on page 4-11. You give a unique database name to each database. You can use up to eight characters for a database name. The name is not required to match the SID of the database service.

- `INSTANCE_NAME=prod.domain`
- `SERVICE_NAMES=prod.domain`
- `CONTROL_FILES = ("C:\oracle\oradata\prod\control01.ctl",  
"C:\oracle\oradata\prod\control02.ctl",  
"C:\oracle\oradata\prod\control03.ctl")`

Parameter `CONTROL_FILES` lists database control files. You do not have control files on your file system at this point, because control files are created when you run the `CREATE DATABASE` statement. Ensure that you specify the complete path and filename, including drive letter.

- `BACKGROUND_DUMP_DEST = C:\oracle\admin\prod\bdump`
- `USER_DUMP_DEST = C:\oracle\admin\prod\udump`
- `DB_FILES=100`

Modifying initialization parameter `DB_FILES` is not required, but it is recommended to optimize performance. Set this parameter to the same number as the value of the `MAXDATAFILES` option of the `CREATE DATABASE` statement. The value of 100 is used for this example.

**See Also:** *Oracle Database Reference* for information on other initialization parameters that you can add or modify

## Starting an Oracle Database Instance

Start an instance without mounting a database.

```
STARTUP NOMOUNT
```

You are not required to specify the `PFFILE` clause in this example, because the initialization parameter file is stored in the default location. At this point, there is no database. Only the SGA is created and background processes are started in preparation for the creation of a new database.

## Creating and Starting an Oracle Database Service

You are required to create and start an Oracle Database service only if you do one of the following:

- Copy an existing database to a new database and keep the old database
- Create a new database when you have no other database to copy

Before you create the database, first create a Windows service to run the database. This service is the Oracle Database **process**, `oracle.exe`, installed in the form of a Windows service.

Use ORADIM to create the service. After it has been created, the service starts automatically. See "[Using ORADIM to Administer an Oracle Database Instance](#)" on page 4-18 for information on how to use ORADIM.



To create and start an Oracle Database service:

1. Run ORADIM from the command prompt:

```
C:\> oradim -NEW -SID prod -STARTMODE manual  
-PFILE "C:\oracle\admin\prod\pfile\init.ora"
```

Note that the previously created initialization parameter file is specified, with complete path, including drive name. You can check if the service is started in the Services window of the Control Panel.

2. Set ORACLE\_SID to equal prod. Note that there are no spaces around the equal sign (=) character:

```
C:\> set ORACLE_SID=prod
```

## Putting the CREATE DATABASE Statement in a Script

The CREATE DATABASE statement is a SQL statement that creates the database. A script containing this statement can be used anytime you create a database.

The CREATE DATABASE statement may have the following parameters:

- MAXDATAFILES - default value: 32, maximum value: 65534
- MAXLOGFILES - default value: 32, maximum value: 255

When you run a CREATE DATABASE statement, Oracle Database performs several operations depending upon clauses that you specified in the CREATE DATABASE statement or initialization parameters that you have set.

---

---

**Note:** Oracle-managed files is a feature that works with the CREATE DATABASE statement to simplify administration of Oracle Database. Oracle-managed files eliminates the requirement to directly manage operating system files comprising an instance of Oracle Database, because you specify operations in terms of database objects rather than filenames. For more information on using Oracle-managed files see *Oracle Database Administrator's Guide*.

---

---

To create database prod, copy and save the following statement in a file named *script\_name.sql*:

```
CREATE DATABASE prod  
MAXLOGFILES 5  
MAXDATAFILES 100
```

```
DATAFILE 'oracle\oradata\prod\system01.dbf' SIZE 325M REUSE
AUTOEXTEND ON NEXT 10240K MAXSIZE UNLIMITED
UNDO TABLESPACE "UNDOTBS" DATAFILE 'oracle\oradata\prod\undotbs01.dbf'
SIZE 200M REUSE AUTOEXTEND ON NEXT 5120K MAXSIZE UNLIMITED
CHARACTER SET WE8MSWIN1252
logfile 'C:\oracle\oradata\prod\redo01.log' size 100M reuse,
        'C:\oracle\oradata\prod\redo02.log' size 100M reuse,
        'C:\oracle\oradata\prod\redo03.log' size 100M reuse;
```

### Running the CREATE DATABASE Script

To use the SQL script to create a database:

1. Verify that the service is started in the Control Panel. In this example, the service name is OracleServicePROD, and its status column must display Started. If not, then select the service name and choose Start.

You can also check the status of the service by entering the following at the command prompt:

```
C:\> net START
```

A list of all Windows services currently running on the system appears. If OracleServicePROD is missing from the list, then enter:

```
C:\> net START OracleServicePROD
```

2. Make PROD the current SID:

```
C:\> set ORACLE_SID=PROD
```

3. Start SQL\*Plus from the command prompt, and connect to the database as **SYSDBA**:

```
C:\> sqlplus /NOLOG
SQL> CONNECT / AS SYSDBA
```

The message `connected` appears.

4. Turn on spooling to save messages:

```
SQL> SPOOL script_name.log
```

5. Run script `script_name.sql` that you created in "Putting the CREATE DATABASE Statement in a Script" on page 4-11:

```
SQL> @C:\oracle\ora92\rdbms\admin\script_name.sql;
```

If the database is successfully created, then the instance is started and the following message appears numerous times: Statement processed

## Importing a Database

You can use Data Pump Import (for Oracle Database 10g data) or Import (for earlier data) to import the full export created in "Exporting an Existing Database" on page 4-6 into the new database. Although you can start Data Pump Import or Import using either parameter mode or interactive mode, Oracle recommends parameter mode because it provides more functionality. Interactive mode exists solely for backward compatibility.

The syntax for Data Pump Import parameter mode is:

```
C:\> impdp SYSTEM/password DUMPFILE=myexp.dmp FULL=y LOG=myexp.log
```

The syntax for Data Pump Import interactive mode is:

```
C:\> impdp SYSTEM/password
```

Enter only `impdp SYSTEM/password` to begin an interactive session and let Data Pump Import prompt you for information it needs.

---

---

**Note:** If you use parameter mode, then Data Pump Import considers filenames and directory names to be invalid if they contain one or more blank spaces. The workaround is to enclose the full path in the `DUMPFILE=` parameter in triple quotation marks. For example:

```
DUMPFILE=" "C:\program files\export.dmp" " "
```

If you use Data Pump Import in interactive mode, then the filename or directory name can contain a space without quotation marks.

---

---

The syntax for Import parameter mode is:

```
C:\> imp SYSTEM/password FILE=myexp.dmp FULL=y LOG=myexp.log
```

The syntax for Import interactive mode is:

```
C:\> imp SYSTEM/password
```

Enter only `imp SYSTEM/password` to begin an interactive session and let Import prompt you for information it needs.

---

---

**Note:** If you use parameter mode, then Import considers filenames and directory names to be invalid if they contain one or more blank spaces. The workaround is to enclose the full path in the `FILE=` parameter in triple quotation marks. For example:

```
FILE=" "C:\program files\export.dmp" " "
```

If you use Import in interactive mode, then the filename or directory name can contain a space without quotation marks.

---

---

---

---

**Note:** If the original database from which the export file was generated contains a **tablespace** that is not in the new database, then Import tries to create that tablespace with associated datafiles.

The easy solution is to ensure that both databases contain the same tablespaces. Datafiles are not required to be identical. Only tablespace names are important.

---

---

**See Also:** *Oracle Database Utilities* for more information on using Data Pump Import or Import

## Updating ORACLE\_SID in the Registry

If this is the first database on the system or if you intend to make the new database the default database, then you must make a change in the **registry**.

1. Start Registry Editor at the command prompt:

```
C:\> regedt32
```

The Registry Editor window appears.

2. Choose subkey `\HKEY_LOCAL_MACHINE\SOFTWARE\ORACLE\HOME0` for the first Oracle home on your computer. For subsequent installations to different Oracle homes on the same computer, the path is `\HKEY_LOCAL_MACHINE\SOFTWARE\ORACLE\HOMEID` where ID is the unique number identifying the Oracle home.

**See Also:** [Chapter 14, "Configuration Parameters and the Registry"](#) for more information on subkey locations for **multiple Oracle homes**

3. Locate parameter `ORACLE_SID` on the right side of the Registry Editor window.
4. Double-click the parameter name and change the data to the new SID, which is `prod` in this example.

If you do not yet have parameter `ORACLE_SID`, because this is the first database on your system, then you must create it.

To create parameter `ORACLE_SID`:

1. Choose **Add Value** from the **Edit** menu.

The Add Value dialog appears:

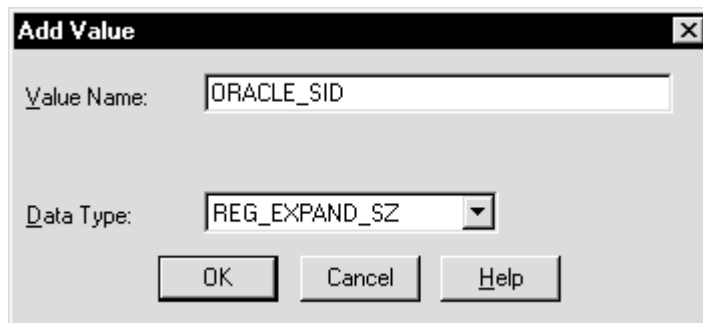

2. Enter `ORACLE_SID` in the **Value Name** field.
3. Select `REG_EXPAND_SZ` (for an expandable string) in the **Data Type** list.
4. Click **OK**.

A string editor dialog appropriate for the data type appears:

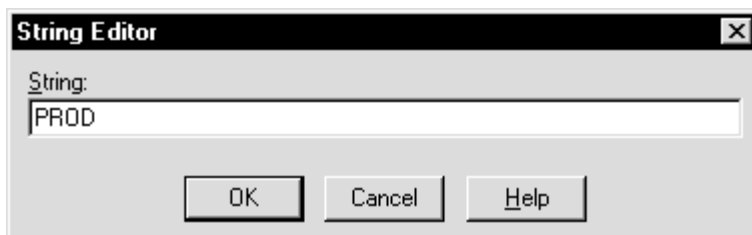

5. Enter **prod** in the **String** field.
6. Click **OK**.  
Registry Editor adds parameter ORACLE\_SID.
7. Choose **Exit** from the **Registry** menu.  
Registry Editor exits.

## Backing Up the New Database

---

---

**Caution:** If anything goes wrong while operating the new database without a **backup**, then you must repeat the database creation procedure. Back up your database now to prevent loss of data.

---

---

To back up the new database:

1. Shut down the database instance and stop the service:

```
C:\> oradim -SHUTDOWN -SID prod -SHUTTYPE srvc,inst -SHUTMODE immediate
```

---

---

**Caution:** Although ORADIM returns the prompt immediately, you must wait for the database and the service to stop completely before continuing to Step 2. Wait until the Control Panel indicates service OracleServicePROD has stopped. If you do not do this, then the backup may be useless because it was taken while data was being written to datafiles.

---

---

## 2. Using the tool of your choice, back up database files.

Database files consist of the initialization parameter file, control files, online redo log files, and datafiles.

When the backup is complete, you can start the database again, create users and objects, if necessary, make any other changes, and use the database.

Be sure to back up the database after making any significant changes, such as switching archiving mode or adding a tablespace or datafile.

**See Also:** For more information on archiving, backup, and [recovery](#)

- *Oracle Database Concepts*
- *Oracle Database Backup and Recovery Basics*
- *Oracle 2 Day DBA*

---

---

**Caution:** Do not store database files on a compressed drive. This can result in write errors and decreased performance.

---

---

## Using ORADIM to Administer an Oracle Database Instance

ORADIM is a command-line tool that is available with Oracle Database. You are required to use ORADIM only if you are manually creating, deleting, or modifying databases. Database Configuration Assistant is an easier tool to use for this purpose.

The following sections describe ORADIM commands and parameters. Note that each command is preceded by a dash (-). To get a list of ORADIM parameters, enter:

```
oradim -? | -h | -help
```

---

---

**Note:** Specifying `oradim` without any options also returns a list of ORADIM parameters and descriptions.

---

---

When you use ORADIM, a log file called `oradim.log` opens in `ORACLE_BASE\ORACLE_HOME\database`, or in the directory specified by registry parameter `ORA_CWD`. All operations, whether successful or failed, are logged in this file. You must check this file to verify success of an operation.

If you have installed an Oracle Database service on Windows 2000, then when logging in as SYSTEM user (LocalSystem), with startup mode set to Automatic, it is possible that the Oracle Database service starts but the database does not start automatically. The following error message is written to file `ORADIM.LOG` in directory `ORACLE_BASE\ORACLE_HOME\database`:

```
ORA-12640: Authentication adapter initialization failed
```

Oracle Enterprise Management Agent, Oracle Enterprise Manager Management Server and Oracle Internet Directory may also fail, because they cannot connect to the database for the same reason. The workarounds are:

- Modify `SQLNET.ORA`

You can modify `SQLNET.ORA`, either by removing the line

```
sqlnet.authentication_services=(NTS)
```

or by changing it to

```
sqlnet.authentication_services=(NONE)
```

- Start the database after the service starts

You can start the database manually after the Oracle Database service has started, using SQL\*Plus and connecting as `SYSDBA`.

- Start the service as a specific user

**See Also:** Your Windows documentation for instructions on starting services

## Creating an Instance

To use ORADIM to create an instance, enter:

```
oradim -NEW -SID SID | -SRVC service_name | -ASMSID SID | -ASMSRVC service_name  
[-SYSPWD password] [-STARTMODE auto | manual] [-SRVCSTART system | demand]  
[-PFILE filename | -SPFILE] [-SHUTMODE normal | immediate | abort] [-TIMEOUT  
secs] [-RUNAS osusr/ospass]
```

where

- `-NEW` indicates that you are creating a new instance. This is a mandatory parameter.
- `-SID SID` is the name of the instance to create.



- `-SRVC service_name` is the name of the service to create (OracleServiceSID).
- `-ASMSID SID` is the name of the Automatic Storage Management (ASM) instance to create.
- `-ASMSRVC service_name` is the name of the ASM service to create.
- `-STARTMODE auto | manual` indicates whether to start the instance when the Oracle Database service is started. Default is `manual`.
- `-SRVCSTART system | demand` indicates whether to start the Oracle Database service on computer restart.
- `-PFILE filename` is the initialization parameter file to be used with this instance. Ensure that you specify the complete path name of this file, including drive letter.
- `-SPFILE` indicates that a server parameter file (SPFILE) be used during startup instead of a PFILE.
- `-TIMEOUT secs` sets the maximum time to wait (in seconds) before the service for a particular SID stops.

To create an instance called `PROD`, for example, you can enter:

```
C:\> oradim -NEW -SID prod -STARTMODE auto -PFILE
C:\oracle\admin\prod\pfile\init.ora
```

## Starting an Instance and Services

To use ORADIM to start an instance and services, enter

```
oradim -STARTUP -SID SID | -ASMSID SID [-SYSPWD password] [-STARTTYPE srvc |
inst | srvc,inst] [-PFILE filename | -SPFILE]
```

where

- `-STARTUP` indicates that you are starting an instance that already exists. This is a mandatory parameter.
- `-SID SID` is the name of the instance to start.
- `-ASMSID SID` is the name of the ASM instance to start.
- `-STARTTYPE srvc, inst` indicates whether to start the service or the instance. One or both values can be specified. If it is not specified, then the registry is checked for the current setting.

- STARTTYPE *srvc* is equivalent to running `net start oracleservice<sid>` from the command line.
- STARTTYPE *inst* is equivalent of running `startup` within SQL\*Plus.
- -PFILE *filename* is the initialization parameter file to be used with this instance. Ensure that you specify the complete path name of this file, including drive letter.
- -SPFILE indicates that a server parameter file (SPFILE) be used during startup instead of a PFILE.

To start an instance called *puma*, for example, you can enter:

```
C:\> oradim -STARTUP -SID puma -STARTTYPE inst -PFILE
C:\oracle\admin\prod\pfile\init.ora
```

## Stopping an Instance and Services

To use ORADIM to stop an instance, enter:

```
oradim -SHUTDOWN -SID SID | -ASMSID SID [-SYSPWD password] [-SHUTTYPE srvc |
inst | srvc,inst] [-SHUTMODE normal | immediate | abort]
```

where

- -SHUTDOWN indicates that you are stopping an instance. This is a mandatory parameter.
- -SID *SID* specifies the name of the instance to stop.
- -ASMSID *SID* is the name of the ASM instance to stop.
- -SHUTTYPE *srvc, inst* indicates whether to stop the service or the instance. One or both values can be specified. If it is not specified, then the registry is checked for the current setting.
- -SHUTMODE specifies how to stop an instance. This is an optional parameter. If you do not specify how to stop an instance, then *normal* is the default mode.

To stop an instance called *puma*, for example, you can enter:

```
C:\> oradim -SHUTDOWN -SID puma -SHUTTYPE srvc,inst
```

## Editing an Instance

You can edit an existing instance to change such values as instance name, startup mode, shutdown mode, and shutdown type. To use ORADIM to modify an instance, enter:

```
oradim -EDIT -SID SID | -ASMSID SID [-SYSPWD password] [-STARTMODE auto |
manual] [-SRVCSTART system | demand] [-PFILE filename | -SPFILE][SHUTMODE normal
| immediate | abort] [SHUTTYPE srvc | inst | srvc,inst]
```

where

- -EDIT indicates that you are modifying an instance. This is a mandatory parameter.
- -SID *SID* specifies the name of the instance to modify. This is a mandatory parameter.
- -ASMSID *SID* is the name of the ASM instance to modify.
- -STARTMODE indicates whether to start the instance when the Oracle Database service is started. Default is manual.
- -SRVCSTART *system* | *demand* indicates whether to start the Oracle Database service on computer restart.
- -PFILE *filename* specifies the initialization parameter file to be used with this instance. Ensure that you specify the complete path name of this file, including drive letter.
- -SPFILE indicates that a server parameter file (SPFILE) be used during startup instead of a PFILE.
- -SHUTMODE specifies how to stop an instance. This is an optional parameter. If you do not specify how to stop an instance, then normal is the default mode.
- -SHUTTYPE indicates whether to stop the service or the instance. One or both values can be specified. If it is not specified, then the registry is checked for the current setting.

To specify a new initialization parameter file for the instance prod, for example, you can enter:

```
C:\> oradim -EDIT -SID prod -PFILE C:\oracle\admin\lynx\pfile\init.ora
```

## Deleting an Instance

To use ORADIM to delete an instance, enter:

```
oradim -DELETE -SID SID | -ASMSID SID | -SRVC service_name | -ASMSRVC service_  
name
```

where

- `-DELETE` Indicates that you are deleting an instance or service. This is a mandatory parameter.
- `-SID SID` specifies the name of the SID to delete.
- `-SRVC service_name` specifies the name of the service to delete.
- `-ASMSID SID` is the name of the ASM instance to delete.
- `-ASMSRVC service_name` is the name of the ASM service to delete.

To delete an instance called `prod`, for example, you can enter:

```
C:\> oradim -DELETE -SID prod
```

---

---

# Postinstallation Configuration Tasks on Windows

This chapter describes configuration tasks you can perform to increase security and other configuration tasks you must perform before using Oracle *interMedia* and other Oracle options. Where appropriate, the chapter provides references to other guides for those configuration tasks.

This chapter contains these topics:

- [Resetting Passwords for Default Accounts](#)
- [NTFS File System and Windows Registry Permissions](#)
- [Configuring External Job Support for the Scheduler on Windows](#)
- [Oracle \*interMedia\* on Windows](#)
- [Configuring Oracle Text on Windows](#)
- [Configuring Oracle Spatial on Windows](#)
- [Configuring Advanced Replication on Windows](#)

---

---

**Note:** Directory path examples in this chapter follow **Optimal Flexible Architecture** (OFA) guidelines (for example, `ORACLE_BASE\ORACLE_HOME\rdms\admin`). If you specified non-OFA compliant directories during installation, then your directory paths will differ. See [Chapter 2, "Multiple Oracle Homes and Optimal Flexible Architecture"](#) for more information.

---

---

## Resetting Passwords for Default Accounts

Oracle Database installs with a number of default accounts. Database Configuration Assistant locks and expires most default database accounts upon successful installation. Oracle recommends changing all user passwords *immediately* after installation.

**See Also:** *Oracle Database Administrator's Guide* for more information on default database accounts and passwords

## NTFS File System and Windows Registry Permissions

Oracle recommends that you configure Oracle Database files, directories, and registry settings to allow only authorized database administrators (DBAs) to have full control. If you created a database using Database Configuration Assistant or upgraded a database using Oracle Database Upgrade Assistant, then no further action is required.

This section describes the permissions automatically set by Oracle Universal Installer, Database Configuration Assistant, and Oracle Database Upgrade Assistant and the steps to set these permissions manually.

This section contains these topics:

- [File Permissions](#)
- [Setting NTFS File System Security](#)
- [Setting Windows Registry Security](#)

**See Also:** Your Windows documentation for more information about modifying NTFS file system and Windows registry settings

## File Permissions

Beginning with Oracle9i release 2 (9.2), Oracle Universal Installer, Database Configuration Assistant, and Database Upgrade Assistant set file permissions when Oracle Database software is installed or upgraded.

This section contains these topics:

- [File Permissions Set by Oracle Universal Installer](#)
- [File Permissions Set by Database Configuration Assistant](#)
- [File Permissions Set by Database Upgrade Assistant](#)

### File Permissions Set by Oracle Universal Installer

During Oracle Database installation, by default Oracle Universal Installer installs software in *ORACLE\_BASE\ORACLE\_HOME*. Oracle Universal Installer sets the following permissions to this directory, and all files and directories under this directory:

- Administrators - Full Control
- System - Full Control
- Authenticated Users - Read, Execute and List Contents

---

---

**Important:** If these accounts already exist and possess more restrictive permissions, then the most restrictive permissions are retained. If accounts other than *Administrators*, *System*, and *Authenticated Users* already exist, then the permissions for these accounts are removed.

---

---

### File Permissions Set by Database Configuration Assistant

During database configuration, Database Configuration Assistant installs files and directories in the following default locations, where *database\_name* is the database name or SID:

- *ORACLE\_BASE\admin\database\_name* (administration file directories)
- *ORACLE\_BASE\oradata\database\_name* (database file directories)
- *ORACLE\_BASE\oradata\database\_name* (redo log files and control files)
- *ORACLE\_BASE\ORACLE\_HOME\database (SPFILESID.ORA)*

Database Configuration Assistant sets the following permissions to these directories, and all files and directories under these directories:

- Administrators - Full Control
- System - Full Control

---

---

**Important:** If these accounts already exist and possess more restrictive permissions, then the most restrictive permissions are retained. If accounts other than *Administrators* and *System* already exist, then the permissions for these accounts are removed.

---

---

### File Permissions Set by Database Upgrade Assistant

When an older version of the database is upgraded to Oracle Database 10g, Database Upgrade Assistant installs software in the following directories, where *database\_name* is the database name or SID:

- *ORACLE\_BASE*\admin\*database\_name* (administration files)
- *ORACLE\_BASE*\oradata\*database\_name* (database file directories)
- *ORACLE\_BASE*\oradata\*database\_name* (redo log files and control files)
- *ORACLE\_BASE*\ORACLE\_HOME\*database* (SPFILESID.ORA)

Database Upgrade Assistant sets the following permissions to these directories, and all files and directories under these directories:

- Administrators - Full Control
- System - Full Control

---

---

**Important:** If these accounts already exist and possess more restrictive permissions, then the most restrictive permissions are retained. If accounts other than Administrators and System already exist, then the permissions for these accounts are removed.

---

---

Beginning with Oracle Database 10g, Database Upgrade Assistant can also configure Enterprise Manager. If the "Enable daily backup" option is selected while configuring Enterprise Manager, then Database Upgrade Assistant shows a separate screen asking for Flash Recovery Area. Database Upgrade Assistant will try to create the directory structure in whatever file system location is specified if it does not exist. It will put the same set of file permissions to this location. The default location shown by DBUA for flash recovery area is:

- *ORACLE\_BASE*\flash\_recovery\_area

### Setting NTFS File System Security

To ensure that only authorized users have full file system permissions:

1. Go to Windows Explorer.
2. Set the following permissions for each directory or file:



Directory	Group and Permissions
<code>ORACLE_BASE\ORACLE_HOME</code>	<ul style="list-style-type: none"> <li>■ Administrators - Full Control</li> <li>■ System - Full Control</li> <li>■ Authenticated Users - Read, Execute and List Contents</li> </ul>
<code>ORACLE_BASE\admin\database_name</code>	<ul style="list-style-type: none"> <li>■ Administrators - Full Control</li> <li>■ System - Full Control</li> </ul>
<code>ORACLE_BASE\oradata\database_name</code>	<ul style="list-style-type: none"> <li>■ Administrators - Full Control</li> <li>■ System - Full Control</li> </ul>
<code>ORACLE_BASE\ORACLE_HOME\database\spfileSID.ora</code>	<ul style="list-style-type: none"> <li>■ Administrators - Full Control</li> <li>■ System - Full Control</li> </ul>

---

**Note:** Oracle Database uses the Windows LocalSystem built-in security account. Therefore, file permissions must be granted to the System account of the local computer running Oracle Database.

---

**See Also:** Your Windows online help for more information about how to modify NTFS file system and Windows registry settings

## Setting Windows Registry Security

Oracle recommends that you remove write permissions from users who are *not* Oracle Database DBAs or system administrators in `HKEY_LOCAL_MACHINE\SOFTWARE\ORACLE` of the Windows registry.

### To remove write permissions:

1. Open the registry.
2. Go to `HKEY_LOCAL_MACHINE\SOFTWARE\ORACLE`.
3. Select Permissions from the Security main menu.

The Registry Key Permissions dialog appears.

4. Remove write permissions from any users who are not Oracle Database DBAs or system administrators. Note that the `SYSTEM` account must have Full Control, since this is the account with which Oracle Database runs.

5. Ensure that user accounts that must run Oracle applications have read privileges.
6. Choose OK.
7. Exit the registry.

## Configuring External Job Support for the Scheduler on Windows

This release includes a new database scheduler to provide enterprise scheduling functionality. External jobs performed by the user are started using the OracleJobScheduler service. This service is disabled by default. In order to use the external jobs functionality, the administrator must set the username and password for the user account under which this service must run and enable the service.

Restricting execution of external jobs to a low-privileged user prevents unauthorized database users from gaining operating system level privileges, but it also places restrictions on the kinds of jobs that can be run. Jobs requiring a higher level of operating system privileges cannot be run by this mechanism.

## Oracle *interMedia* on Windows

Oracle *interMedia* includes the following components.

### Client

Oracle *interMedia* Client provides an Oracle Database *interMedia* Audio, Image, and Video Java interface that lets you use local (client-side) applications to manipulate or modify multimedia data stored in a network-accessible (server-side) database. To use the Java library, set environment variable CLASSPATH so that it contains the Oracle *interMedia* library.

Client also provides a simple *interMedia* Image sample (`SimpImg.exe`) that was developed using Microsoft Visual C++. `SimpImg.exe` locates and updates images, using *interMedia* Image in Oracle Database.

### Audio

Oracle *interMedia* Audio manages audio data in multiple file formats in Oracle Database. Types of audio data supported include conversations, songs, and other sounds in popular audio file formats. This makes it possible to integrate audio data with other application-specific object-relational data.

## Video

Oracle *interMedia* Video manages video data in multiple video file formats. This makes it possible to integrate video data with other application-specific object-relational data.

## Image

Oracle *interMedia* Image provides image storage, retrieval, and format conversion capabilities through an object data type (ODT). It also supports image storage, using Binary Large Objects (BLOBs), and references to image data residing in external files (BFILEs).

The Image component of Oracle *interMedia* also comes with a sample demonstration that shows how an image is extracted from Oracle Database.

## Locator

Oracle *interMedia* Locator enables Oracle Database to support online internet-based geocoding facilities for locator applications and proximity queries.

## Upgrading Oracle *interMedia* from an Earlier Release

If you upgrade from an earlier Oracle release to the current release, Oracle *interMedia* will be upgraded automatically if it is detected. If for some reason you want to upgrade *interMedia* manually, follow this procedure:

1. Upgrade the database.

2. Start SQL\*Plus:

```
C:\> sqlplus /NOLOG
```

3. Connect to Oracle Database with account SYSDBA:

```
SQL> CONNECT / AS SYSDBA
```

4. Run script `imdbma.sql`:

```
SQL> @ORACLE_BASE\ORACLE_HOME\ord\im\admin\imdbma.sql
```

5. If the script displays `NOT_INSTALLED`, then no prior release of Oracle *interMedia* was installed on your computer. You must install rather than upgrade Oracle *interMedia*.

6. If the script displays `INSTALLED`, then the current Oracle *interMedia* release is already installed on your computer.

7. If the script displays `u0nnnnn0.sql`, then Oracle *interMedia* release *nnnnn* is currently installed. For example, `u0800060.sql` means that Oracle Image Cartridge release 8.0.6.0.0 is currently installed.

8. Upgrade Oracle *interMedia* common files:

```
SQL> @ORACLE_BASE\ORACLE_HOME\ord\admin\u0nnnnn0.sql
```

9. Upgrade Oracle *interMedia*:

```
SQL> @ORACLE_BASE\ORACLE_HOME\ord\im\admin\u0nnnnn0.sql
```

10. Verify the upgrade:

```
SQL> CONNECT / AS ORDSYS
```

```
SQL> @ORACLE_BASE\ORACLE_HOME\ord\im\admin\imchk.sql
```

## Configuring Oracle *interMedia* Audio, Video, Image, and Locator

If you install Enterprise Edition, then Database Configuration Assistant starts automatically at the end of installation. If you choose any Database Configuration Assistant installation type other than Customized, then *interMedia* does not require manual configuration. All tasks described in this section are performed automatically.

If you select Customized installation, then Database Configuration Assistant will guide you through configuration of Oracle *interMedia*.

If you are creating and configuring a database manually, then you can configure Oracle *interMedia* Audio, Video, Image, and Locator as follows:

1. Start SQL\*Plus:

```
C:\> sqlplus /NOLOG
```

2. Connect to Oracle Database with account SYSDBA:

```
SQL> CONNECT / AS SYSDBA
```

3. Start the database (if necessary):

```
SQL> STARTUP
```

4. Run script `ordinst.sql`:

```
SQL> @ORACLE_BASE\ORACLE_HOME\ord\admin\ordinst.sql
```

5. Run script `iminst.sql`:

```
SQL> @ORACLE_BASE\ORACLE_HOME\ord\im\admin\iminst.sql
```

6. Exit SQL\*Plus:

```
SQL> EXIT
```

---



---

**Note:** If you manually copy your Oracle8i `listener.ora` and `tnsnames.ora` files into your Oracle Database network directory, then you must modify network configuration files `tnsnames.ora` and `listener.ora` on your server to enable **external routine** calls to work and *interMedia* to function properly. Follow the procedure in *Oracle Net Services Administrator's Guide*.

---



---

## Configuring Oracle *interMedia* Demos

To configure Oracle *interMedia* Audio, Video, and Image demos, follow instructions in `readme.txt` files at locations shown in [Table 5–1](#).

**Table 5–1** *interMedia* Demo Instructions

Demo	File Location
Audio	<code>ORACLE_BASE\ORACLE_HOME\ord\aud\demo</code>
Video	<code>ORACLE_BASE\ORACLE_HOME\ord\vid\demo</code>
Image	<code>ORACLE_BASE\ORACLE_HOME\ord\img\demo</code>

---



---

**Note:** These `readme.txt` files contain UNIX line breaks. If you simply double-click them, they will open in Notepad by default, and Notepad does not recognize UNIX line breaks. Use `write.exe` or `edit.com` instead.

---



---

Directory `\img\demo` also contains `demo_ordimg.mk`, the makefile to make *interMedia* Image demos for a Microsoft C compiler. But before you can build and run the demonstration, you must first modify it to adapt it to your environment.

To configure Oracle *interMedia* Locator demonstrations, go to the following directory:

```
ORACLE_BASE\ORACLE_HOME\md\demo\geocoder
```

Sample data that can be loaded into Oracle Database is in `nh_cs.sql`. Examples that show use of Locator functionality are in `geohttp.sql` and `geolocate.sql`. Examples of data indexes created by using Locator are in `geoindex.sql`.

## Configuring Oracle Text on Windows

Oracle Text enables text queries through SQL and **PL/SQL** from most Oracle interfaces. By installing Oracle Text with an Oracle Database server, client tools such as SQL\*Plus, Oracle Forms, and Pro\*C/C++ are able to retrieve and manipulate text in Oracle Database.

Oracle Text manages textual data in concert with traditional data types in Oracle Database. When text is inserted, updated, or deleted, Oracle Text automatically manages the change.

Your Oracle Text postinstallation tasks depend on your situation.

If you install Oracle Text from the CD-ROM and have a previous release of Oracle Text (formerly called *interMedia* Text) already installed, then see *Oracle Text Application Developer's Guide*.

If you **upgrade** your database, then you may be required to configure **Oracle Net** for external procedures. Otherwise, Oracle Text may not work. In any case other than upgrade, Oracle Net will be configured correctly by default to work with Oracle Text. See *Oracle Text Application Developer's Guide* and *Oracle Text Reference*.

If you are indexing formatted documents such as Microsoft Word, then you must set your environment to use the INSO filter before you can index your documentation set. For more information on setting up your environment for INSO filtering, see *Oracle Text Reference*.

Finally, if you install Oracle Text from the CD-ROM and do *not* have a previous release of Oracle Text installed, then Oracle Database is already configured for use with Oracle Text if one of the following is true:

- You created the database by using Database Configuration Assistant in standalone mode, and selected Typical database creation type.
- The database is a **starter database** that you created by installing Enterprise Edition, Standard Edition or Personal Edition.

- The database is a starter database that you created by performing the following sequence of steps:
  1. Select Oracle Database in the Available Products window.
  2. Install Enterprise Edition, Standard Edition, or Personal Edition in the Installation Types window.
  3. Select General Purpose in the Database Configuration window.

**See Also:** For more information about creating a starter database

- [Chapter 4, "Postinstallation Database Creation on Windows"](#)
- *Oracle Database Installation Guide for Windows*

If none of these is true, then you must configure Oracle Database for use with Oracle Text by doing one of the following:

- [Configuring Oracle Text Using Database Configuration Assistant](#)
- [Configuring Oracle Text Using Command-Line Tools](#)

### Configuring Oracle Text Using Database Configuration Assistant

To use Database Configuration Assistant to configure Oracle Database for use with Oracle Text at the time you create the database, simply select Oracle Text as the option to configure when prompted. To configure the database at a later time:

1. Start Database Configuration Assistant.  
Choose **Start > Programs > Oracle - HOME\_NAME > Configuration and Migration Tools > Database Configuration Assistant**.
2. Select **Configure database options in a database**.
3. Select the database to modify when prompted.
4. Select **Oracle Text** as the option to configure when prompted.

### Configuring Oracle Text Using Command-Line Tools

Manually configuring Oracle Database for use with Oracle Text consists of creating a tablespace for Oracle Text **data dictionary** tables and then creating **username** `ctxsys` and Oracle Text data dictionary tables.

1. Start SQL\*Plus:  

```
C:\> sqlplus /NOLOG
```

2. Connect to Oracle Database with account SYSDBA:

```
SQL> CONNECT / AS SYSDBA
```

3. Create a tablespace for Oracle Text data dictionary tables:

```
SQL> CREATE TABLESPACE tablespace_name DATAFILE 'ORACLE_BASE\oradata\db_
name\drsys01.dbf' SIZE 80m;
```

4. Connect AS SYSDBA:

```
SQL> CONNECT USERNAME/PASSWORD AS SYSDBA
```

5. Run script `dr0csys.sql` to create username `ctxsys`:

```
SQL> @ORACLE_BASE\ORACLE_HOME\ctx\admin\dr0csys.sql password default_
tablespace_name temporary_tablespace_name;
```

where:

- *password* is the password that you intend to use for username `ctxsys`.
- *default\_tablespace\_name* is the default tablespace for Oracle Text data dictionary tables. Set the default tablespace to the value of *tablespace\_name* in step 3.
- *temporary\_tablespace\_name* is the temporary tablespace for Oracle Text data dictionary tables. Set the temporary tablespace to the value of *tablespace\_name* in step 3.

6. Connect as `ctxsys`:

```
SQL> CONNECT ctxsys/password
```

7. Run script `dr0inst.sql` to create and populate Oracle Text data dictionary tables:

```
SQL> @ORACLE_BASE\ORACLE_HOME\bin\dr0inst.sql;
```

8. Run the language-specific default script, where *xx* is the language code (for example, *us*):

```
SQL> @ORACLE_BASE\ORACLE_HOME\ctx\admin\defaults\drdefxx.sql;
```

9. Exit SQL\*Plus:

```
SQL> EXIT
```



## Configuring Oracle Spatial on Windows

Oracle Spatial makes storage, retrieval, and manipulation of spatial data easier and more intuitive to users.

One example of spatial data is a road map. A road map is a two-dimensional object that contains points, lines, and polygons representing cities, roads, and political boundaries such as states. A road map represents geographic information. Locations of cities, roads, and political boundaries are projected onto a two-dimensional display or piece of paper, preserving relative positions and relative distances of objects.

If you install Oracle Spatial through Enterprise Edition, then no manual configuration is required. All Oracle Spatial configuration tasks are performed automatically.

If you install both Oracle Spatial and Oracle Database together through Enterprise Edition or Standard Edition Custom installation, then Database Configuration Assistant starts automatically at the end of installation. If you choose Custom installation and select Create new database, then the assistant asks if Oracle Spatial is to be configured automatically.

If you install Oracle Spatial during a separate installation from Enterprise Edition, then you must either start Database Configuration Assistant and select Configure database options in a database or configure Oracle Spatial manually.

To configure Oracle Spatial manually:

1. Start SQL\*Plus at the command prompt:

```
C:\> sqlplus /NOLOG
```

2. Connect to Oracle Database with account SYSDBA:

```
SQL> CONNECT / AS SYSDBA
```

3. Start the database (if necessary):

```
SQL> STARTUP
```

4. Run script `ordinst.sql`:

```
SQL> @ORACLE_BASE\ORACLE_HOME\ord\admin\ordinst.sql
```

5. Connect to the database as user **SYSTEM**:

```
SQL> CONNECT SYSTEM/password
```

6. Run script `mdinst.sql`:

```
SQL> @ORACLE_BASE\ORACLE_HOME\md\admin\mdinst.sql
```

7. Exit SQL\*Plus:

```
SQL> EXIT
```

---

---

**Note:** Script `mdinst.sql` has a variable `%MD_SYS_PASSWORD%` that Oracle Universal Installer will **instantiate** at installation time. Therefore, if you have changed the `mdsys` user's password, then be sure during a manual installation to remember also to update script `mdinst.sql` with that password.

---

---

## Configuring Advanced Replication on Windows

Oracle Database installs **replication** packages and procedures automatically rather than as a separate manual process. There are many configuration and usage possibilities with Advanced Replication.

This section describes how to manually configure Advanced Replication in Oracle Database. Follow the instructions *only* if you add Advanced Replication to an installation of Oracle Database that was not previously configured with this feature.

**See Also:** *Oracle Database Advanced Replication* for more information about Advanced Replication and for definitions of master sites and materialized view sites

Configuring Advanced Replication consists of the following steps:

- [Checking Tablespace and Rollback Segment Requirements](#)
- [Adding and Modifying Initialization Parameters](#)
- [Monitoring Data Dictionary Tables](#)

## Checking Tablespace and Rollback Segment Requirements

Recommended tablespace and rollback segment requirements for Advanced Replication are shown in [Table 5-2](#).

**Table 5–2 Advanced Replication Tablespace/Rollback Segment Requirements**

<b>Tablespace/Rollback Segment</b>	<b>Minimum Free Space</b>
SYSTEM <sup>1</sup>	20 MB
UNDO TABLESPACE	10 MB
RBS	5 MB
TEMP	10 MB
USERS	No specific requirement

<sup>1</sup> Replication triggers and procedures are stored here.

## Adding and Modifying Initialization Parameters

If you use Advanced Replication, then certain parameter values must be added to the initialization parameter file, and others must be set to recommended values. Parameter names and values for the master site and materialized view sites are shown in [Table 5–3](#).

**Table 5–3 Advanced Replication Initialization Parameters**

<b>Parameter Name</b>	<b>Recommended Value</b>	<b>Site</b>
JAVA_POOL_SIZE	50 MB	master
DISTRIBUTED_LOCK_TIMEOUT	300 seconds	master
GLOBAL_NAMES	TRUE	master
OPEN_LINKS	4	master
PROCESSES	Add 9 to current value	master
JOB_QUEUE_PROCESSES	2 <sup>1</sup>	master
JOB_QUEUE_PROCESSES	2	materialized view

<sup>1</sup> Depends on number of n-way sites.

## Monitoring Data Dictionary Tables

If you use Advanced Replication and intend to set up a large number of replicated objects, then you are required to monitor the following data dictionary tables with the SQL `SELECT` command:

- `ARGUMENT$`
- `IDL_CHAR$`
- `IDL_UB1$`
- `IDL_UB2$`
- `IDL_SB4$`
- `I_ARGUMENT1`
- `I_SOURCE1I$`
- `SOURCE$`
- `TRIGGER`

If necessary, increase storage parameters to accommodate storage requirements of large numbers of replicated objects.

---

---

# Administering a Database on Windows

This chapter describes how to administer Oracle Database for Windows.

This chapter contains these topics:

- [Managing Oracle Database Services](#)
- [Starting and Shutting Down a Database with SQL\\*Plus](#)
- [Starting and Shutting Down a Database Using Services](#)
- [Starting Multiple Instances](#)
- [Creating and Populating Password Files](#)
- [Connecting Remotely to the Database as SYS](#)
- [Automatically Encrypted Database Passwords](#)
- [Creating Control, Data, and Log Files on Remote Computers](#)
- [Archiving Redo Log Files](#)

## Managing Oracle Database Services

This section tells you how to manage the services that Oracle Database installs on your computer.

**See Also:** *Oracle Database Installation Guide for Windows* for a list of the services installed

This section provides information on the following:

- [Oracle Database Service Naming Conventions for Multiple Oracle Homes](#)
- [Starting Oracle Database Services](#)
- [Stopping Oracle Database Services](#)
- [Auto-starting Oracle Database Services](#)

### Oracle Database Service Naming Conventions for Multiple Oracle Homes

Oracle Database for Windows lets you have **multiple Oracle homes** on a single computer. This feature, described in [Chapter 2, "Multiple Oracle Homes and Optimal Flexible Architecture"](#), affects **Oracle services** naming conventions. As you perform installations into Oracle home directories:

- You must accept default Oracle home name provided or specify a different name for each Oracle home directory.
- You are prompted to give a **system identifier** and global database name for each database installation.

### Starting Oracle Database Services

Oracle Database services must be started for you to use Oracle Database and its products. You can start Oracle Database services from three different locations:

- [Control Panel](#)
- [Command Prompt](#)
- [Starting Oracle Database Services](#)

---

---

**Note:** You can start Oracle Database when you start OracleServiceSID. See "[Starting and Shutting Down a Database Using Services](#)" on page 6-9 for information on **registry** parameters that enable you to do this.

---

---

## Control Panel

To start Oracle Database services from the Control Panel:

1. Access your Windows Services dialog.

**See Also:** Your Windows documentation for instructions

2. Find the service to start in the list, select it, and click **Start**.

If you cannot find OracleServiceSID in the list, then use ORADIM to create it.

3. Click **Close** to exit the Services dialog.

## Command Prompt

To start Oracle Database services from the command prompt, enter:

```
C:\> NET START service
```

where *service* is a specific service name, such as OracleServiceORCL.

## Oracle Administration Assistant for Windows

To start Oracle Database services from Oracle Administration Assistant for Windows:

1. Choose **Start > Programs > Oracle - HOME\_NAME > Configuration and Migration Tools > Administration Assistant for Windows**
2. Right-click the *SID*.

where *SID* is a specific instance name, such as orcl.

3. Click **Start Service**.

This starts service OracleServiceORCL.

## Stopping Oracle Database Services

On occasion (for example, when re-installing Oracle Database), you must stop Oracle Database services. You can stop Oracle Database services from three different locations:

- [Control Panel](#)
- [Command Prompt](#)
- [Oracle Administration Assistant for Windows](#)

---

---

**Note:** You can stop Oracle Database in normal, immediate, or abort mode when you stop `OracleServiceSID`. See "[Starting and Shutting Down a Database Using Services](#)" on page 6-9 for information on registry parameters that enable you to do this.

---

---

### Control Panel

To stop Oracle Database services from the Control Panel:

1. Access your Windows Services dialog.

**See Also:** Your Windows documentation for instructions

2. Select `OracleHOME_NAMETNSListener` and click **Stop**.

`OracleHOME_NAMETNSListener` is stopped.

3. Select `OracleServiceSID` and click **Stop**.

4. Click **OK**.

`OracleServiceSID` is stopped.

### Command Prompt

To stop Oracle Database services from the command prompt, enter:

```
C:\> net STOP service
```

where *service* is a specific service name, such as `OracleServiceORCL`.



## Oracle Administration Assistant for Windows

To stop Oracle Database services from Oracle Administration Assistant for Windows:

1. Choose **Start > Programs > Oracle - *HOME\_NAME* > Configuration and Migration Tools > Administration Assistant for Windows**.

2. Right-click the *SID*.

where *SID* is a specific instance name, such as `orcl`.

3. Click **Stop Service**.

This stops service `OracleServiceORCL`.

## Auto-starting Oracle Database Services

Oracle Database services can be set to start automatically whenever the Windows computer is restarted. You can turn auto-start on or off from two different locations:

- [Control Panel](#)
- [Oracle Administration Assistant for Windows](#)

### Control Panel

To use the Control Panel to configure when and how Oracle Database is started:

1. Access your Windows Services dialog.

**See Also:** Your Windows documentation for instructions

2. Select service `OracleServiceSID` and click **Startup**.
3. Choose **Automatic** from the **Startup Type** field.
4. Click **OK**.
5. Click **Close** to exit the Services dialog.

### Oracle Administration Assistant for Windows

To automatically start Oracle Database services from Oracle Administration Assistant for Windows:

1. Choose **Start > Programs > Oracle - *HOME\_NAME* > Configuration and Migration Tools > Administration Assistant for Windows**.

2. Right-click the *SID*.  
where *SID* is a specific instance name, such as `orcl`.
3. Choose **Startup/Shutdown Options**.
4. Choose the **Oracle Service** tab.
5. Choose **Automatic** in **Oracle Service Startup Type**.
6. Click **Apply**.
7. Click **OK**.

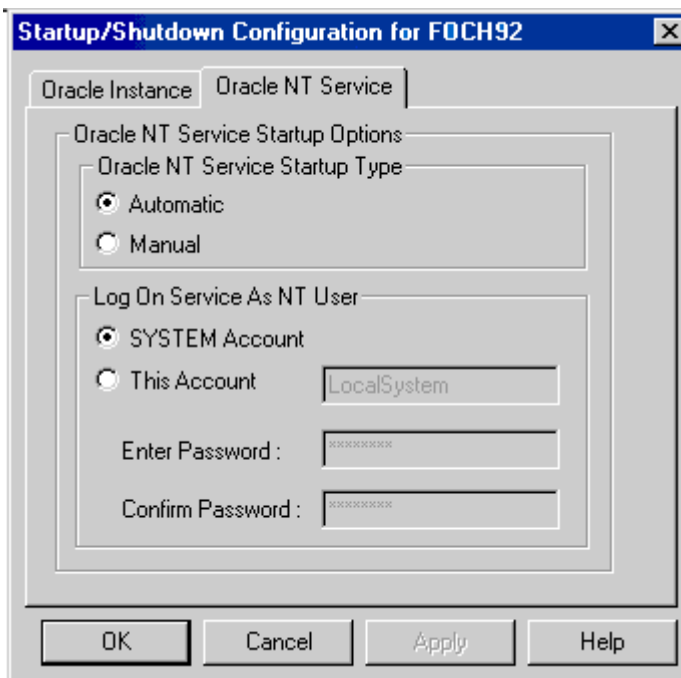

## Starting and Shutting Down a Database with SQL\*Plus

These instructions assume that a database instance has been created.

---

---

**Note:** Directory path examples in this chapter follow **Optimal Flexible Architecture** (OFA) guidelines (for example, `ORACLE_BASE\ORACLE_HOME\rdbms\admin`). If you specified non-OFA compliant directories during installation, then your directory paths will differ. See [Chapter 2, "Multiple Oracle Homes and Optimal Flexible Architecture"](#) for more information.

---

---

To start or shut down Oracle Database:

1. Go to your Oracle Database server.
2. Start SQL\*Plus at the command prompt:

```
C:\> sqlplus /NOLOG
```

3. Connect to Oracle Database with **username SYSDBA**:

```
SQL> CONNECT / AS SYSDBA
```

4. To start a database, enter:

```
SQL> STARTUP [PFILE=path\filename]
```

This command uses the **initialization parameter file** specified in `path\filename`. To start a database using a file named `init2.ora` located in `C:\ora92\admin\orcl\pfile`, for example, you would enter:

```
SQL> STARTUP PFILE=C:\ora92\admin\orcl\pfile\init2.ora
```

If no `PFILE` is specified, then the command looks for an `SPFILE` in `ORACLE_HOME\database`. If it finds one, then it uses it to start the database. If it does not find an `SPFILE`, then it uses the default initialization parameter file located in `ORACLE_BASE\ADMIN\db_name\pfile`.

5. To stop a database, enter:

```
SQL> SHUTDOWN [mode]
```

where `mode` is `normal`, `immediate`, or `abort`.

In a `normal` shutdown, Oracle Database waits for all currently-connected users to disconnect and disallows any new connections before shutting down. This is the default mode.

In an `immediate` shutdown, Oracle Database terminates and rolls back active transactions, disconnects clients, and shuts down.

In an `abort` shutdown, Oracle Database terminates active transactions and disconnects users; it does not roll back transactions. The database performs automatic **recovery** and rollback the next time it is started. Use this mode only in emergencies.

**See Also:** [Chapter 3, "Database Tools on Windows"](#) for a list of other tools that can start Oracle Database and this guide for information on options you can specify when starting your database.

## Starting and Shutting Down a Database Using Services

You can start or shut down Oracle Database by starting or stopping service `OracleServiceSID` in the Control Panel. Starting `OracleServiceSID` is equivalent to using the `STARTUP` command or manually entering:

```
C:\> oradim -STARTUP -SID SID [-STARTTYPE svrc | inst | svrc,inst] [-PFILE filename | -SPFILE]
```

Stopping `OracleServiceSID` is equivalent to using the `SHUTDOWN` command or manually entering:

```
C:\> oradim -SHUTDOWN -SID SID [-SHUTTYPE svrc | inst | svrc,inst] [-SHUTMODE normal | immediate | abort]
```

You can enable starting and stopping Oracle Database through `OracleServiceSID` two different ways:

- [Starting Oracle Database Services](#)
- [Setting Registry Parameters](#)

### Oracle Administration Assistant for Windows

To start or stop a database using Oracle Database Services from Oracle Administration Assistant for Windows:

1. Choose **Start > Programs > Oracle - HOME\_NAME > Configuration and Migration Tools > Administration Assistant for Windows**.

2. Right-click the *SID*.  
where *SID* is a specific instance name, such as ORCL.
3. Choose **Startup/Shutdown Options**.
4. Choose the **Oracle Instance** tab.
5. Select **Start up instance when service is started**, **Shut down instance when service is stopped**, or both.

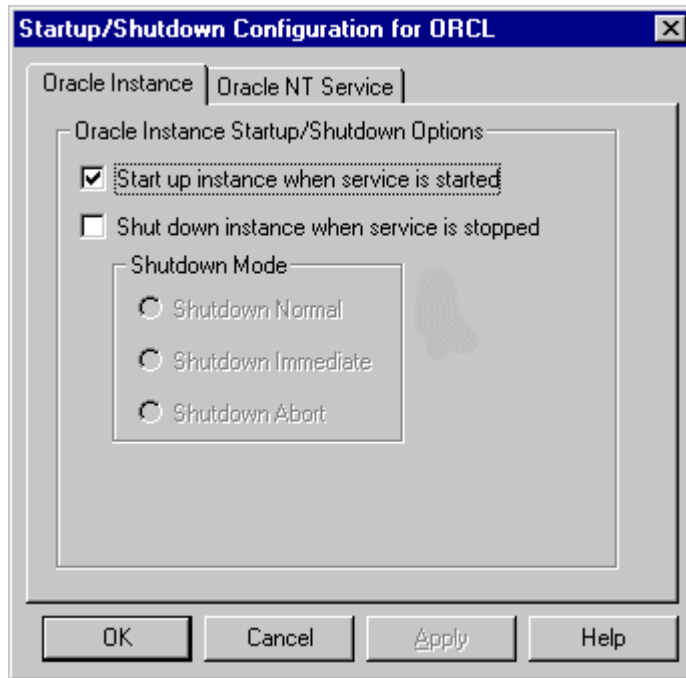

### Setting Registry Parameters

To start or stop Oracle Database through Oracle Database Services, set the following registry parameters to the indicated values:

- `ORA_SID_AUTOSTART`

When set to `true`, the default value, this parameter causes Oracle Database to start when `OracleServiceSID` is started.

- `ORA_SID_PFILE`

This parameter sets the full path to the initialization parameter file. If this entry is not present, then `oradim` will try to start the database with an `SPFILE` or `PFILE` from `ORACLE_HOME\database`.

- `ORA_SHUTDOWN`

When set to `true`, this parameter enables the selected instance of Oracle Database to be shut down when `OracleServiceSID` is stopped. This includes any database in the current Oracle home. Default value is `false`.

- `ORA_SID_SHUTDOWN`

When set to `true`, the default value, this parameter causes the instance of Oracle Database identified by the `SID` value to shut down when `OracleServiceSID` is stopped manually—using either the Control Panel or Net stop command.

---

---

**Caution:** If `ORA_SHUTDOWN` or `ORA_SID_SHUTDOWN` is set to `false`, then manually shutting down `OracleServiceSID` will still shut down Oracle Database. But it will be an abnormal shutdown, and Oracle does not recommend it.

---

---

The following two registry parameters are optional:

- `ORA_SID_SHUTDOWNTYPE`

This parameter controls database shutdown mode. Set it to `a` (`abort`), `i` (`immediate`), or `n` (`normal`). Default mode is `i` (`immediate`) if you do not set this parameter.

- `ORA_SID_SHUTDOWN_TIMEOUT`

This parameter sets maximum time to wait before the service for a particular `SID` stops.

The registry location of these required and optional parameters is determined by the number of Oracle home directories on your computer. If you have only one Oracle home directory, then these parameters belong in:

```
HKEY_LOCAL_MACHINE\SOFTWARE\ORACLE\HOME0
```

If you have multiple Oracle home directories, then these parameters belong in:

```
HKEY_LOCAL_MACHINE\SOFTWARE\ORACLE\HOMEID
```

where *ID* is incremented for each additional Oracle home directory on your computer.

---

---

**Note:** If you use ORADIM to create or edit instances, then it automatically sets the relevant registry parameters to their appropriate values.

---

---

**See Also:** [Chapter 14, "Configuration Parameters and the Registry"](#) for instructions on adding and editing registry parameters

### Starting or Stopping OracleServiceSID from the Control Panel

1. To start the database, start **OracleServiceSID**.

This automatically starts ORADIM and issues the `-STARTUP` command using the **initialization parameter file** identified by `ORA_SID_PFILE`.

2. To stop the database, stop **OracleServiceSID**.

This automatically starts ORADIM, which issues the `-SHUTDOWN` command in the mode indicated by `ORA_SID_SHUTDOWNTYPE`, and shuts down Oracle Database.

**See Also:** Your Windows documentation for instructions on starting and stopping services.

## Starting Multiple Instances

1. Start the service for each instance using ORADIM or the Services dialog of the Control Panel.
2. At the command prompt set the `ORACLE_SID` configuration parameter to the *SID* for the first instance to run:

```
C:\> SET ORACLE_SID=SID
```

where *SID* is the name of the Oracle Database instance.

3. Start SQL\*Plus:

```
C:\> sqlplus /NOLOG
```

4. Connect AS SYSDBA:

```
SQL> CONNECT / AS SYSDBA
```

5. Start up the first instance:

```
SQL> STARTUP PFILE=ORACLE_BASE\admin\db_name\pfile\init.ora
```

where *ORACLE\_BASE* is *c:\oracle* (unless you changed it during installation) and *db\_name* is the name of the instance.

6. Repeat Steps 2-5 for the other instances to run.

## Creating and Populating Password Files

Use Password Utility to create password files. Password Utility is automatically installed with Oracle Database utilities. Password files are located in directory *ORACLE\_BASE\ORACLE\_HOME\DATABASE* and are named *PWDsid.ORA*, where *SID* identifies the Oracle Database instance. Password files can be used for local or remote connections to Oracle Database.

To create and populate a password file:

1. Create a password file with the Password Utility:

```
C:\> orapwd FILE=PWDsid.ora PASSWORD=password ENTRIES=max_users
```

where

- *FILE* specifies the password filename.
- *SID* identifies the database instance.
- *PASSWORD* sets the password for account SYS.
- *ENTRIES* sets maximum number of entries in password file. This corresponds to maximum number of distinct users allowed to connect to the database simultaneously with either the **SYSDBA** or the **SYSOPER** DBA **privilege**.



2. Set initialization parameter file parameter `REMOTE_LOGIN_PASSWORDFILE` to `exclusive`, `shared`, or `none`.

`exclusive` specifies that only one instance can use the password file and that the password file contains names other than `SYS`. In search of the password file, Oracle Database looks in the registry for the value of parameter `ORA_SID_PFILE`. If no value is specified, then it looks in the registry for the value of parameter `ORA_PFILE`, which points to a file containing usernames, passwords, and privileges. If that is not set, then it uses the default:

```
ORACLE_BASE\ORACLE_HOME\DATABASE\PWDsid.ORA.
```

The default value is `shared`. It specifies that multiple instances (for example, a Real Application Clusters environment) can use the password file. However, the only user recognized by the password file is `SYS`. Other users cannot log in with `SYSOPER` or `SYSDBA` privileges even if those privileges are granted in the password file. The `shared` value of this parameter affords backward compatibility with earlier Oracle releases. Oracle Database looks for the same files as it does when the value is `exclusive`.

`none` specifies that Oracle Database ignores the password file and that **authentication** of privileged users is handled by the Windows operating system. This is the default setting.

3. Start SQL\*Plus:

```
C:\> sqlplus /NOLOG
```

4. Connect AS SYSDBA:

```
SQL> CONNECT / AS SYSDBA
```

5. Start Oracle Database:

```
SQL> STARTUP
```

6. Grant appropriate privileges to each user. Users who must perform database administration, for example, would be granted privilege `SYSDBA`:

```
SQL> GRANT SYSDBA TO scott;
```

If the grant is successful, then the following message displays:

```
Statement Processed.
```

This adds `scott` to the password file and enables `scott` to connect to the database with `SYSDBA` privileges. Use `SQL*Plus` to add or delete usernames, user passwords, and user privileges in password files.

---

---

**Caution:** Copying or manually moving password files may result in `ORADIM` being unable to find a password to start an instance.

---

---

## Viewing and Hiding the Password File

The password file is not automatically hidden. It can be made invisible and visible again from two different locations:

- [Command Prompt](#)
- [Windows Explorer](#)

---

---

**Note:** The password file must be visible before it can be moved, copied, or deleted.

---

---

### Command Prompt

1. To see the password file, enter:

```
ORACLE_BASE\ORACLE_HOME\database> attrib
```

The password file is displayed as `PWDsid.ora`:

```
A      ORACLE_BASE\ORACLE_HOME\database\oradba.exe
A      ORACLE_BASE\ORACLE_HOME\database\OraDim.Log
A      ORACLE_BASE\ORACLE_HOME\database\PWDsid.ora
A      ORACLE_BASE\ORACLE_HOME\database\SPFILEsid.ora
```

2. To make the password file invisible, enter:

```
ORACLE_BASE\ORACLE_HOME\database> attrib +H PWDsid.ora
```

3. To see the effect of the change, enter:

```
ORACLE_BASE\ORACLE_HOME\database> attrib
```

The password file is now hidden:

```
A      ORACLE_BASE\ORACLE_HOME\database\oradba.exe
A      ORACLE_BASE\ORACLE_HOME\database\OraDim.Log
```

```
A H ORACLE_BASE\ORACLE_HOME\database\PWDsid.ora
A   ORACLE_BASE\ORACLE_HOME\database\SPFILEsid.ora
```

4. To make the password file visible again, enter:

```
ORACLE_BASE\ORACLE_HOME\database> attrib -H PWDsid.ora
```

## Windows Explorer

To make the password file invisible or visible again:

1. Navigate to directory `ORACLE_BASE\ORACLE_HOME\database`.
2. Right-click **PWDsid.ora**.
3. Choose **Properties**.

The `PWDsid.ora` Properties dialog opens.

4. In **Attributes**, check or clear the checkbox next to **Hidden**.
5. Click **OK**.

To view or hide an invisible password file:

1. Navigate to directory `ORACLE_BASE\ORACLE_HOME\database`.
2. Choose **Folder Options** from the **View** main menu.
3. Choose the **View** tab.
4. To view an invisible password file, choose **Show hidden files and folders**.
5. To hide a visible password file, choose **Do not show hidden files and folders**.
6. Click **OK**.

## Connecting Remotely to the Database as SYS

When connecting to the **starter database** from a **remote computer** as `SYS`, you must use a different password from the one described in *Oracle Database Installation Guide for Windows* when logging on with `SYSDBA` privileges. This is because the password file enables database access in this situation and it requires the password `oracle` for this purpose.

## Automatically Encrypted Database Passwords

With Oracle Database, the password used to verify a **remote database** connection is automatically encrypted. Whenever a user attempts a remote login, Oracle Database encrypts the password before sending it to the remote database. If the connection fails, then the failure is noted in the operating system audit log.

---

---

**Note:** Configuration parameter `ORA_ENCRYPT_LOGIN` is retained for backward compatibility and is set to `true` by default. See [Chapter 14, "Configuration Parameters and the Registry"](#) for instructions on adding and setting configuration parameters in the registry.

---

---

## Creating Control, Data, and Log Files on Remote Computers

Oracle Database can access database files on a **remote computer** using Universal Naming Convention (UNC), but it may degrade database performance and network reliability. UNC is a PC format for specifying locations of resources on a local area network. UNC uses the following format:

```
\\server-name\shared-resource-path-name
```

For example, UNC specification for file `system01.dbf` in directory `C:\oracle\oradata\orcl` on shared server `argon` would be:

```
\\argon\oracle\oradata\orcl\system01.dbf
```

Locations of archive log files cannot be specified using UNC. Always set initialization parameter `LOG_ARCHIVE_DEST_n` to a mapped drive. If you set it to a UNC specification, then Oracle Database does not start and you receive the following errors:

```
ORA-00256: error occurred in translating archive text string '\meldell\rmdrive'  
ORA-09291: sksachk: invalid device specified for archive destination  
OSD-04018: Unable to access the specified directory or device  
O/S-Error: (OS 2) The system cannot find the file specified
```

An ORA-00256 error also occurs if you enter `\\meldell\rmdrive` or `\\meldell\rmdrive`. Control files required the additional backslashes for Oracle8 release 8.0.4, but **redo log files** and datafiles did not.

## Archiving Redo Log Files

If you installed Oracle Database through the Typical installation, then it is created in NOARCHIVELOG mode. If you created your database through the Custom option of Database Configuration Assistant, then you had the choice of either ARCHIVELOG or NOARCHIVELOG.

In NOARCHIVELOG mode, redo logs are not archived. Setting your archive mode to ARCHIVELOG and enabling automatic archiving causes **redo log files** to be archived. This protects Oracle Database from both instance and disk failure.

This section describes how to change archive mode to ARCHIVELOG and enable automatic archiving.

**See Also:** For complete descriptions of ARCHIVELOG and NOARCHIVELOG modes, see "Managing Archived Redo Logs" in *Oracle Database Administrator's Guide*

### Changing Archive Mode to ARCHIVELOG

1. Start SQL\*Plus at the command prompt:  
C:\> sqlplus /NOLOG
2. Connect to Oracle Database as SYSDBA:  
SQL> CONNECT / AS SYSDBA
3. If the database is open, then shut it down:  
SQL> SHUTDOWN
4. Next, **mount** the database:  
SQL> STARTUP MOUNT
5. Enter the following command:  
SQL> ARCHIVE LOG LIST

The following output indicates the database is not in archive mode:

Database log mode	No Archive Mode
Automatic archival	Disabled
Archive destination	%RDBMS%\
Oldest online log sequence	34
Current log sequence	37

6. Change archive mode to ARCHIVELOG:

```
SQL> ALTER DATABASE ARCHIVELOG;
```

7. Enter the following command:

```
SQL> ARCHIVE LOG LIST
```

The following output indicates the database is now in archive mode:

Database log mode	Archive Mode
Automatic archival	Disabled
Archive destination	%RDBMS%\
Oldest online log sequence	34
Current log sequence	37

8. Open the database:

```
SQL> ALTER DATABASE OPEN;
```

## Enabling Automatic Archiving

1. Open file `ORACLE_BASE\ADMIN\db_name\pfile\init.ora`.
2. Find the following three initialization parameters:

```
# LOG_ARCHIVE_START = true
# LOG_ARCHIVE_DEST_1 = %ORACLE_HOME%\database\archive
# LOG_ARCHIVE_FORMAT = "%ORACLE_SID%%T%TS%S.ARC"
```

3. Remove the # sign from in front of each.

---

---

**Note:** Double quotation marks around LOG\_ARCHIVE\_FORMAT

---

---

4. Edit the LOG\_ARCHIVE\_DEST\_n value to identify an existing drive and directory in which to archive your filled redo logs.

---

---

**Note:** Default size of Redo logs is approximately 100 MG.

---

---

5. Edit the LOG\_ARCHIVE\_FORMAT value to indicate the appropriate archiving format:  
  
%%ORACLE\_SID%%T.ARC specifies the **thread** number. This number is padded to the left by zeroes. The default value is one with a range of up to three characters. Example: SID0001.ARC  
  
%%ORACLE\_SID%%S.ARC specifies the log sequence number. This number is padded to the left by zeroes. The default value is one with a range of up to five characters. Example: SID0001.ARC  
  
%%ORACLE\_SID%%t.ARC specifies the thread number. The number is not padded. The default value is one with no range limit on characters. Example: SID1.ARC  
  
%%ORACLE\_SID%%s.ARC specifies the log sequence number. The number is not padded. The default value is one with no range limit on characters. Example: SID1.ARC
6. Save your changes.
7. Exit the file.
8. Shut down the database:  
  
SQL> SHUTDOWN
9. Restart the database  
  
SQL> STARTUP
10. Enter the following command:  
  
SQL> ARCHIVE LOG LIST

The following output indicates that automatic archiving of redo log files is enabled and an archiving destination is specified:

Database log mode	Archive Mode
Automatic archival	Enabled
Archive destination	C:\BACKUP
Oldest online log sequence	34
Current log sequence	37





---

---

# Monitoring a Database on Windows

This chapter describes how to monitor Oracle Database for Windows.

This chapter contains these topics:

- [Database Monitoring Overview](#)
- [Using Oracle Counters for Windows Performance Monitor](#)
- [Using Event Viewer](#)
- [Trace Files](#)
- [Alert Files](#)
- [Viewing Threads](#)

## Database Monitoring Overview

Table 7–1 describes tools that enable you to monitor Oracle Database.

**Table 7–1 Database Monitoring Tools**

Tool	Functionality
Oracle Counters for Windows Performance Monitor	Monitor database objects, such as CPU usage, buffer cache, or a background <b>process</b> .
Event Viewer	Monitor database events.
Trace Files	Record occurrences and exceptions of database operations
Alert Files	Record important information about error messages and exceptions during database operations.
Oracle Enterprise Manager Database Management Packs	Monitor and tune using tools with real-time graphical performance information. <b>See Also:</b> Your Oracle Enterprise Manager documentation set for more information
Oracle Administration Assistant for Windows	View information on or terminate any Oracle <b>thread</b> .

**See Also:** *Oracle Database Performance Tuning Guide* for general tuning information

## Using Oracle Counters for Windows Performance Monitor

Oracle Counters for Windows Performance Monitor is a graphical tool for measuring the performance of Oracle Database for Windows objects on a local server or other servers on a network. This tool is the same in appearance and operation as Windows Performance Monitor, except it has been preloaded with Oracle Database performance elements.

On each computer, you can view behavior of objects, such as buffer cache, **data dictionary** cache, datafiles, threads, and processes. An object is a graphical representation of an element in your system. Every element, resource, and device in your system can be represented as an object.

---

---

**Note:** Before using Oracle Counters for Windows Performance Monitor to view Oracle-specific counters, you must specify the `SYSTEM` password using `OPERFCFGver.exe` or Oracle Administration Assistant for Windows. See ["Using OPERFCFGver"](#) on page 14-18 or ["Using Oracle Administration Assistant for Windows"](#) on page 14-19 for instructions.

---

---

A set of counters is associated with each object. A counter is a unit of measurement used by Performance Monitor to display activity. The type of activity the counter measures is dependent upon type of object.

Certain types of objects and their respective counters are present on all systems. Other counters, such as application-specific counters, appear only if the computer is running the associated software.

Each of these objects has an associated set of counters that provide information about device usage, queue lengths, delays, and information used to measure throughput and internal congestion.

## Registry Information

When you install Oracle Counters for Windows Performance Monitor, values are automatically set in the **registry** as described in [Chapter 14, "Configuration Parameters and the Registry"](#).

Oracle Counters for Windows Performance Monitor lets you monitor only one database **instance** at a time. For this reason, the registry contains the following values:

- Hostname
- Username
- Password

Use `OPERFCFGver` to change these values. Oracle recommends setting the security level on each of these registry values.

**See Also:** [Chapter 14, "Configuration Parameters and the Registry"](#) for instructions on how to use `OPERFCFGver`

To use Oracle Counters for Windows Performance Monitor for another database instance on the same computer or a UNIX computer, change the values appropriately in the registry. You can also monitor non-Windows installations of Oracle Database by changing `Hostname` registry value so it points to another computer specified in file `tnsnames.ora`.

## Accessing Oracle Counters for Windows Performance Monitor

To access Oracle Counters for Windows Performance Monitor:

Choose **Start > Programs > Oracle - HOME\_NAME > Configuration and Migration Tools > Oracle Counters for Windows Performance Monitor**.

Oracle Counters for Windows Performance Monitor has four views you can choose from the View menu:

- Chart view displays database activity as it occurs.
- Alert view lets you know when certain minimum performance criteria are not being met, or maximum criteria are being exceeded.
- Log view maintains continuous records on performance.
- Report view saves information about specific criteria.

**See Also:** Your Windows documentation for complete information about the four views

## Modifying Views

For each view you can decide objects to monitor, what counters to use for each object, and graphical attributes of the view. When an object is chosen, it is assigned a counter, a color, and added to the status bar at the bottom of Oracle Counters for Windows Performance Monitor.

To add objects to a view:

1. Choose **Add To** (Chart, Alert, Log, Report) from the **Edit** menu.  
The Add to Chart dialog appears.
2. In the **Computer** list, select the computer to monitor.
3. In the **Object** list, select the object or objects to monitor, then click **Add**.

If no data or Oracle Database objects appear, then either Oracle Database is not running or an invalid host string or password has been entered. If the database is not started, then exit Oracle Counters for Windows Performance Monitor,

start the database, and restart Oracle Counters for Windows Performance Monitor.

4. In the **Counter** list, select one or more counters for each object you have selected. Note that the contents of the Counter list change depending upon your selection in the Object list. For details on how a counter works, highlight the counter and click **Explain**.
5. In the **Instance** list, select an instance for this counter.
6. In the **Color** list, choose a color for the display of the selected counter.
7. In the **Scale** list, choose the scale at which to display the counter.
8. In the **Width** list, specify the width of the line on the graph.
9. In the **Style** list, choose a style for your graph line.
10. Click **Done** when you are finished.

## Understanding Oracle Database Performance Objects

All Oracle Database system resources that can be monitored through Oracle Counters for Windows Performance Monitor begin with 'Oracle Database'. This section lists Oracle Database objects and describes their associated counters. These measures are defined in

`ORACLE_BASE\ORACLE_HOME\dfs\PERFver.ora`

**See Also:** *Oracle Database Performance Tuning Guide* for additional information on these objects

---

---

**Note:** You can monitor only one instance at a time using Oracle Counters for Windows Performance Monitor on a given computer.

---

---

### Oracle Database Buffer Cache

The counter is `phyrds/gets %`. The percentage of `phyrds/gets` is calculated as a Miss ratio. The lower the Miss counter, the better. To improve performance, increase the number of buffers in the buffer cache, if memory is available on the computer. This value is not time-derived.

### Oracle Database Redo Log Buffer

The counter is redo log space requests. The value of this counter must be near zero. If this value increments consistently, then processes have had to wait for space in the [redo log buffer](#). In this case, it may be necessary to increase the size of the redo log buffer.

### Oracle Database Data Dictionary Cache

The counter is getmisses/gets %. The value of this counter must be less than 10 or 15% for frequently accessed data dictionary caches. If the ratio continues to increase over this threshold while your application is running, then increase the amount of memory available to the data dictionary cache.

To increase the memory available to the cache, increase the value of initialization parameter `SHARED_POOL_SIZE`. This value is not time-derived.

**See Also:** *Oracle Database Performance Tuning Guide* for more detailed information on tuning memory allocation in Oracle Database

### Oracle Database Library Cache

The counter is reloads/pins %. This is the percentage of SQL statements, [PL/SQL](#) blocks, and object definitions that required reparsing. Total Reloads must be near zero. If the ratio of Reloads to Pins is greater than 1%, then reduce the library cache misses. This value is not time-derived.

### Oracle Database Data Files

The counters are phyrdys/sec and phywrts/sec. These values are time-derived. Disk contention occurs when multiple processes try to access the same disk simultaneously. Depending on results from monitoring disk activity, corrective actions could include:

- Distributing I/O
- Separating datafiles and [redo log files](#)
- Separating tables and indexes
- Striping table data

### Oracle Database DBWR stats1

The two counters available, buffers scanned/sec and LRU scans/sec, are helpful in tuning Buffer Cache. Buffers scanned/sec is the number of buffers DBWR scanned

in each second. The buffers scanned are on the LRU (Least Recently Used) list. LRU scans/sec is the number of times DBWR scanned the (Least Recently Used) buffer list in each second.

### **Oracle Database DBWR stats2**

The two counters available, timeouts/sec and checkpoints/sec, are helpful in determining how much work DBWR has been requested to perform. Timeouts/sec is the number of times DBWR timed-out in each second. DBWR is on a three second timeout interval. If DBWR has not been posted within a three second interval, then it times out.

Checkpoints/sec is the number of checkpoint messages processed by database writer in each second. Whenever a checkpoint occurs, DBWR must be messaged (posted) to "write dirty buffers to disk".

### **Oracle Database Dynamic Space Management**

The counter is recursive calls/sec. Dynamic extension causes Oracle Database to execute SQL statements in addition to those SQL statements issued by user processes. These SQL statements are called recursive calls.

If Oracle Database makes excessive recursive calls while an application is running, then it may be necessary to determine the cause. Examine the recursive calls statistic through dynamic performance table V\$SYSSTAT.

### **Oracle Database Free List**

The counter is free list waits/requests %. Contention for free lists is reflected by contention for free data blocks in buffer cache. You can determine if contention for free lists is reducing performance by querying V\$WAITSTAT.

If the number of free list waits for free blocks is greater than 1% of the total number of requests, then consider adding more free lists to reduce contention.

### **Oracle Database Sorts**

The available counters are sorts in memory/sec and sorts on disk/sec. The default sort area size is adequate to hold all data for most sorts. However, if your application often performs large sorts on data that does not fit into the sort area, then you may increase sort area size.

## Oracle Counters for Windows Performance Monitor Troubleshooting Information

If no data or Oracle Database objects appear in the Objects list of the Add to (Chart, Alert, Log, Report) dialog, then:

1. Ensure that Oracle Database is running. If it is not running, then exit Oracle Counters for Windows Performance Monitor, and start the database.
2. If the database is running but no data or Oracle Database objects appear, then check the error file for Oracle Counters for Windows Performance Monitor:

```
ORACLE_BASE\ORACLE_HOME\dfs\OPERFver.log
```

If the log file indicates an invalid host string or password, then check the registry for correct values for `Hostname`, `Password`, and `Username`. See "[HKEY\\_LOCAL\\_MACHINE\SYSTEM\CurrentControlSet\Services](#)" on page 14-8 for further information about these values.

3. Restart Oracle Counters for Windows Performance Monitor.

## Using Event Viewer

Oracle Database for Windows problems and other significant occurrences are recorded as events in an application event log. View and manage these recorded events in Event Viewer.

To access Event Viewer:

1. Choose **Start > Programs > Administrative Tools > Event Viewer**.

The Event Viewer window appears.

2. Choose **Application** from the **Log** menu.

[Figure 7-1](#) displays the Application view window, [Table 7-2](#) shows what is recorded in each column, and [Table 7-3](#) interprets icons that appear at the left edge of the viewer.



Figure 7-1 Application View Window

Date	Time	Source	Category	Event	User	Computer
7/26/98	9:34:27 AM	Perflib	None	1011	N/A	BGELERNT-NT
7/26/98	9:34:27 AM	Perflib	None	1011	N/A	BGELERNT-NT
7/24/98	4:48:22 PM	Oracle.orcl	None	16	N/A	BGELERNT-NT
7/24/98	4:48:21 PM	Oracle.orcl	None	12	N/A	BGELERNT-NT
7/24/98	4:48:18 PM	Oracle.orcl	None	8	N/A	BGELERNT-NT
7/24/98	4:48:18 PM	Oracle.orcl	None	34	N/A	BGELERNT-NT
7/24/98	3:06:59 PM	Oracle.orcl	None	34	N/A	BGELERNT-NT
7/23/98	12:23:09 PM	Oracle.orcl	None	34	N/A	BGELERNT-NT
7/23/98	12:08:14 PM	Oracle.orcl	None	5	N/A	BGELERNT-NT
7/23/98	12:08:14 PM	Oracle.orcl	None	5	N/A	BGELERNT-NT
7/23/98	12:08:14 PM	Oracle.orcl	None	5	N/A	BGELERNT-NT
7/23/98	12:08:13 PM	Oracle.orcl	None	5	N/A	BGELERNT-NT
7/23/98	12:08:13 PM	Oracle.orcl	None	5	N/A	BGELERNT-NT
7/23/98	12:08:13 PM	Oracle.orcl	None	5	N/A	BGELERNT-NT
7/23/98	12:08:12 PM	Oracle.orcl	None	5	N/A	BGELERNT-NT

Table 7-2 Application View Definitions

Column Name	Definition
Date	Date event took place
Time	Time event took place
Source	Application that recorded event
Category	Classification of event
Event	Unique number assigned to event
Computer	Computer name on which event occurred

**Table 7-3 Event Viewer Icons**

Icon	Event Type	Suggested Action
Red Stop Sign	Error	Always check these icons.
Lower-case "i" in Blue Circle	Information	Noncritical system events. Check these icons only to track a specific event.
Exclamation Point in Yellow Circle	Warning	Special events, such as instance termination or services shutdown. Investigate these icons, but they are usually noncritical.

## Reading Event Viewer

Oracle Database for Windows events display with a source of Oracle.SID.

Event number 34 specifies an audit trail event. These events are recorded if parameter `AUDIT_TRAIL` is set to `db (true)` or `os` in the initialization parameter file. Option `os` enables system wide auditing and causes audited records to be written to Event Viewer. Option `db` enables system wide auditing and causes audited records to be written to the database audit trail (table `SYS.AUD$`). Some records, however, are written to Event Viewer.

Event numbers other than 34 specify general database activities, such as an instance being started or stopped.

When you double-click an icon in Event Viewer, the Event Detail dialog appears with more information about the selected event. [Figure 7-2](#), for example, shows details about EventID 1011. In the Description field you will find a text description of the event. In the Data field you can choose Bytes to see the information in hexadecimal format or Words to see DWORDS for the same data.

Figure 7-2 Event Detail Dialog

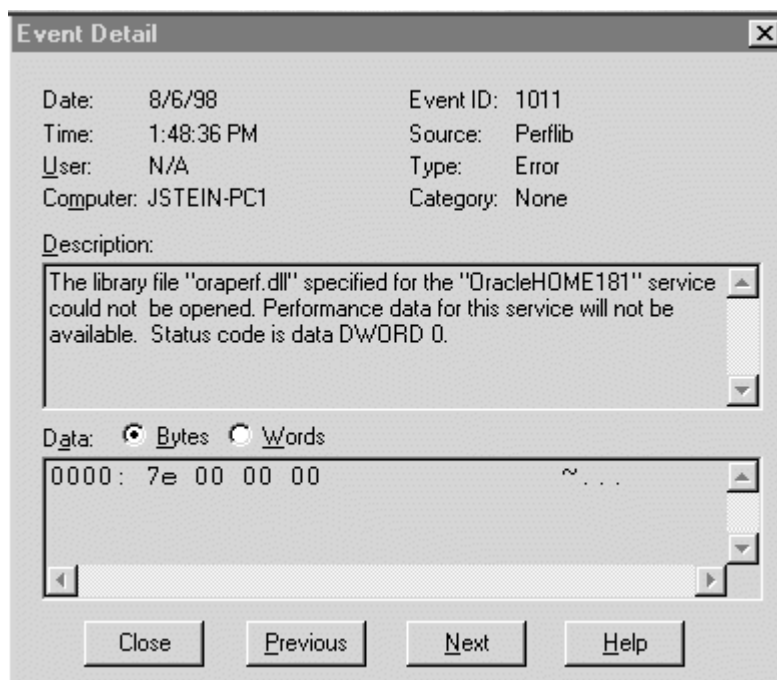

**See Also:** Microsoft Windows documentation for more information on using Event Viewer

## Managing Event Viewer

Setting `AUDIT_TRAIL` to `db` or `os` causes more records to be written to Event Viewer. This can fill up the Event Viewer log file. Follow these procedures to increase log file size:

1. Choose **Log Settings** from the **Log** menu.  
The Event Log Settings dialog appears.
2. Adjust the setting in the **Maximum Log Size** field to an appropriate level.
3. Click **OK**.

You are returned to Event Viewer.

---

---

**Caution:** Audit information cannot be spooled to a file. Parameter `AUDIT_FILE_DEST` is not supported in Windows and should not be added to the initialization parameter file.

---

---

## Trace Files

Oracle Database for Windows background threads use trace files to record occurrences and exceptions of database operations, as well as errors. Background thread trace files are created regardless of whether parameter `BACKGROUND_DUMP_DEST` is set in the [initialization parameter file](#). If `BACKGROUND_DUMP_DEST` is set, then trace files are stored in the directory specified. If the parameter is not set, then trace files are stored in directory `ORACLE_BASE\ADMIN\db_name\bdump`.

Oracle Database creates a different [trace file](#) for each background thread. The name of the trace file contains the name of the background thread, followed by the extension ".TRC". Sample trace file syntax includes:

- `SIDDBWR.TRC`
- `SIDSMON.TRC`

where `SID` is the name of the instance.

Trace files are also created for user threads if parameter `USER_DUMP_DEST` is set in the initialization parameter file. Trace files for user threads have the form `ora#####.trc`, where `#####` is a 5-digit number indicating the Windows thread ID.

## Alert Files

Alert files contain important information about error messages and exceptions that occur during database operations. Each Oracle Database for Windows instance has one alert file; information is appended to the file each time you start the instance. All threads can write to the alert file.

For example, when automatic archiving of redo logs is halted because no disk space is available, a message is placed in the alert file. The alert file is the first place to check if something goes wrong with the database and the cause is not immediately obvious.

The alert file is named `alert_#SID.log` and is found in the directory specified by parameter `BACKGROUND_DUMP_DEST` in the initialization parameter file. If parameter `BACKGROUND_DUMP_DEST` is not set, then file `alert_#SID.log` is

---

generated in `ORACLE_BASE\admin\db_name\bdump`. Alert files should be deleted or archived periodically.

## Viewing Threads

To view information on Oracle Database threads using Oracle Administration Assistant for Windows, you must either enable Windows native authentication for the database or run utility `ocfgutil.exe` with arguments *username* and *password*. The utility stores the username and password in the following registry location:

```
HKEY_LOCAL_MACHINE\SYSTEM\CurrentControlSet\Services\OracleOraConfig
```

When Windows native authentication is not enabled, Oracle Remote Configuration Agent retrieves the username and password from this registry key to log in to the database.

To view information on Oracle Database threads using Oracle Administration Assistant for Windows:

1. Choose **Start > Programs > Oracle - HOME\_NAME > Configuration and Migration Tools > Administration Assistant for Windows**.
2. Right-click the *SID*, where *SID* is a specific instance name, such as `orcl`.
3. Choose **Process Information**.

The Process Information dialog appears, listing name, type, user, thread ID, and CPU usage for each Oracle Database thread.

4. To terminate a thread, select it and click **Kill Thread**.

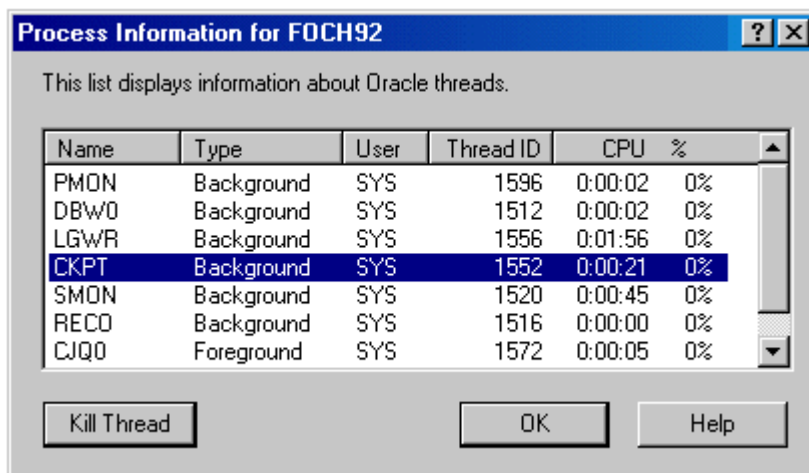

---

---

# Tuning Windows to Optimize Oracle Database

This chapter describes how to tune the Windows Server operating system to ensure that Oracle Database is running in the best possible environment.

This chapter contains these topics:

- [Windows Tuning Overview](#)
- [Large Page Support](#)
- [User Threads](#)
- [Reduce Priority of Foreground Applications on Server Console](#)
- [Configure Windows Server to Be an Application Server](#)
- [Disable Unnecessary Services](#)
- [Remove Unused Network Protocols](#)
- [Reset Network Protocol Bind Order](#)
- [Apply Latest Reliable Windows Server Service Pack](#)
- [Use Hardware or Operating System Striping](#)
- [Multiplex Windows Server Virtual Memory Paging File](#)
- [Close All Unnecessary Foreground Applications](#)

---

---

**Note:** For the sake of brevity, this discussion uses the collective term *Windows Server* when a statement applies to Windows 2000 Server and Windows NT Server.

---

---

## Windows Tuning Overview

Windows Server operating systems offer considerably fewer tuning adjustments than UNIX. This difference constrains systems administrators when they try to optimize Windows Server performance, but it also makes Windows Server easier to use.

There are still ways, however, to make Windows Server a better application server environment for Oracle Database. Most of the operating system specific procedures described in this chapter enable Oracle Database to reserve more system resources, such as CPU, memory, and disk I/O.

In addition, because Oracle Database is a high-performance database management system that effectively uses resources of your Windows computer, it should not also serve as any of the following:

- Primary or backup domain controller
- File or print server
- Remote access server
- Router

These configurations consume network, memory, and CPU resources. In addition, the Windows computer that is running Oracle Database should not be locally accessed with a high frequency or intensively used for local user processing, unless it has enough resources to accommodate all this activity.

---

---

**Note:** Information presented in this chapter does not apply to Oracle Database installations on Windows NT Workstation. It does apply to Oracle Database installations on Windows NT Server and Windows NT Server 4.0, Enterprise Edition. Windows NT Server 4.0, Enterprise Edition includes capability for using additional products. One such product is Microsoft Cluster Server, which is required to implement Oracle Fail Safe.

---

---

## Large Page Support

Large page support is a new feature of Oracle Database 10g. It provides a performance boost for memory-intensive database instances running on Windows Server 2003. By taking advantage of newly introduced operating system support, Oracle Database 10g can now make more efficient use of processor memory addressing resources. Specifically, when large page support is enabled, the CPUs in



the system will be able to access the Oracle Database buffers in RAM more quickly. Instead of addressing the buffers in 4KB increments, the CPUs are told to use 4MB page sizes when addressing the database buffers.

This feature is particularly useful when the Oracle buffer cache is several gigabytes. Smaller-sized configurations will still see a gain when using large pages, but the gain will not be as great as when the database is accessing large amounts of memory.

To enable large page support, set `ORA_LPENABLE` to 1 in the Oracle key of the Windows Server 2003 registry.

## User Threads

Oracle Database for Windows executes in a single process with multiple threads servicing user requests and background tasks. These threads are scheduled by the Windows operating system. In some circumstances, performance can be improved by running Oracle in user-thread mode. User threads are light-weight, application-scheduled threads, also referred to in Windows terminology as fibers. In user-thread mode, Oracle threads are scheduled not by the operating system, but by Oracle itself. Oracle can then use its knowledge about contention around shared resources to achieve more efficient and scalable thread scheduling.

## When to Use User-Thread Mode

User-thread mode should only be enabled as a means to improve the performance of an optimized Oracle Database. That is, you should first attempt to optimize the default configuration of Oracle Database for Windows as discussed elsewhere in this chapter.

User-thread mode gives performance gains only when an opportunity exists to improve the scheduling of Oracle threads. This situation typically occurs when an Oracle instance has fully utilized the CPU and is running a load that contains a high ratio of concurrent user requests to number of CPUs. Oracle wait events may provide clues that such opportunities exist.

**See Also:** *Oracle Database Performance Tuning Guide* for more information on Oracle wait events

Almost every wait event has a scheduling component. Each time a thread waits for a certain event, part of the wait time can be due to scheduling. Some of the scheduling delay may be mandatory. For example, if the system is heavily loaded,

then there will be scheduling delay because not all runnable threads can run on a given CPU at the same time. But some of the delay may be due to sub-optimal scheduling. By enabling user threads, you allow Oracle to optimize the scheduling of different tasks and therefore improve the average wait time of any wait event that has a non-mandatory scheduling component.

For example, the Oracle wait event `log file sync` measures the time it takes for an Oracle thread executing a user task to commit a transaction. This includes the time taken to actually write to the log file, measured by `log file parallel write`, and some scheduling delay. Even though the transaction is committed, the wait time continues to grow until the thread waiting for `log file sync` is allowed to run again. Therefore, one indicator that user threads should be used is if `log file sync` has a high average wait time and other wait events that are included in the `log file sync` wait time (for example, `log file parallel write`) have a low average wait time.

Another example is the Oracle wait event `free buffer waits`, which happens when the DBWR thread is unable to write out dirty buffers fast enough. One possible cause of this wait event is too-seldom scheduling of the DBWR background thread. By enabling user-threads, you give Oracle control over when the DBWR background thread is scheduled. Oracle can then schedule DBWR often enough to keep `free buffer waits` at a minimum.

---

---

**Note:** User-thread mode should be used only after other means of reducing `free buffer waits` have been exhausted. See *Oracle Database Performance Tuning Guide* for more information.

---

---

Other wait events with a scheduling component include `db file sequential read`, `db file parallel read`, and `db file scattered read`. Part of the measured time for these wait events is the actual time it takes for the I/O to complete. But during the remainder of the wait time a thread is waiting to be rescheduled. By looking at disk statistics, using tools like Windows Perfmon, you can find out what portion of wait time is I/O latency and what portion is scheduling delay. User-thread mode can help reduce the non-mandatory scheduling delay.

User-thread mode on Windows is not currently supported in the following configurations:

- Real Application Clusters
- Microsoft Transaction Server

- Oracle Data Mining
- Third party libraries used directly by Oracle

## Enabling User-Thread Mode

Follow this procedure to enable user-thread mode:

1. Shut down all instances.
2. Stop all Oracle services (both for the database and for the listener).
3. Exit any SQL\*Plus sessions.
4. Make sure that the ORACLE\_HOME environment variable is set.
5. Open a command prompt and enter `cd /d %ORACLE_HOME%\bin`
6. Run `enable_fibers.bat`

## Disabling User-Thread Mode

Follow this procedure to disable user-thread mode:

1. Shut down all instances.
2. Stop all Oracle services (both for the database and for the listener).
3. Exit any SQL\*Plus sessions.
4. Make sure that the ORACLE\_HOME environment variable is set.
5. Open a command prompt and enter `cd /d %ORACLE_HOME%\bin`
6. Run `disable_fibers.bat`

## Reduce Priority of Foreground Applications on Server Console

One of the settings provided by default during installation of Windows Server gives interactive foreground applications priority over every background **process**. To prevent foreground applications on the server console from taking excessive processor time away from Oracle Database, you can reduce priority for foreground applications.

**See Also:** Your Windows documentation for instructions on reducing priority of foreground applications

## Configure Windows Server to Be an Application Server

Windows memory manager divides up system memory into three different pools described in [Table 8-1](#).

**Table 8-1** *Windows Server Memory Shares*

Pool	Percent of Total Memory
Kernel and other system services	9%
File Cache	41%
Paged Memory	50%

Windows Server memory manager tries to balance each application's usage of memory by dynamically paging memory between physical RAM and a virtual memory paging file. If an application is particularly memory-intensive (like Oracle Database) or if a large number of applications are running concurrently, then combined memory requirements of the applications may exceed physical memory capacity.

The large proportion of memory reserved for file caching (41%) can be quite beneficial to file and print servers. But it may not be advantageous to application servers that often run memory-intensive network applications. A Windows Server file cache is particularly unnecessary for Oracle Database, which performs its own caching through [System Global Area](#).

You can reset the Windows Server memory model from the default file and print server, with its large file cache, to a network applications model, with a reduced file cache and more physical memory available for Oracle Database.

**See Also:** Your Windows documentation for instructions

## Disable Unnecessary Services

After you have significantly reduced the file cache as described in "[Configure Windows Server to Be an Application Server](#)" on page 8-6, you can retrieve additional physical memory for Oracle Database by disabling services not needed for core operating system functionality. Unnecessary services include:

- License Logging Service
- Plug and Play
- Remote Access Autodial Manager

- Remote Access Connection Manager
- Remote Access Server
- Telephony Service

Consult with your systems administrator to identify other unnecessary services.

Do *not* disable any of the following services:

- Alerter
- Computer Browser
- EventLog
- Messenger
- OracleServiceSID
- OracleHOME\_NAMETNSListener
- OracleStartSID (Oracle8 release 8.0.6 and earlier)
- Remote Procedure Call (RPC) Service
- Server
- Spooler
- TCP/IP NetBIOS Helper
- Workstation

**See Also:** Your Windows documentation for instructions on disabling unnecessary services

## Remove Unused Network Protocols

Remove all unnecessary network protocols on Windows so that processing time can be concentrated on servicing only critical protocols.

**See Also:** Your Windows documentation for instructions on removing unnecessary network protocols

## Reset Network Protocol Bind Order

If multiple protocols must be installed on the server, you can give the protocol most frequently used by Oracle Database highest priority by resetting the network protocol bind order.

**See Also:** Your Windows documentation for instructions on resetting network protocol bind order

## Apply Latest Reliable Windows Server Service Pack

Microsoft releases operating system patches, called Service Packs, on a quarterly basis. Service Packs are collections of bug fixes and product enhancements to the basic Windows Server release. In general, apply Service Packs as soon as it is safe to do so, since they fix bugs and can improve Windows Server performance or functionality.

While Service Packs are supposed to fix bugs, there have been reports (for example, the initial release of Windows NT Server 4.0 Service Pack 2) of bugs within the patch updates themselves. In general, it is safest to wait a few weeks after a Service Pack is released before implementing it. This allows time for other field sites to report any problems with the SP release.

The latest Windows Server Service Packs may be downloaded as self-extracting archives from <http://support.microsoft.com>

Unless there are assurances that the Service Pack works without flaws on Windows Server, choose to create an `Uninstall` directory. This enables the Service Pack to be removed and the original configuration to be restored.

Service Pack files overwrite similarly-named files in the previous Windows Server configuration. However, Service Pack files can be overwritten in turn by setup programs that copy files from the original installation media.

For example, installing a new network protocol or printer driver usually requires copying files from original Windows Server installation media. When Service Pack files are comprehensively or selectively overwritten, the Service Pack must be re-applied.

## Use Hardware or Operating System Striping

Compared to CPU and memory speeds, hard disk drives are extremely slow. Now that hard disk drives are relatively inexpensive, Oracle recommends that Windows Server use logical volumes comprised of striped physical disks. Data striping is an

effective means of reducing the impact of relatively slow hard drives by distributing file I/O across a number of hard drives simultaneously.

Striping data across a number of disks is one example of a redundant array of inexpensive disks (RAID). There are several different types of RAID, also referred to as RAID levels, ranging from high performance to high reliability. The three most common RAID levels in Oracle Database installations are RAID-0, RAID-1, and RAID-5. Descriptions of each RAID level follow [Table 8–2](#), which shows each level's read and write penalties.

**Table 8–2 RAID Levels in Oracle Database Installations**

RAID Level	Read Penalty <sup>1</sup>	Write Penalty <sup>2</sup>
0 (Disk Striping)	1:1	1:1
1 (Disk Mirroring)	1:1	2:1
0 + 1	1:1	2:1
5 (Distributed Data Gathering)	1:1	4:1

<sup>1</sup> Read penalty is ratio of I/O operations to read requests.

<sup>2</sup> Write penalty is ratio of I/O operations to write requests.

## Disk Striping

RAID level 0 enables high-performance, fault-intolerant disk striping. Multiple physical hard disks are aggregated into a logical whole, either by a disk controller or through the operating system (for example, Windows 2000 Server striped volumes). Data operations against the logical volume are broken down into as many chunks as there are physical drives in the array, making simultaneous use of all disks. Given identical hard disks, if one hard disk has a throughput rate of DISKRATE operations/second, then a RAID 0 logical volume has a rate of:

$(\text{DISKRATE} * [\text{number of physical drives in array}]) \text{ operations/second}$

The downside of RAID 0 is its lack of fault tolerance. If one disk in the logical volume fails, the whole volume fails and must be restored from a [backup](#).

## Disk Mirroring

RAID level 1 enables fault tolerant disk mirroring with some chance of a performance penalty. Essentially, every write to a mirrored disk is duplicated on another drive dedicated to this purpose (the mirror drive). If the mirrored disk fails, the mirror drive is brought online in real time. After the faulted drive is replaced, the mirror configuration can be reestablished.

The read penalty for RAID level 1 is nominally 1:1, but it may benefit from split reads on some controllers. When the controller knows which mirror can be accessed fastest, for example, it can lower seek times by directing I/O operations to that disk.

### **Disk Striping + Mirroring**

RAID level 0+1 enables mirroring of an array of striped hard disks. This is a blend of RAID 0 and RAID 1, offering high-performing fault tolerance.

### **Distributed Data Guarding**

RAID level 5, also known as disk striping with parity, eliminates the costly requirement to mirror. In RAID 5, multiple hard disks are aggregated into a striped logical volume, similar to RAID 0, but each drive contains parity information such that any single drive failure is tolerated. With one failed drive, a RAID-5 system can allow continued access to data, although access times are greatly reduced due to on-the-fly rebuilding of bytes from parity information. RAID-5 solutions usually allow hot-swapping of faulty drives with replacements, triggering a rebuild of the failed drive's data onto the replacement from parity information.

The write penalty of 4:1 results from 2 reads and 2 writes during parity calculation.

## **Multiple Striped Volumes for Sequential and Random Access**

If there are enough physical disks in Windows Server, create at least two striped volumes (in addition to a standalone hard disk or striped volume for the operating system). One striped volume can be used for sequential data access, and the other can be used for random data access.

Oracle Database redo logs and archived redo logs, for example, are written in sequential order. Because of reduced head movement, hard disks perform best when reading or writing sequential data.

Oracle Database data files, however, are usually accessed in random order. Random access in a hard disk results in significant head movement, translating to slower data access.

Unless redo logs are separated from datafiles (at physical device level), undo file I/O contention may result, increasing access times for both types of files.



## Multiplex Windows Server Virtual Memory Paging File

Some virtual memory paging is likely even if Oracle Database is the only network application running on Windows Server, because Windows Server memory manager will attempt to move seldom-used pages to disk to free up more physical memory for hot pages.

Multiplexing the Windows Server virtual memory paging file is a good strategy to boost overall system performance. Splitting the paging file onto at least two different physical volumes (or logical volumes as long as underlying physical volumes do not overlap) provides a significant performance boost to virtual memory swapping operations.

Even though this is a good technique to increase speed of virtual memory paging, too much paging activity is still a performance hit and should be corrected by adding more RAM to the server.

### General Page File Sizing Tip

Oracle recommends that total combined size of your page files be at least equal to physical RAM on your computer. Configurations where combined size is two to four times the size of physical RAM are not uncommon. Minimize paging as much as possible. But situations in which the operating system runs out of or low on paging space are to be avoided at all costs. Adequately-sized paging files spaced across physical disks spread out I/O most efficiently, because the operating system spreads paging evenly across page files.

---

---

**Note:** Internal read/write batch size for Windows is 4K.

---

---

## Close All Unnecessary Foreground Applications

Once procedures in previous sections have been applied, remember to close any unnecessary foreground applications. First, remove all applications from Startup folders of Windows Server console operators. Second, minimize the window when executing long-running scripts from a command prompt, so that Windows Server can focus on the operation and not on a flood of window repaint messages. Third, disable screen savers, which can quickly saturate the CPU. If a screen saver must be run, choose Blank Screen, which uses the least amount of processing time.



---

---

# Authenticating Database Users with Windows

This chapter describes authentication of Oracle Database users with Windows operating systems.

This chapter contains these topics:

- [Windows Native Authentication Overview](#)
- [Windows Authentication Protocols](#)
- [User Authentication and Role Authorization Methods](#)
- [Operating System Authentication Enabled at Installation](#)

## Windows Native Authentication Overview

Oracle Database can use Windows user login **credentials** to **authenticate** database users. Benefits include:

- Enabling users to connect to Oracle Database without supplying a **username** or password
- Centralizing Oracle Database user authentication and role **authorization** information in Windows NT or Windows 2000, which frees Oracle Database from storing or managing user passwords or **role** information

The Windows native authentication adapter (automatically installed with **Oracle Net Services**) enables database user authentication through Windows. This enables client computers to make secure connections to Oracle Database on a Windows server. The server then permits the user to perform database actions on the server.

---

---

**Note:** Current user database links are not supported with Windows native authentication.

---

---

---

---

**Note:** This chapter describes using Windows native authentication methods with Windows 2000 and Windows NT 4.0. For information on Secure Sockets Layer (SSL) protocol and Oracle Internet Directory, see *Oracle Advanced Security Administrator's Guide* and *Oracle Internet Directory Administrator's Guide*.

---

---

## Windows Authentication Protocols

The Windows native authentication adapter works with Windows authentication protocols to enable access to Oracle Database.

- Kerberos is the default authentication protocol for Windows 2000.
- NT LAN Manager (NTLM) is the default protocol for Windows NT 4.0.

If the user is logged on as a Windows 2000 domain user from a Windows 2000 computer, then Kerberos is the authentication mechanism used by the NTS adapter.

For all other users, NTLM is the authentication mechanism used by the NTS adapter.

If authentication is set to NTS on a standalone Windows 2000 or Windows NT 4.0 computer, ensure that Windows service NT LM Security Support Provider is

started. If this service is not started on a standalone Windows 2000 or Windows NT 4.0 computer, then NTS authentication fails. This issue is applicable only if you are running Windows 2000 or Windows NT 4.0 in standalone mode.

Client computers do not need to specify an authentication protocol when attempting a connection to Oracle Database. Instead, Oracle Database determines the protocol to use, completely transparent to the user. The only Oracle Database requirement is to ensure that parameter `SQLNET.AUTHENTICATION_SERVICES` contains `nts` in the following file on both the client and database server:

```
ORACLE_BASE\ORACLE_HOME\network\admin\sqlnet.ora
```

This is the default setting for both after installation. For Oracle8 release 8.0.x releases, you must manually set this value.

If typical, your Oracle Database network includes client computers and database servers, and computers on this network may use different Oracle Database software releases on different Windows operating systems on different domains. This combination of different releases means that the authentication protocol being used can vary.

[Table 9–1](#) lists Oracle Database software and Windows operating system releases required to enable Kerberos as the default authentication protocol:

**Table 9–1 Software Requirements to Enable Kerberos Authentication Protocol**

Location	Windows Software	Oracle Database Software
Client Computer	Windows NT 4.0 or Windows 2000	Oracle8i Client or later
Database Computer	Windows NT 4.0 or Windows 2000	Oracle8i Database or later
Domain	Windows 2000	None

For *all* other combinations of Windows operating system and Oracle Database software releases used in your network, the authentication protocol used is NTLM.

**See Also:** Microsoft Windows documentation for more information on each authentication protocol

## User Authentication and Role Authorization Methods

This section describes how user login credentials are authenticated and database roles are authorized in Windows NT 4.0 or Windows 2000 domains. User authentication and role authorization are defined in [Table 9–2](#).

**Table 9–2 User Authentication and Role Authorization Defined**

Feature	Description	More Information
User authentication	Process by which the database uses the user's Windows login credentials to authenticate the user.	<i>Oracle 2 Day DBA</i>
Role <b>authorization</b>	Process of granting an assigned set of roles to authenticated users.	<i>Oracle 2 Day DBA</i>

Oracle Database supports user authentication and role authorization in Windows NT 4.0 domains. [Table 9–3](#) provides descriptions of these basic features.

**Table 9–3 Basic Features of User Authentication and Role Authorization**

Feature	Description
Authentication of external users	Users are authenticated by the database using the user's Windows login credentials enabling them to access Oracle Database without being prompted for additional login credentials.
Authorization of external roles	Roles are authorized using <b>Windows local groups</b> . Once an <b>external role</b> is created, you can grant or revoke that role to a database user. Initialization parameter <code>OS_ROLES</code> is set to <code>false</code> by default. You must set <code>OS_ROLES</code> to <code>true</code> to authorize external roles.

## Authentication and Authorization Methods To Use

Table 12–4 describes user authentication and role authorization methods to use based on your Oracle Database environment:

**Table 9–4 User Authentication and Role Authorization Methods**

Method	Database Environment
Enterprise users and roles	<p>You have many users connecting to multiple databases.</p> <p>Enterprise users have the same identity across multiple databases. Enterprise users require use of a directory server.</p> <p>Use enterprise roles in environments where enterprise users assigned to these roles are located in many geographic regions and must access multiple databases. Each enterprise role can be assigned to more than one enterprise user in the directory. If you do not use enterprise roles, then you have to assign database roles manually to each database user. Enterprise roles require use of a directory server.</p>

**Table 9–4 User Authentication and Role Authorization Methods**

Method	Database Environment
External users and roles	<p>You have a smaller number of users accessing a limited number of databases. External users must be created individually in each database and do not require use of a directory server.</p> <p>External roles must also be created individually in each database, and do not require use of a directory server. External roles are authorized using group membership of the users in <b>local groups</b> on the system.</p>

**See Also:** *Oracle Advanced Security Administrator's Guide* for more information on Enterprise users and roles

## Operating System Authentication Enabled at Installation

When you install Oracle Database, a special Windows local group called `ORA_DBA` is created (if it does not already exist from an earlier Oracle Database installation), and your Windows username is automatically added to it. Members of local group `ORA_DBA` automatically receive the **SYSDBA privilege**.

Membership in `ORA_DBA` enables you to:

- Connect to local instances of Oracle Database without a password with the command
 

```
CONNECT / AS SYSDBA
```
- Connect to remote instances of Oracle Database without a password with the command
 

```
CONNECT /@net_service_name AS SYSDBA
```

where `net_service_name` is the **net service name** of the remote instance of Oracle Database
- Perform database administration procedures such as starting and shutting down local databases
- Add additional Windows users to `ORA_DBA`, enabling them to have the `SYSDBA` privilege





---

---

## Administering External Users and Roles on Windows

External users and roles are in general defined by something external to Oracle Database. In a Windows environment, they are defined by the operating system.

This chapter describes **external user** and **external role** creation and management using either Oracle Administration Assistant for Windows or by a combination of Oracle Database command line tools, Registry Editor, and other Windows tools.

---

---

**Note:** Both methods can also administer external users and roles in Windows 2000 domains, but cannot be used to administer an **enterprise user** or an **enterprise role**. See *Oracle Advanced Security Administrator's Guide* for more information on tools available for administering enterprise users and roles.

---

---

This chapter contains these topics:

- [Oracle Administration Assistant for Windows](#)
- [Manually Administering External Users and Roles](#)

## Oracle Administration Assistant for Windows

Oracle Administration Assistant for Windows runs from [Microsoft Management Console](#) and enables you to configure the following Oracle Database users and roles so that the Windows operating system can [authenticate](#) them, and they can access Oracle Database without a password:

- Regular Windows domain users and [global groups](#) as external users
- Windows database administrators (with the [SYSDBA privilege](#))
- Windows database operators (with the [SYSOPER](#) privilege)

In addition, Oracle Administration Assistant for Windows can create and grant local and external database roles to Windows domain users and global groups.

With Oracle Administration Assistant for Windows, none of the following need be done manually:

- Create [local groups](#) that match the database [system identifier](#) and [role](#)
- Assign domain users to these local groups
- Authenticate users in SQL\*Plus with `CREATE USER username IDENTIFIED EXTERNALLY`

This section describes how to perform the following tasks with Oracle Administration Assistant for Windows:

- [Adding a Computer and Saving Your Configuration](#)
- [Granting Administrator Privileges for All Databases on a Computer](#)
- [Granting Operator Privileges for All Databases on a Computer](#)
- [Connecting to a Database](#)
- [Viewing Database Authentication Parameter Settings](#)
- [Creating an External Operating System User](#)
- [Creating a Local Database Role](#)
- [Creating an External Operating System Role](#)
- [Granting Administrator Privileges for a Single Database](#)
- [Granting Operator Privileges for a Single Database](#)

---



---

**Note:** Oracle Administration Assistant for Windows runs from Microsoft Management Console, which is automatically included in Windows 2000. If you are using Windows NT 4.0, you must do one of the following:

- Install Microsoft Windows NT 4.0 Option Pack, which includes Microsoft Management Console
  - Download Microsoft Management Console from the Microsoft Web site: <http://www.microsoft.com>
- 
- 

## Managing a Remote Computer

If you want to use Oracle Administration Assistant for Windows to manage a **remote computer**, you must have administrator privileges for the remote computer. Oracle Administration Assistant for Windows always creates users in Oracle Database with the domain name as the prefix. If you are managing Oracle7 release 7.x or later databases remotely, you must set registry parameter `OSAUTH_PREFIX_DOMAIN` to `true` on the remote computer. This parameter is located in

```
HKEY_LOCAL_MACHINE\SOFTWARE\ORACLE\KEY_HOME_NAME
```

If a Windows 2000 computer is not identified with a Domain Name System (DNS) domain name, you will receive the following error message:

```
Calling query w32RegQueries1.7.0.17.0 RegGetValue
Key = HKEY_LOCAL_MACHINE
SubKey = SYSTEM\CurrentControlSet\Services\Tcpip\Parameters
Value = Domain
Query Exception: GetValueKeyNotFoundException
Query Exception Class: class oracle.sysman.oii.oii.OiiQueryException
...
```

To assign a DNS name:

1. Choose **Start > Settings > Control Panel > System > Network Identification > Property > More > Primary DNS**.
2. Enter a domain name, such as `US.ORACLE.COM`.

## Adding a Computer and Saving Your Configuration

When you use Oracle Administration Assistant for Windows for the first time, it adds the local computer to its navigation tree. You can then add other computers.

To add a computer to the Microsoft Management Console tree:

1. Choose **Start > Programs > Oracle - HOME\_NAME > Configuration and Migration Tools > Administration Assistant for Windows**.

Microsoft Management Console starts.

2. Double-click **Oracle Managed Objects**.

The Computer icon appears.

3. Right-click **Computers**.

4. Choose **New > Computer**.

The Add Computer dialog appears.

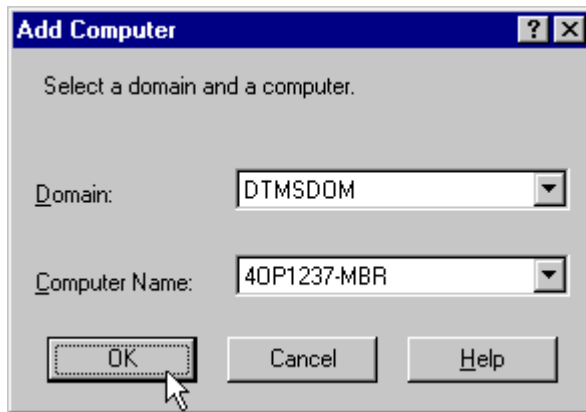

5. Specify the domain and computer name for the computer on which Oracle Database is installed.
6. Click **OK**.
7. Double-click **Computers** to display the computer you added.
8. Double-click the computer you added. Several nodes for authenticating database administrators and operators appear.

The **OS Database Administrators - Computer** node creates an operating system-authenticated database administrator with `SYSDBA` privileges for every database **instance** on the computer. The **OS Database Operators - Computer** node creates an operating system-authenticated database operator with `SYSOPER` privileges for every database instance on the computer.

9. Save your configuration in a console file by choosing **Save** in the Console main menu. You can now authenticate database administrators and operators for all instances on the computer.

## Granting Administrator Privileges for All Databases on a Computer

To grant database administrator (`SYSDBA`) privileges to database administrators (DBAs) for *all* databases on a computer:

1. Choose **Start > Programs > Oracle - HOME\_NAME > Configuration and Migration Tools > Administration Assistant for Windows**.

Oracle Administration Assistant for Windows starts.

2. Right-click **OS Database Administrators - Computer**.
3. Click **Add/Remove**.

The OS Database Administrators - Computer for *hostname* dialog appears.

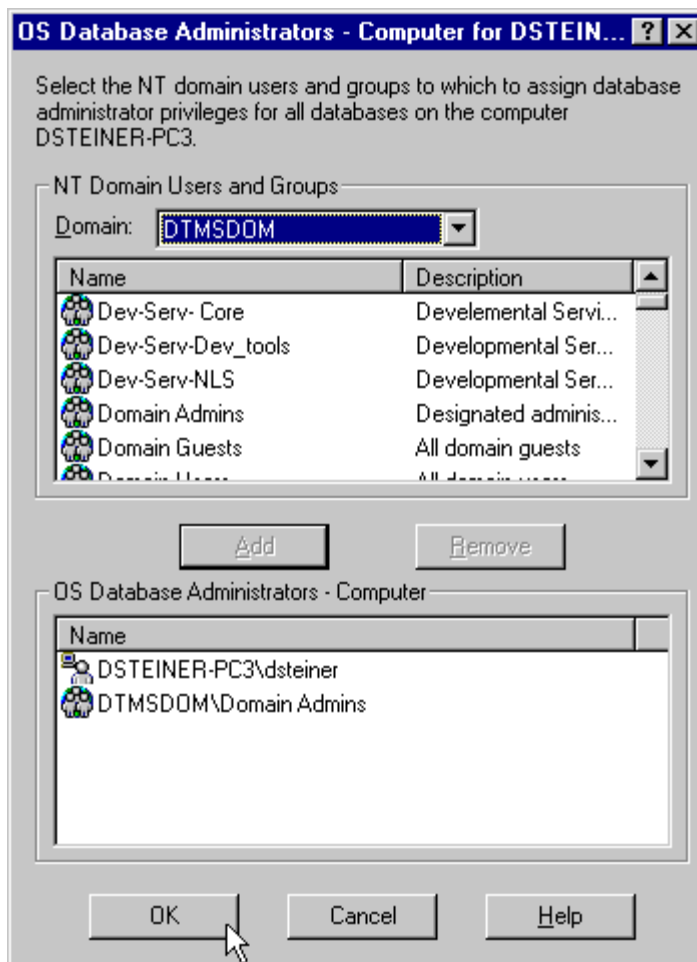

4. Select the domain of the user to which to grant SYSDBA privileges from the **Domain** list.
5. Select the user.
6. Click **Add**.  
The user now appears in the OS Database Administrators - Computer window.
7. Click **OK**.

## Granting Operator Privileges for All Databases on a Computer

To grant database operator (SYSOPER) privileges to DBAs for *all* databases on a computer:

1. Choose **Start > Programs > Oracle - HOME\_NAME > Configuration and Migration Tools > Administration Assistant for Windows**.

Oracle Administration Assistant for Windows starts.

2. Right-click **OS Database Operators - Computer**.
3. Click **Add/Remove**.

The OS Database Operators - Computer for *hostname* dialog appears.

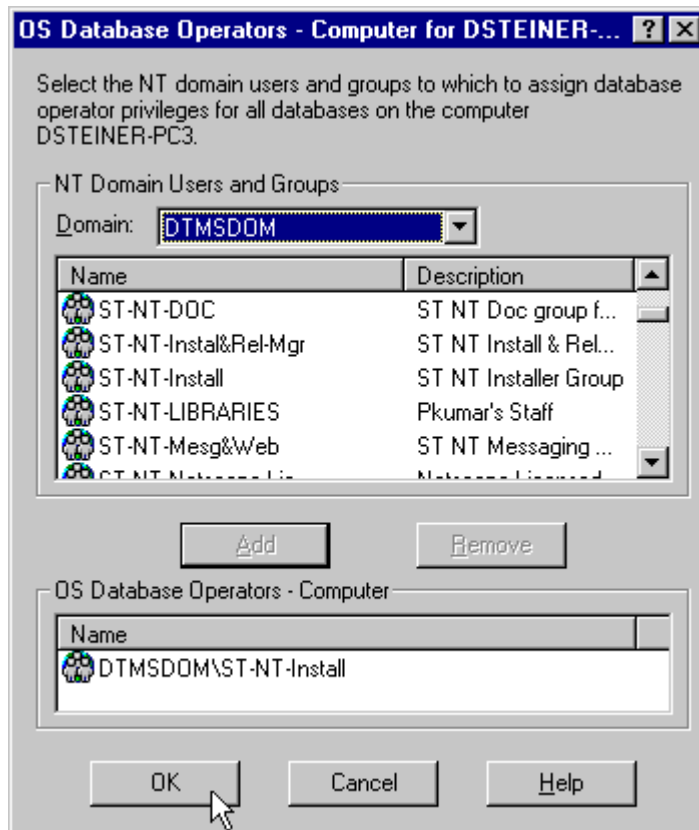

4. Select the domain of the user to which to grant `SYSOPER` privileges from the Domain list.
5. Select the user.
6. Click **Add**.  
The user now appears in the OS Database Operators - Computer window.
7. Click **OK**.

## Connecting to a Database

To enable Secure Sockets Layer (SSL) when connecting to Oracle Database, start the Oracle Database service and the **listener** service in the same user account as the wallet created in Oracle Wallet Manager. Do not use the default user account in the Windows Services dialog. If the Oracle Database service and the listener service are started in the default user accounts, then SSL does not work, and the listener does not start. Support for SSL is an Oracle Advanced Security feature. Oracle Wallet Manager is also an Oracle Advanced Security feature.

**See Also:** *Oracle Advanced Security Administrator's Guide* for more information on SSL support

To connect to a database:

1. Right-click the database instance you want to access in the Microsoft Management Console scope pane. In the example here, a connection is to be made to `ORCL`:



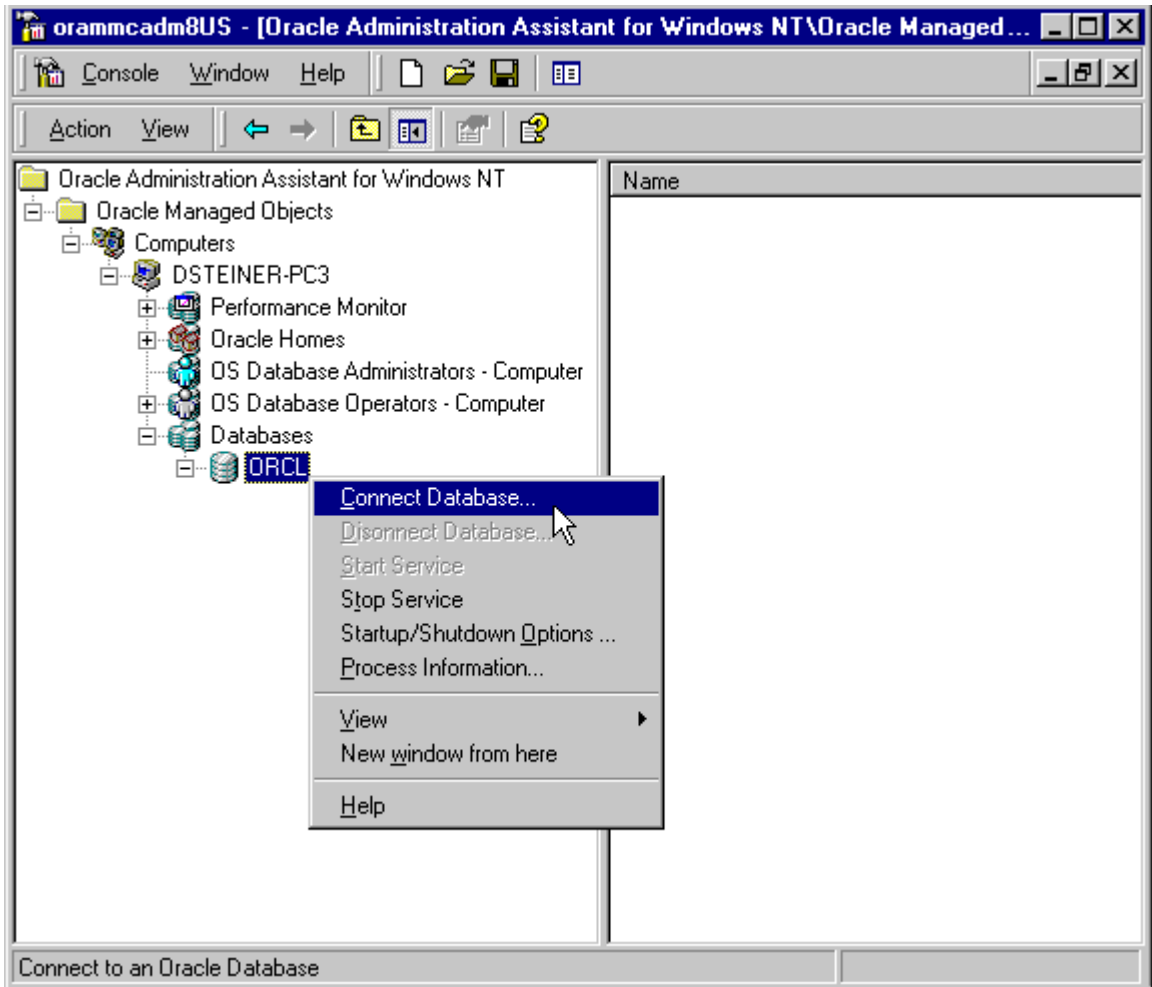

2. Choose **Connect Database**.

If you connect to Oracle Database, the following Windows nodes appear beneath the instance. If these nodes do not appear, double-click the instance.

- External OS Users
- Local Roles
- External OS Roles

- OS Database Administrators
- OS Database Operators

### Troubleshooting Connection Problems

When connecting to a local computer, Oracle Administration Assistant for Windows first tries to connect to the database as a SYSDBA, using the Bequeath networking protocol. When connecting to a remote computer, Oracle Administration Assistant for Windows first tries to connect to the database using Windows native authentication as a SYSDBA, using the TCP/IP networking protocol (port 1521 or the deprecated 1526). If it is unsuccessful, one or more dialogs appear and prompt you to enter information to connect to the database.

The dialog shown here appears because the Windows domain user with which you are attempting to connect to Oracle Database is not recognized as an authenticated user with SYSDBA privileges. Enter an Oracle Database **username** and password to access the database. To avoid being prompted with this dialog again, configure your domain user to be a database administrator authenticated by the Windows operating system.

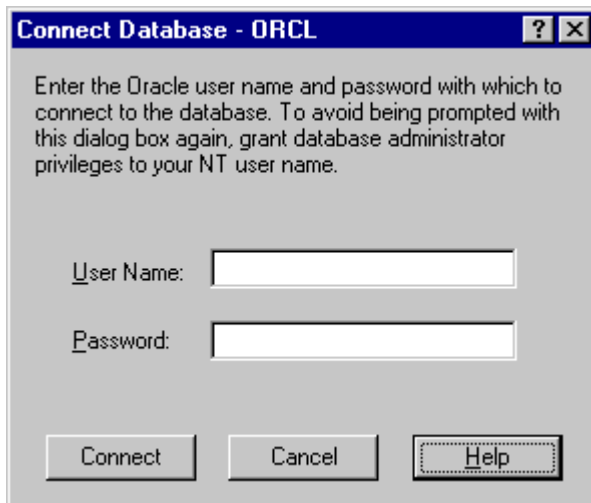

The next dialog appears either because you are not using the TCP/IP networking protocol to connect to a remote installation of Oracle Database or because Oracle Database is not running. Using a protocol other than TCP/IP (Named Pipes for example) causes this dialog to appear each time you attempt a remote connection.

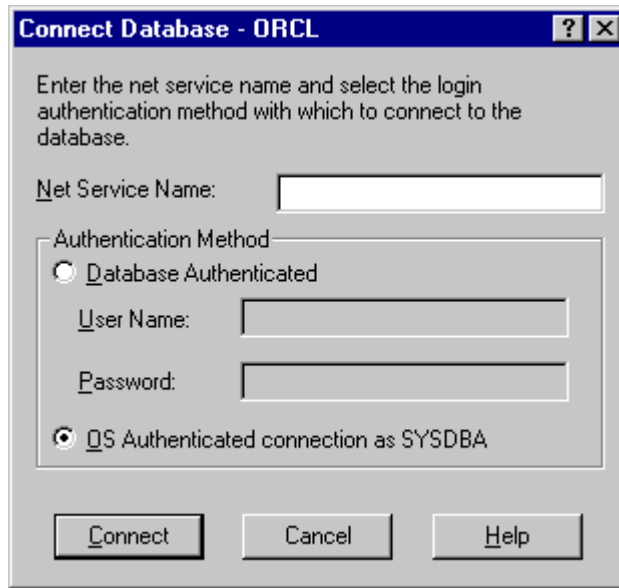

If you do not want this dialog to appear each time, then change to the TCP/IP protocol and make sure the **Oracle Net Services** listener for the database is listening on the default port 1521 (or the deprecated default port 1526). Otherwise, this dialog appears every time. Ensure also that Oracle Database is started.

1. Enter the **net service name** with which to connect to Oracle Database. You must enter a net service name regardless of the authentication method you select.
2. If you want to access the database with an Oracle Database username and password, select the Database Authenticated option. This username and password must exist in Oracle Database and have the SYSDBA privilege.
3. If you want to access the database with the Windows domain user with which you are currently logged in, select the OS Authenticated Connection as SYSDBA option. This domain user must already be recognized by Windows as an authenticated user with SYSDBA privileges. Otherwise, your logon fails.

---

**Note:** Oracle Net Services provides a Trace Assistant tool that helps diagnose connection problems by converting existing trace file text into a more readable format. See "Using the Trace Assistant to Examine Trace Files" in *Oracle Net Services Administrator's Guide*.

---

## Viewing Database Authentication Parameter Settings

To view database authentication parameter settings:

1. Right-click the database.
2. Choose **Properties**.
3. The Properties dialog appears displaying the following parameter values:
  - OS\_AUTHENT\_PREFIX
  - OS\_ROLES

OS\_AUTHENT\_PREFIX is an `init.ora` file parameter that authenticates external users attempting to connect to Oracle Database with the user's Windows username and password. The value of this parameter is attached to the beginning of every user's Windows username.

By default, the parameter is set to none ("" ) during Oracle Database creation. Therefore, a Windows domain username of `frank` is authenticated as username `frank`. If you set this parameter to `xyz`, then Windows domain user `frank` is authenticated as user `xyzfrank`.

OS\_ROLES is an `init.ora` file parameter that, if set to `true`, enables the Windows operating system to manage **authorization** of an **external role** for a database user. By default, OS\_ROLES is set to `false`. You must set OS\_ROLES to `true` and restart Oracle Database before you can create external roles. If OS\_ROLES is set to `false`, Oracle Database manages granting and revoking of roles for database users.

If OS\_ROLES is set to `true`, and you assign an external role to a Windows global group, then it is granted only at the Windows global group level, and not at the level of the individual user in this global group. This means that you cannot revoke or edit the external role assigned to an individual user in this global group through the Roles tab of the User Name Properties dialog at a later time. Instead, you must use the field in the Assign External OS Roles to a Global Group dialog to revoke the external role from this global group (and therefore all its individual users).

External roles assigned to an individual domain user or **local roles** (with OS\_ROLES set to `false`) assigned to an individual domain user or Windows global group are not affected by this issue. They can be edited or revoked.

If OS\_ROLES is set to `true`, you cannot grant local roles in the database to any database user. You must grant roles through Windows. See "[Creating a Local Database Role](#)" on page 10-23 and "[Creating an External Operating System Role](#)" on page 10-29 for more information.

## Creating an External Operating System User

The External OS Users node of Oracle Administration Assistant for Windows enables you to authenticate a Windows user to access Oracle Database as an external user without being prompted for a password. External users are typically regular database users (not database administrators) to which you assign standard database roles (such as CONNECT and RESOURCE), but do not want to assign SYSDBA (database administrator) or SYSOPER (database operator) privileges.

To create an external operating system user:

1. Follow the steps in "[Connecting to a Database](#)" on page 10-9 to connect to a database.
2. Right-click **External OS Users**. A contextual menu appears.

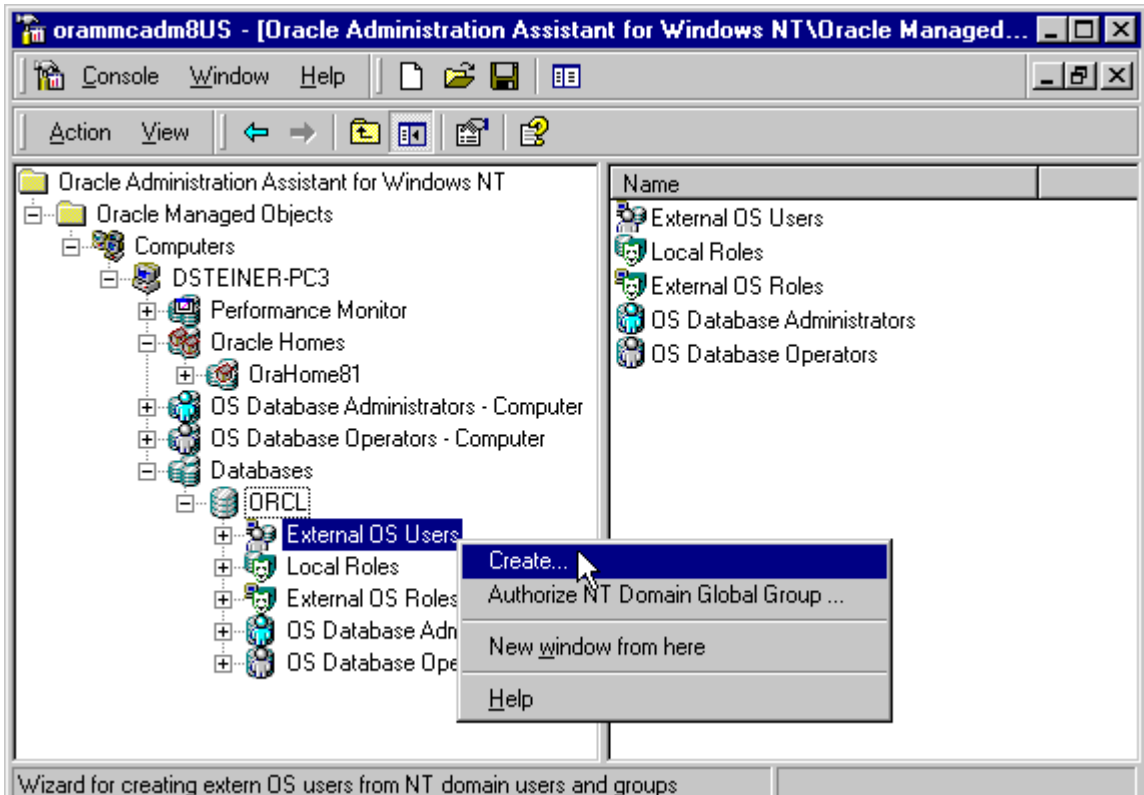

3. Choose **Create**.

Create External OS User Wizard starts, and the first of three wizard dialogs appears. The first dialog is for Windows Users and Groups.

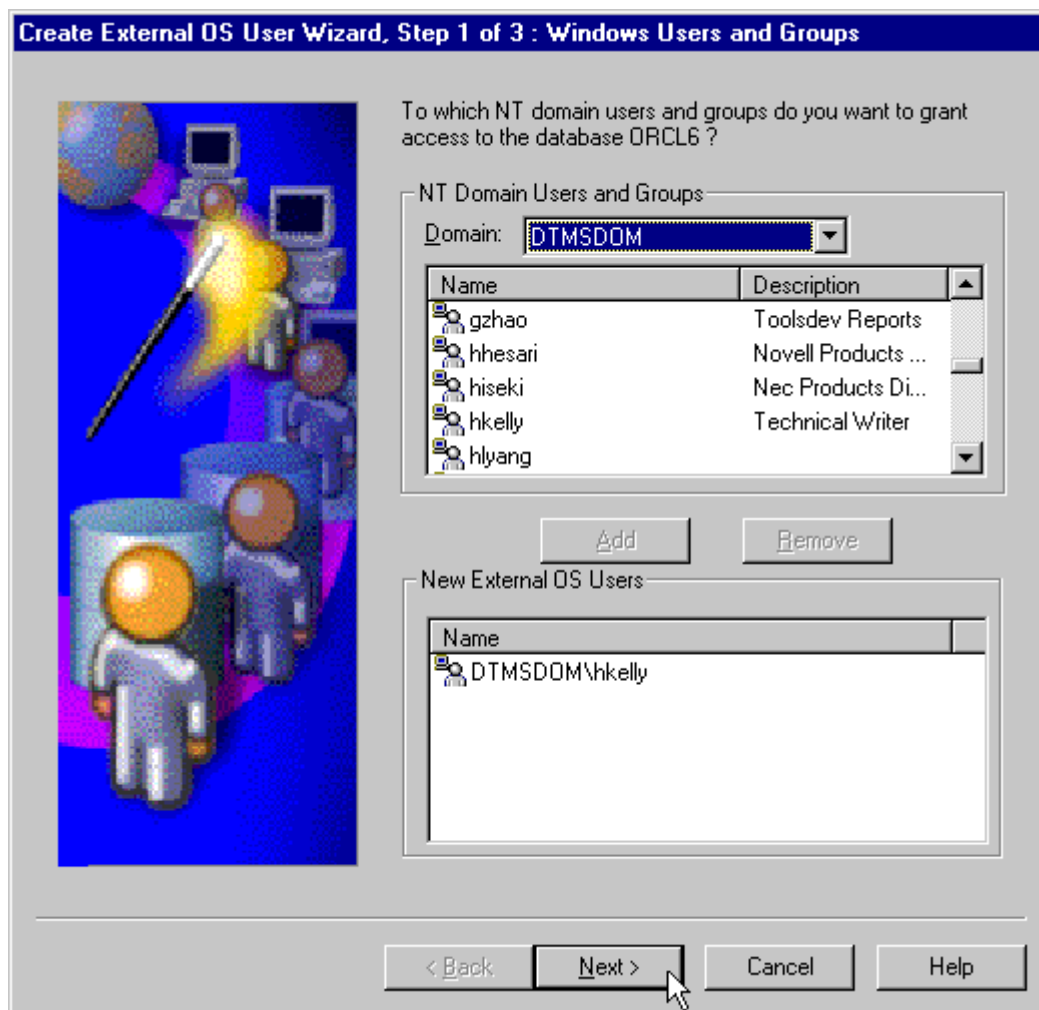

4. In **Domain Users and Groups** select the domain in which your Windows domain users and global groups are located.
5. Select the Windows domain users and global groups to which to grant access to the database.

6. Click **Add**. The selected users and groups now appear in the New External OS Users list.
7. Click **Next**. The Profile and Tablespace dialog appears.

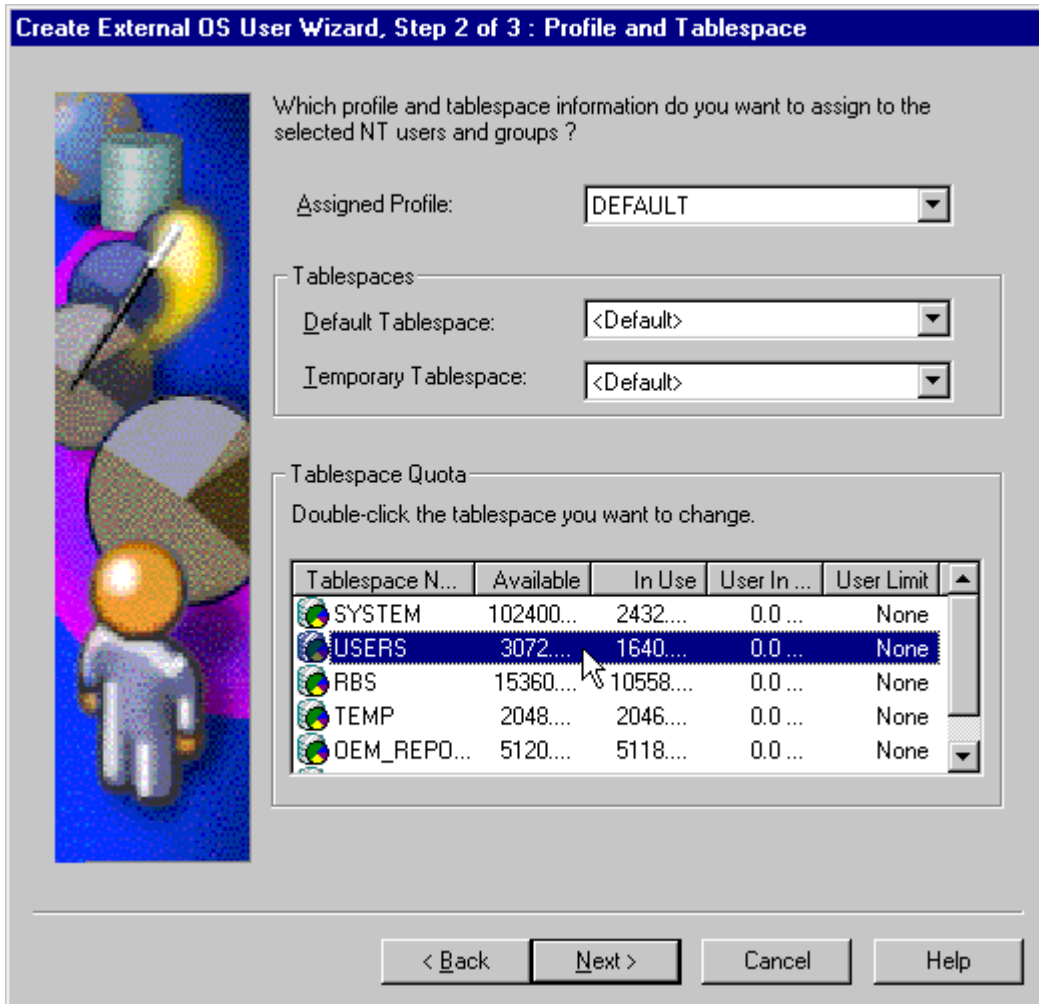

8. In the **Assigned Profile** list, select a profile for the new external users. A profile is a named set of resource limits. If resource limits are enabled, Oracle Database limits database usage and instance resources to whatever is defined in the user's

profile. You can assign a profile to each user and a default profile to all users who do not have specific profiles.

9. In **Tablespace Quota** double-click the **tablespace** to assign a tablespace **quota**.
10. Click **Next**. The Roles dialog appears.

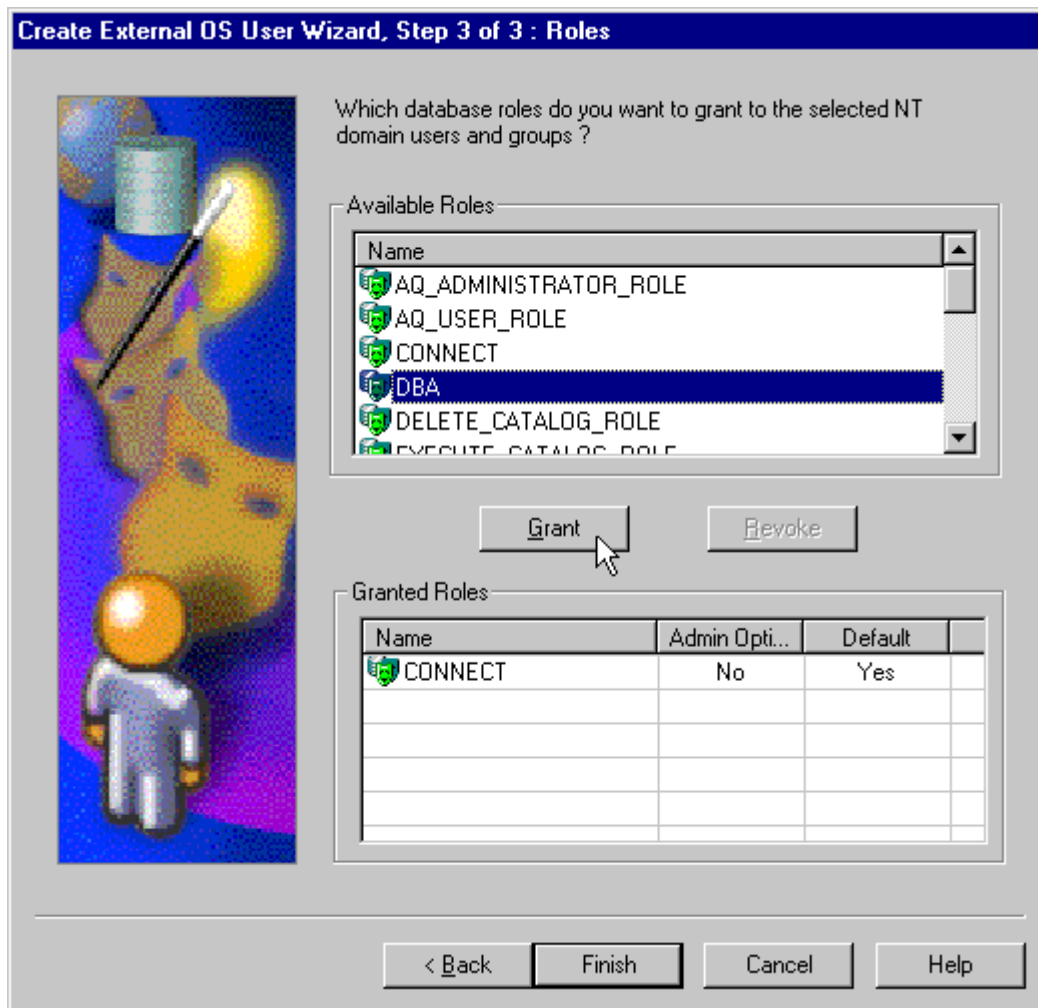

11. In **Available Roles** select the database roles to grant to the new external users.
12. Click **Grant**.



13. Click **Finish**.
14. Right-click the external user for which you want to view information and select **Properties**.

The assigned properties appear.

---

---

**Note:** If you select a Windows global group for authentication when using Oracle Administration Assistant for Windows, all users currently in the group are added to Oracle Database. If at a later time, you use a Windows tool to add or remove users in this Windows global group, these updates are not reflected in Oracle Database. The newly added or removed users must be explicitly added or removed in Oracle Database with Oracle Administration Assistant for Windows.

---

---

## Creating a Local Database Role

The Local Roles node of Oracle Administration Assistant for Windows enables you to create a role and have it managed by the database. Once a local role is created, you can grant or revoke that role to a database user. To create a local database role:

1. Follow the steps in "[Connecting to a Database](#)" on page 10-9 to connect to a database.
2. Right-click **Local Roles** for the database for which you want to create a local role.
3. Choose **Create**.

Create Local Role Wizard starts, and the first of three wizard dialogs appears. The first dialog is for Name and Authentication.

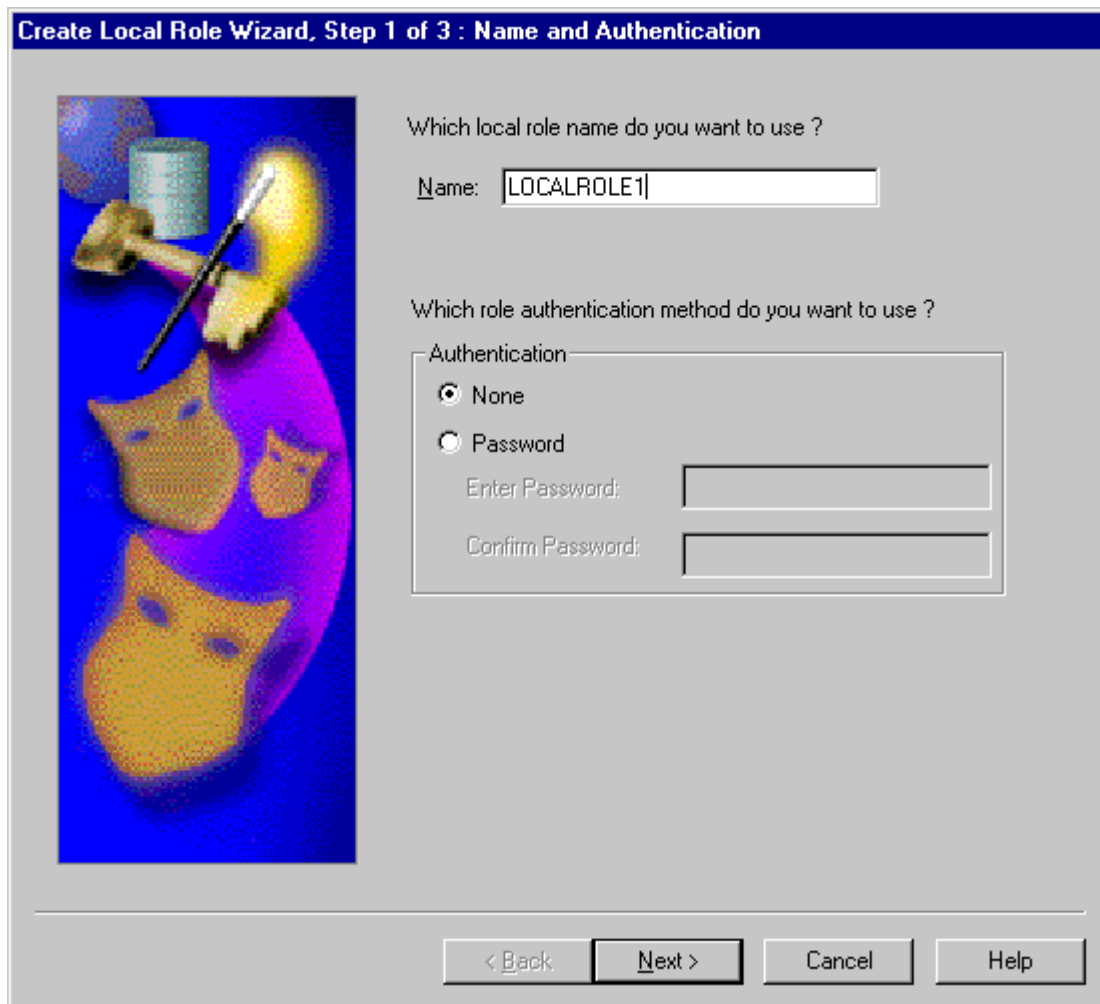

4. Enter a local role name to use.
5. In **Authentication** select **None** if you want a user to use this local role without being required to enter a password.

Select **Password** if you want use of this role to be protected by a password. These roles can only be used by supplying an associated password with the `SET ROLE` command. See *Oracle 2 Day DBA* for additional information.

Enter the password to use with this role.

Confirm the password by entering it a second time.

6. Click **Next**. The System Privileges dialog appears.

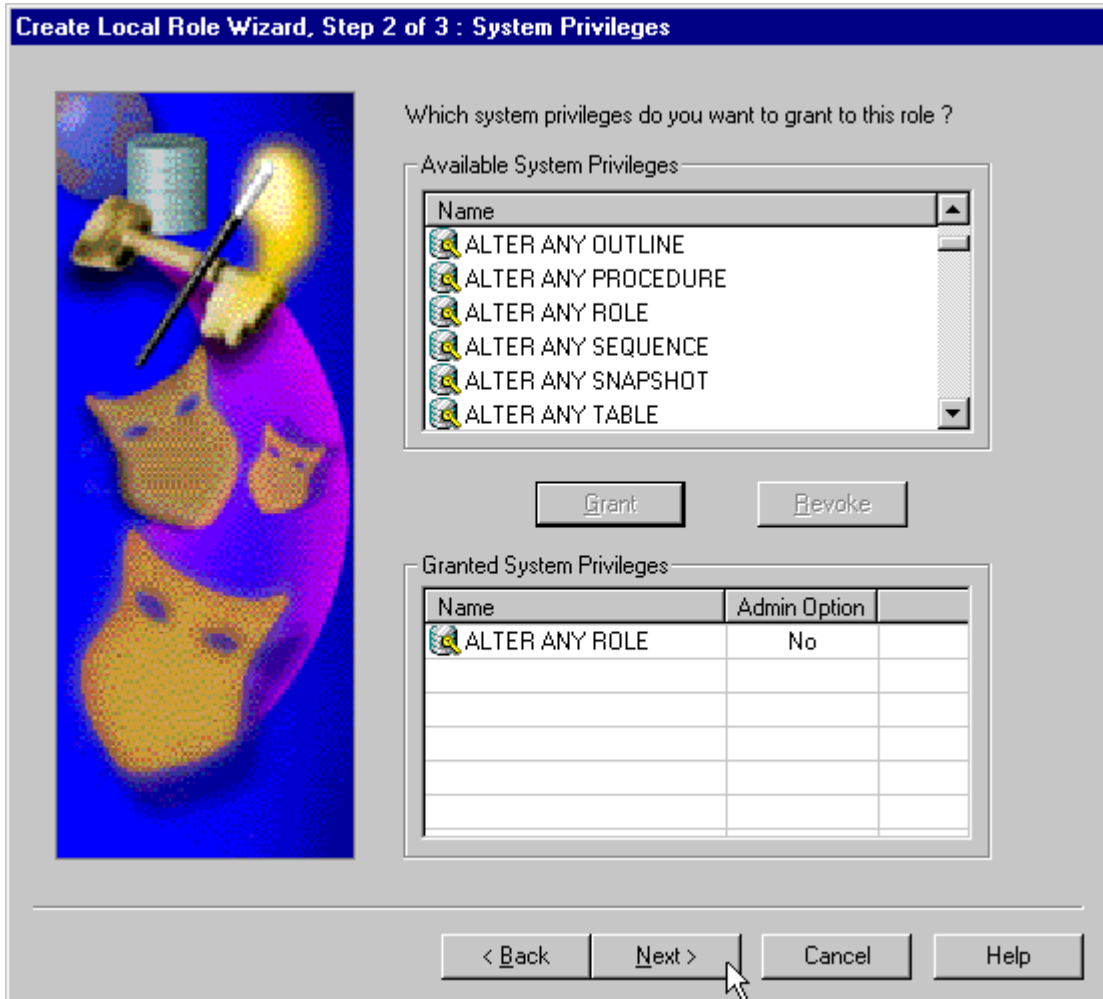

7. In **Available System Privileges** select the system privileges you want to assign to the local role.
8. Click **Grant** to grant the selected system privileges to the local role.

The Granted System Privileges field displays the list of system privileges granted to the local role. To revoke a system privilege, make an appropriate selection, then choose **Revoke**.

9. If you want to grant Admin Option to this role, click the value in the **Admin Option** column to display a list. This enables you to select Yes.
10. Click **Next**. The Roles dialog appears.

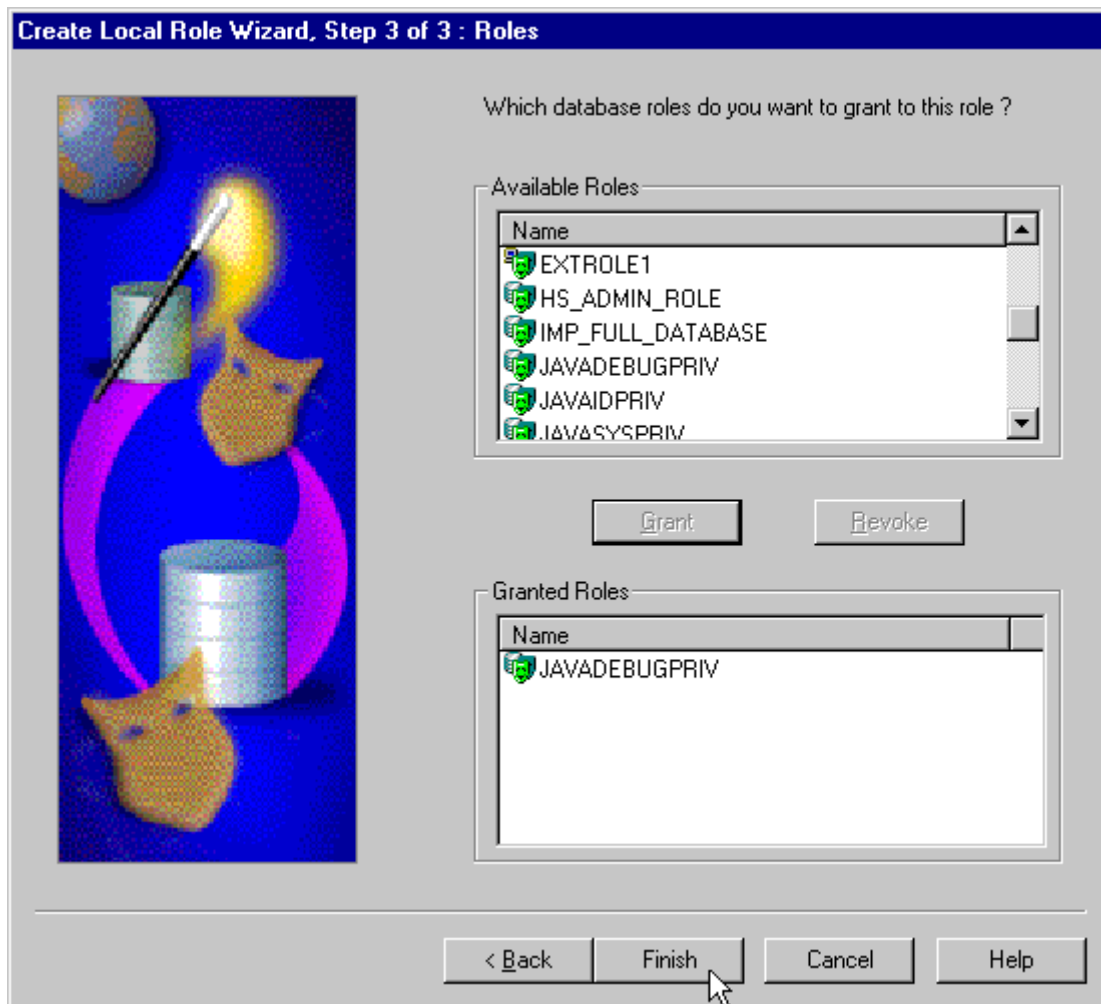

11. In **Available Roles** select the roles you want to assign to the local role. Both local roles and external roles appear in this list.

12. Click **Grant** to grant the selected roles to the role.

The **Granted Roles** field displays the list of roles granted to the role. Both local roles and external roles can appear in this list. To revoke roles, make appropriate selections, then choose **Revoke**.

13. Click **Finish**.

## Creating an External Operating System Role

The **External OS Roles** node of Oracle Administration Assistant for Windows enables you to create an external role and have it managed by the Windows operating system. Once an external role is created, you can grant or revoke that role to a database user. To create an external role:

1. Follow the steps in "[Connecting to a Database](#)" on page 10-9 to connect to a database.
2. Right-click **External OS Roles** for the database for which to create an external role.
3. Choose **Create**.

Create External OS Role Wizard starts, and the first of three wizard dialogs appears. The first dialog is for Name. Authentication: External appears in this dialog to indicate that only external roles can be created.

---

---

**Note:** Create External OS Role Wizard is available only if `init.ora` parameter `OS_ROLES` is set to `true`. If it is set to `false`, then you must first change it to `true` and then restart Oracle Database.

---

---

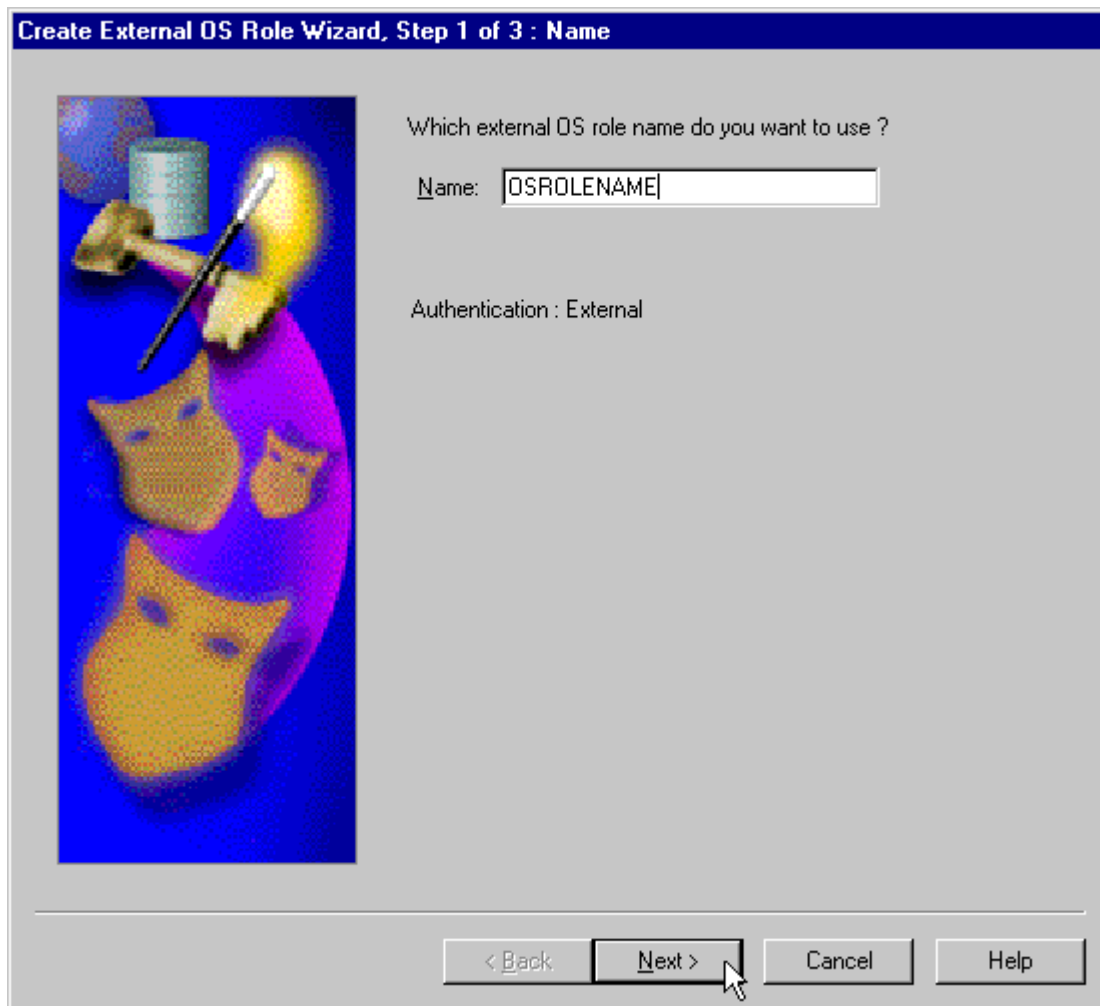

4. Enter an external role name to use. An external role is a role that is managed by the Windows operating system.
5. Click **Next**.  
The System Privileges dialog appears.

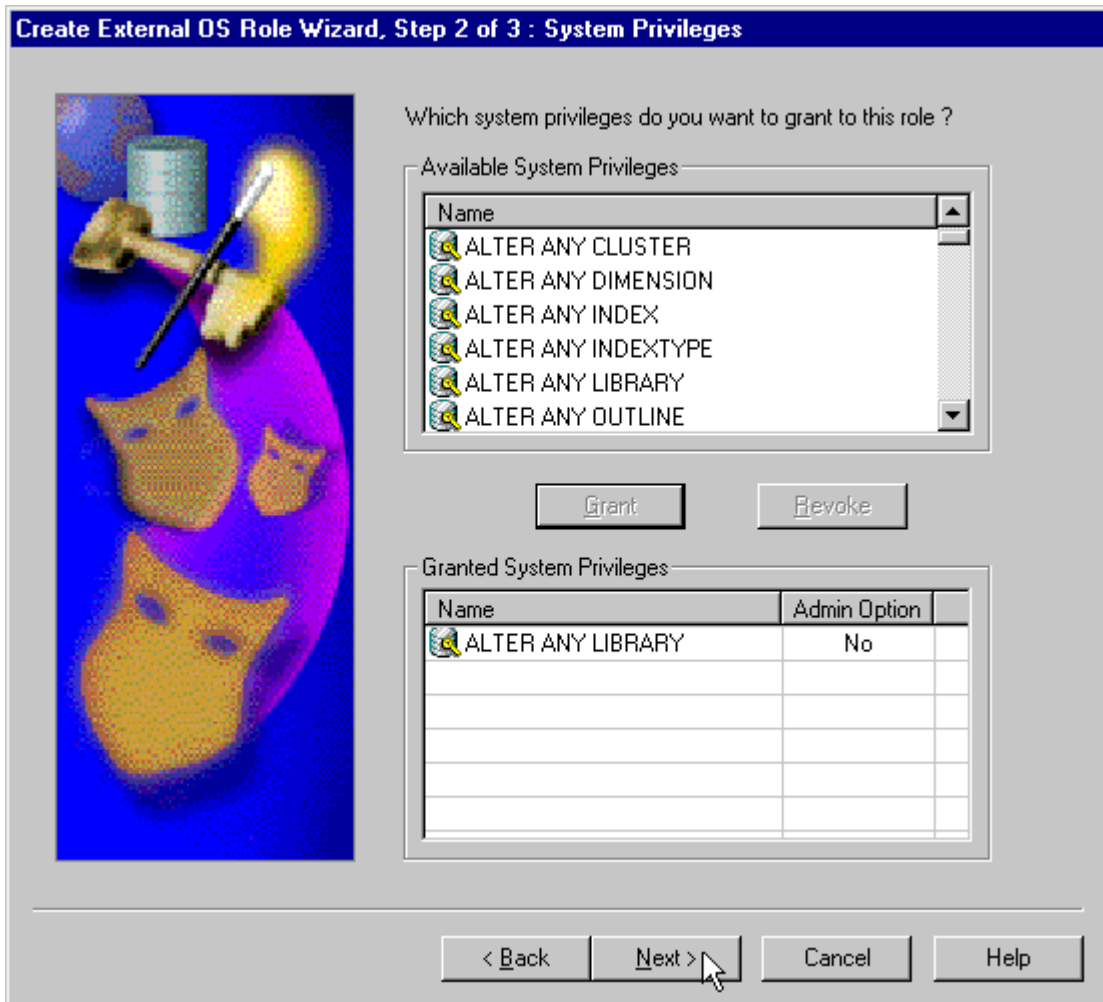

6. In **Available System Privileges** select the system privileges you want to assign to the external role.
7. Choose **Grant** to grant the selected system privileges to the external role.
8. The **Granted System Privileges** field displays the list of system privileges granted to the external role. To revoke a system privilege, make an appropriate selection, then click **Revoke**.

9. If you want to grant Admin Option to this role, choose the value in the **Admin Option** column to display a list. This enables you to select Yes.
10. Click **Next**.

The Roles dialog appears.

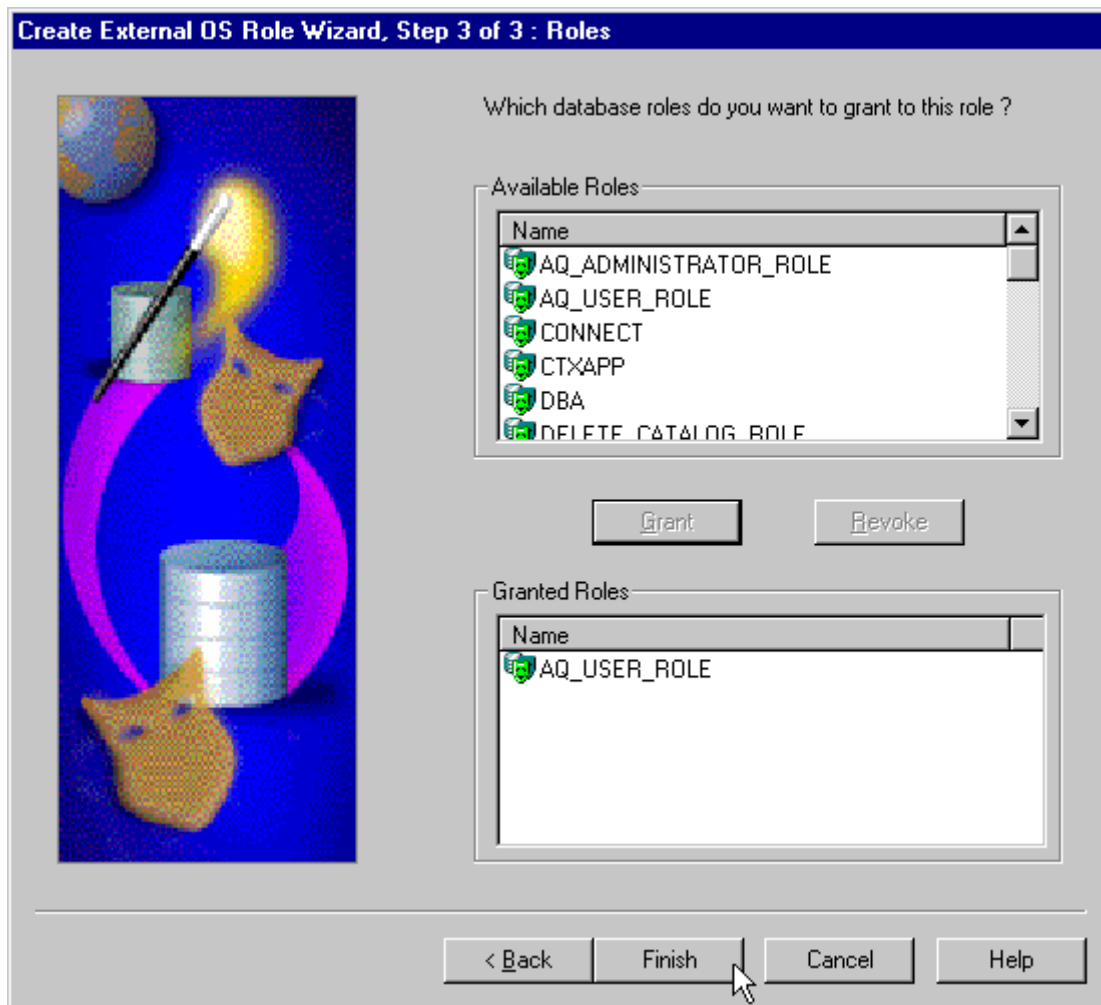

11. In **Available Roles** select the roles you want to assign to the external role. Both local roles and external roles appear in this list.
12. Click **Grant** to grant the selected roles to the external role.



The Granted Roles field displays the list of roles granted to the external role.

13. Click **Finish**.

## Granting Administrator Privileges for a Single Database

The OS Database Administrators node of Oracle Administration Assistant for Windows enables you to authorize a Windows user with SYSDBA privileges for a specific instance on a computer. To grant administrator (SYSDBA) privileges for a single database:

1. Follow the steps in "[Connecting to a Database](#)" on page 10-9 to connect to a database.
2. Right-click **OS Database Administrators**.
3. Choose **Add/Remove**.

The OS Database Administrators for *instance* dialog appears. In the example shown here, the instance is MARK:

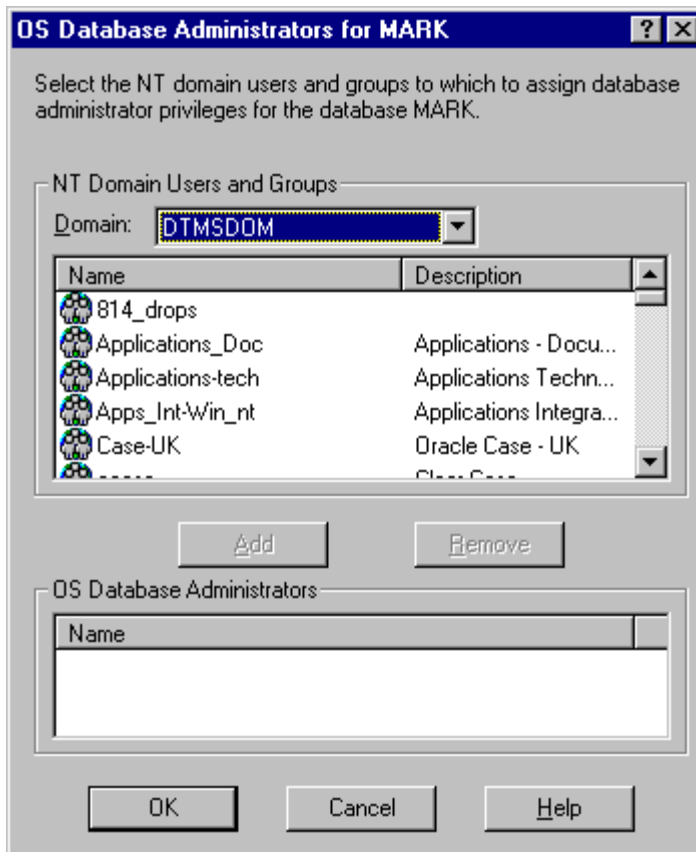

4. In **Domain Users and Groups** select the domain of the user to which to grant SYSDBA privileges from the **Domain** list.
5. Select the user.  
The user now appears in OS Database Administrators.
6. Click **OK**.

## Granting Operator Privileges for a Single Database

The OS Database Operators node of Oracle Administration Assistant for Windows enables you to authorize a Windows user with SYSOPER privileges for a specific

instance on a computer. To grant operator (SYSOPER) privileges for a single database:

1. Follow the steps in "[Connecting to a Database](#)" on page 10-9 to connect to a database.
2. Right-click **OS Database Operators**.
3. Choose **Add/Remove**.

The OS Database Operators for *instance* dialog appears. In the example shown here, the instance is MARK:

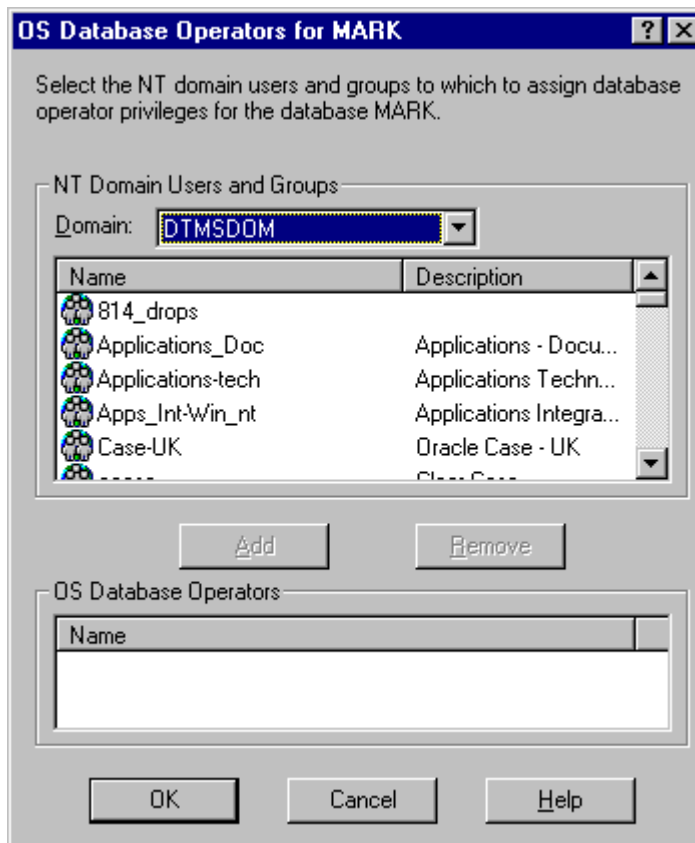

4. In **Domain Users and Groups** select the domain of the user to which to grant SYSOPER privileges from the **Domain** list.
5. Select the user.
6. Click **Add**.  
The user now appears in OS Database Operators.
7. Click **OK**.

## Manually Administering External Users and Roles

Instead of using Oracle Administration Assistant for Windows, you can manually configure administrators, operators, users, and roles to be authenticated by the operating system. Manual configuration involves using Oracle Database command line tools, editing the registry, and creating local groups in Active Directory Users and Computers.

---

---

**Note:** In Windows NT you create local groups in User Manager.

---

---

All of the following can be manually configured to access Oracle Database without a password:

- External operating system users
- Windows database administrators (with SYSDBA privilege)
- Windows database operators (with SYSOPER privilege)

In addition, you can manually create and grant local and external database roles to Windows domain users and global groups.

This section describes:

- [Manually Creating an External Operating System User](#)
- [Manually Granting Administrator and Operator Privileges for Databases](#)
- [Manually Creating an External Role](#)
- [Manually Migrating Users](#)

---

---

**Note:** Use extreme care when manually configuring administrators, operators, users, and roles to be authenticated by the operating system. If possible, use Oracle Administration Assistant for Windows to perform configuration procedures.

---

---

## Manually Creating an External Operating System User

This section describes how to authenticate external operating system users (not database administrators) using Windows, so that a password is not required when accessing the database. When you use Windows to authenticate external operating system users, your database relies solely on the operating system to restrict access to database usernames.

In the following procedure, two Windows usernames are authenticated:

- Local user `frank`
- Domain user `frank` on domain `sales`

Local user `frank` logs into its local Windows client computer to access an instance of Oracle Database, which can be on a different computer. To access other databases and resources on other computers, the local user must provide a username and password each time.

Domain user `frank` on domain `sales` logs into a `sales` domain that includes many other Windows computers and resources, one of which contains an instance of Oracle Database. The domain user can access all the resources the domain provides with a single username and password.

The procedure is divided into two sets of tasks performed on different computers:

- [External User Authentication Tasks on the Oracle Database Server](#)
- [External User Authentication Tasks on the Client Computer](#)

### External User Authentication Tasks on the Oracle Database Server

1. Add parameter `OS_AUTHENT_PREFIX` to your `init.ora` file.

The `OS_AUTHENT_PREFIX` value is prefixed to local or domain usernames attempting to connect to the server with the user's operating system name and password. The prefixed username is compared with Oracle Database usernames in the database when a connection request is attempted. Using parameter `OS_AUTHENT_PREFIX` with Windows native authentication

methods is the recommended method for performing secure, trusted client connections to your server.

2. Set a value for `OS_AUTHENT_PREFIX`. Your choices are:

- Any character string

If you specify `xyz`, as in this procedure's example, then `xyz` is prefixed to the beginning of the Windows username (for example, `xyzfrank` for local user `frank` or `xyzsales\frank` for domain user `frank` on domain `sales`). String values are case insensitive.

- " " (two double quotes with no space between)

This option is recommended, because it eliminates the need for any prefix to Windows usernames (for example, `frank` for local user `frank` or `sales\frank` for domain user `frank` on domain `sales`).

- No value specified

If you do not specify a value for `OS_AUTHENT_PREFIX`, it defaults to `OPS$` (for example, `OPS$frank` for local user `frank` or `OPS$sales\frank` for domain user `frank` on domain `sales`).

3. Create a Windows local username for `frank` with the Computer Management tool, or create a domain username for `frank` with Active Directory Users and Computers (if the appropriate name does not currently exist). See your Windows documentation for detailed instructions.

---

---

**Note:** In Windows NT you can create both local and domain usernames in User Manager.

---

---

4. Do this step *only* if you are *not* authenticating a domain name with a user (for example, just `frank` instead of `frank` on domain `sales`). Otherwise, go to step 8.

- a. Start Registry Editor from the command prompt:

```
C:\> regedt32
```

- b. Go to `HKEY_LOCAL_MACHINE\SOFTWARE\ORACLE\HOMEID`, where `ID` is the Oracle home directory you want to edit.
- c. Choose **Edit > Add Value**.

The Add Value dialog appears:

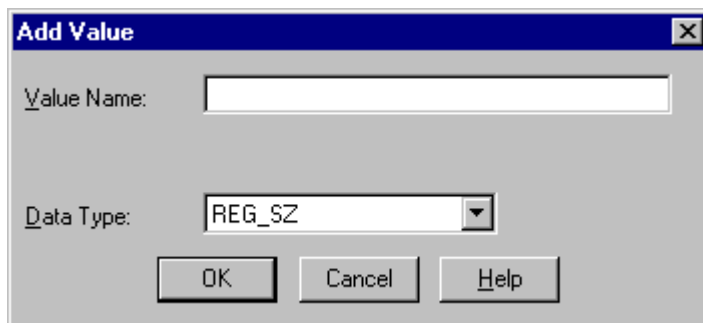

- d. Enter `OSAUTH_PREFIX_DOMAIN` in the **Value Name** field.
- e. Choose `REG_EXPAND_SZ` from the **Data Type** list.
- f. Click **OK**.

The String Editor dialog appears:

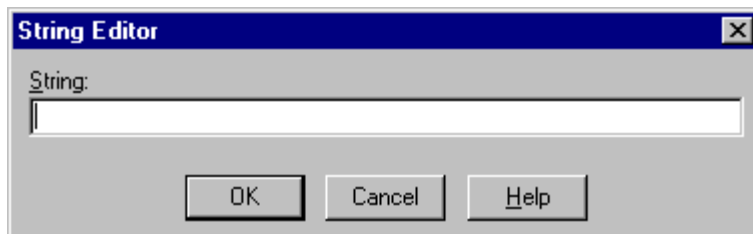

5. Enter `true` in the **String** field to enable authentication at the domain level.  
There may be multiple `frank` usernames on your network, including local user `frank`, domain user `frank` on `sales`, and possibly several domain users `frank` on other domains. Entering `true` enables the server to differentiate among them. Entering `false` causes the domain to be ignored and local user `frank` to become the default value of the operating system user returned to the server.
6. Click **OK**.  
Registry Editor adds the parameter.
7. Choose **Exit** from the **Registry** menu.  
Registry Editor exits.

8. Ensure that parameter `SQLNET.AUTHENTICATION_SERVICES` in file `sqlnet.ora` contains `nts`.

9. Start SQL\*Plus:

```
C:\> sqlplus /NOLOG
```

10. Connect to the database with the **SYSTEM** database administrator (DBA) name:

```
SQL> CONNECT  
Enter user-name: SYSTEM/password
```

Unless you have changed it, the **SYSTEM** password is **MANAGER** by default.

11. Create a local external user by entering:

```
SQL> CREATE USER xyzfrank IDENTIFIED EXTERNALLY;
```

where `xyz` is the value you chose for initialization parameter `OS_AUTHENT_PREFIX`, and `frank` is the Windows local username.

12. Grant a local external user database roles by entering:

```
SQL> GRANT RESOURCE TO xyzfrank;  
SQL> GRANT CONNECT TO xyzfrank;
```

13. Create a domain external user by entering:

```
SQL> CREATE USER "XYZSALES\FRANK" IDENTIFIED EXTERNALLY;
```

where `XYZ` is the value you chose for initialization parameter `OS_AUTHENT_PREFIX`, and `SALES\FRANK` is the domain name and Windows domain username. Double quotes are required and the entire syntax must be in uppercase.

14. Grant a domain external user database roles by entering:

```
SQL> GRANT RESOURCE TO "XYZSALES\FRANK";  
SQL> GRANT CONNECT TO "XYZSALES\FRANK";
```

Double quotes are required and the entire syntax must be in uppercase.

15. Connect to the database with the **SYSDBA** name:

```
SQL> CONNECT / AS SYSDBA
```

16. Shut down the database:

```
SQL> SHUTDOWN
```



17. Restart the database:

```
SQL> STARTUP
```

This causes the change to parameter `OS_AUTHENT_PREFIX` to take effect.

### External User Authentication Tasks on the Client Computer

1. Create Windows local or domain username `frank` with the same username and password that exist on the Windows server (if the appropriate name does not currently exist).
2. Ensure that parameter `SQLNET.AUTHENTICATION_SERVICES` in file `sqlnet.ora` contains `nts`.
3. Use Oracle Net Configuration Assistant to configure a network connection from your client computer to the Windows server on which Oracle Database is installed. See *Oracle Net Services Administrator's Guide* for instructions.

4. Start SQL\*Plus:

```
C:\> sqlplus /NOLOG
```

5. Connect to your Windows server:

```
SQL> CONNECT /@connect_identifier
```

where `connect_identifier` is the net service name for Oracle Database.

Oracle Database searches the **data dictionary** for an automatic login username corresponding to the Windows local or domain username, verifies it, and enables connection as `xyzfrank` or `xyzsales\frank`.

6. Verify that you have connected to Oracle Database as local or domain user `frank` by viewing the roles assigned in steps 12 or 14 of "[External User Authentication Tasks on the Oracle Database Server](#)".

```
SQL> SELECT * FROM USER_ROLE_PRIVS;
```

which outputs for local user `frank`:

USERNAME	GRANTED_ROLE	ADM	DEF	OS_
XYZFRANK	CONNECT	NO	YES	NO
XYZFRANK	RESOURCE	NO	YES	NO

2 rows selected.

or, for domain user frank:

```

USERNAME                                GRANTED_ROLE                            ADM DEF OS_
-----                                -
XYZSALES\FRANK                          CONNECT                                  NO  YES NO
XYZSALES\FRANK                          RESOURCE                                NO  YES NO
2 rows selected.

```

Because the Oracle Database username is the whole name `xyzfrank` or `xyzsales\frank`, each object created by `xyzfrank` or `xyzsales\frank` (that is, table, **view**, index, and so on) is prefixed by this name. For another user to reference the table `shark` owned by `xyzfrank`, for example, the user must enter:

```
SQL> SELECT * FROM xyzfrank.shark
```

---

**Note:** Automatic authorization is supported for all [Oracle Net](#) protocols.

---

## Manually Granting Administrator and Operator Privileges for Databases

This section describes how to enable Windows to grant the database administrator (SYSDBA) and database operator (SYSOPER) privileges to database administrators. With this privilege, database administrators can issue the following commands from a client computer and connect to Oracle Database without entering a password:

```
CONNECT / AS SYSOPER
CONNECT / AS SYSDBA
```

To enable this feature, the Windows local or domain username of the database administrator must belong to one of the Windows local groups listed in [Table 10–1](#).

**Table 10–1 Windows Local Groups with SYSDBA and SYSOPER Privileges**

Local Group	Privileges
ORA_OPER	SYSOPER privileges for all databases on a computer
ORA_DBA <sup>1</sup>	SYSDBA privileges for all databases on a computer
ORA_SID_OPER	SYSOPER privileges for a single database (identified by <i>SID</i> )
ORA_SID_DBA	SYSDBA privileges for a single database (identified by <i>SID</i> )

<sup>1</sup> [ORA\\_DBA](#) is automatically created during installation. See section "[Operating System Authentication Enabled at Installation](#)" on page 9-5 for information.

The manual procedure for enabling database administrators to connect as `SYSOPER` or `SYSDBA` without a password is divided into two sets of tasks performed on different computers:

- [SYSDBA/SYSOPER Authentication Tasks on the Oracle Database Server](#)
- [SYSDBA/SYSOPER Authentication Tasks on the Client Computer](#)

### **SYSDBA/SYSOPER Authentication Tasks on the Oracle Database Server**

1. Create a Windows local group corresponding to the privileges you want Windows to grant (see [Table 10-1](#)).
2. Add your database administrator usernames to this group.

**See Also:** Your Windows documentation for instructions on managing users and groups

3. Ensure that parameter `SQLNET.AUTHENTICATION_SERVICES` in file `sqlnet.ora` contains `nts`.
4. Start Registry Editor from the command prompt:  

```
C:\>regedt32
```
5. Go to `HKEY_LOCAL_MACHINE\SOFTWARE\ORACLE\HOMEID` where `ID` is the Oracle home that you want to edit.
6. Set parameter `OSAUTH_PREFIX_DOMAIN` to `true`.

### **SYSDBA/SYSOPER Authentication Tasks on the Client Computer**

1. Create a Windows local or domain username with the same username and password that exist on the Windows server (if the appropriate username does not currently exist).
2. Ensure that parameter `SQLNET.AUTHENTICATION_SERVICES` in file `sqlnet.ora` contains `nts`.
3. Use Oracle Net Configuration Assistant to configure a network connection from your client computer to the Windows server on which Oracle Database is installed. See *Oracle Net Services Administrator's Guide* for instructions.

4. Start SQL\*Plus:

```
C:\> sqlplus /NOLOG
```

5. Connect to Oracle Database:

```
SQL> SET INSTANCE net_service_name
```

where *net\_service\_name* is the Oracle Net net service name for Oracle Database.

6. If you specified `ORA_DBA` or `ORA_SID_DBA` in step 1 of "[SYSDBA/SYSOPER Authentication Tasks on the Oracle Database Server](#)", then enter either of the following:

```
SQL> CONNECT / AS SYSOPER
```

```
SQL> CONNECT / AS SYSDBA
```

If you specified `ORA_OPER` or `ORA_SID_OPER` in step 1, then enter:

```
SQL> CONNECT / AS SYSOPER
```

You are now connected to the Windows server. If you connect with `SYSDBA`, you are given DBA privileges.

## Manually Creating an External Role

This section describes how to grant Oracle Database roles to users directly through Windows (known as external roles). When you use Windows to authenticate users, Windows local groups can grant these users external roles.

All privileges for these roles are active when the user connects. When using external roles, all roles are granted and managed through the operating system. You cannot use both external roles and Oracle Database roles at the same time.

Consider the following example. With external roles enabled, you log on to a Windows domain with domain username `sales\frank` (`sales` is the domain name and `frank` is the domain username). You then connect to Oracle Database as Oracle Database user `scott`. In this case, you receive the roles granted to `sales\frank` but *not* the roles granted to `scott`.

The procedure for manually creating an external role is divided into two sets of authorization tasks performed on different computers:

- [External Role Authorization Tasks on the Oracle Database Server](#)
- [External Role Authorization Tasks on the Client Computer](#)

## External Role Authorization Tasks on the Oracle Database Server

1. Add initialization parameter `OS_ROLES` to the `init.ora` file.
2. Set `OS_ROLES` to `true`.  
The default setting for this parameter is `false`.
3. Ensure that parameter `SQLNET.AUTHENTICATION_SERVICES` in file `sqlnet.ora` contains `nts`.
4. Start SQL\*Plus:  

```
C:\> sqlplus /NOLOG
```
5. Connect to your Windows server:  

```
SQL> CONNECT / AS SYSDBA
```
6. Create a new database role. You can give this new role whatever name you want. In this example the role is named `DBSALES3`:  

```
SQL> CREATE ROLE DBSALES3 IDENTIFIED EXTERNALLY;
```
7. Grant to `DBSALES3` whatever Oracle Database roles are appropriate to your database environment:  

```
SQL> GRANT DBA TO DBSALES3 WITH ADMIN OPTION;  
SQL> GRANT RESOURCE TO DBSALES3 WITH ADMIN OPTION;  
SQL> GRANT CONNECT TO DBSALES3 WITH ADMIN OPTION;
```
8. Connect to the database as `SYSDBA`:  

```
SQL> CONNECT / AS SYSDBA
```
9. Shut down the database:  

```
SQL> SHUTDOWN
```
10. Restart the database:  

```
SQL> STARTUP
```
11. Create a Windows local group with the following syntax:  

```
ORA_sid_rolename[_D][_A]
```

where

  - `sid` identifies the database instance

- *rolename* identifies the database role granted
- *D* indicates that this database role is to be a default role of the database user
- *A* indicates that this database role includes `ADMIN OPTION`

Characters *D* and *A* are optional. If specified, they must be preceded by an underscore.

For this example, `ORA_orcl_dbsales3_D` is created.

12. Add one or more Windows local or domain usernames to this group.

**See Also:** Your Windows documentation for instructions on managing users and groups

You can create multiple database roles and grant them to several possible Windows groups with differing options, as shown in the following table. Users connecting to the `ORCL` instance and authenticated by Windows as members of all four of these Windows local groups will have the privileges associated with `dbsales3` and `dbsales4` by default (because of option `_D`). If these users first connect as members of `dbsales3` or `dbsales4` and use the `SET ROLE` command, then they can also gain access to database roles `dbsales1` and `dbsales2`. But if these users try to connect with `dbsales1` or `dbsales2` without first connecting with a default role, they are unable to connect. Finally, these users can grant `dbsales2` and `dbsales4` to other roles (because of option `_A`).

Database Roles	Windows Groups
<code>dbsales1</code>	<code>ORA_ORCL_dbsales1</code>
<code>dbsales2</code>	<code>ORA_ORCL_dbsales2_a</code>
<code>dbsales3</code>	<code>ORA_ORCL_dbsales3_d</code>
<code>dbsales4</code>	<code>ORA_ORCL_dbsales4_da</code>

---



---

**Note:** When Oracle Database converts the group name to a role name, it changes the name to uppercase.

---



---

## External Role Authorization Tasks on the Client Computer

1. Create a Windows local or domain username with the same username and password that exist on the Windows server (if the appropriate username does not currently exist).
2. Ensure that parameter `SQLNET.AUTHENTICATION_SERVICES` in file `sqlnet.ora` contains `nts`.
3. Use Oracle Net Configuration Assistant to configure a network connection from your client computer to Oracle Database. See *Oracle Net Services Administrator's Guide* for instructions.

4. Start SQL\*Plus:

```
C:\> sqlplus /NOLOG
```

5. Connect to the correct instance:

```
SQL> SET INSTANCE connect_identifier
```

where *connect\_identifier* is the net service name for the Oracle Database connection that you created in Step 3.

6. Connect to Oracle Database:

```
SQL> CONNECT scott/tiger AS SYSDBA
```

You are connected to the Windows server over net service with Oracle Database username `scott/tiger`. Roles applied to Oracle Database username `scott` consist of all roles defined for the Windows username that were previously mapped to the database roles (in this case, `ORA_DBSALES3_D`). All roles available under an authenticated connection are determined by the Windows username and the Oracle-specific Windows local groups to which the user belongs (for example, `ORA_SID_DBSALES1` or `ORA_SID_DBSALES4_DA`).

---

---

**Note:** OSDBA and OSOPER are generic names for two special operating system groups that control database administrator logins when using operating system authentication. Windows-specific names for OSDBA and OSOPER are described in "[Manually Granting Administrator and Operator Privileges for Databases](#)" on page 10-44. See *Oracle Database Administrator's Guide* for more information on OSDBA and OSOPER.

---

---

## Manually Migrating Users

You can migrate local or external users to enterprise users with User Migration Utility. Migrating from a database user model to an enterprise user model provides solutions to administrative, security, and usability challenges in an enterprise environment. In an enterprise user model, all user information is moved to an LDAP directory service, which provides the following benefits:

- Centralized storage and management of user information
- Centralized user authentication
- Enhanced security

User Migration Utility is a command-line tool. Its syntax is of the form:

```
C:\ umu parameters
```

To get a list of User Migration Utility parameters, enter:

```
C:\ umu help=yes
```

**See Also:** "Using the User Migration Utility" in *Oracle Advanced Security Administrator's Guide*



# 11

---

## Storing Oracle Wallets in the Windows Registry

This chapter describes storing and retrieving of Oracle Wallets in the Windows [registry](#).

This chapter contains these topics:

- [Storing Private Keys and Trust Points](#)
- [Storing User's Profile](#)
- [Registry Parameters for Wallet Storage](#)

## Storing Private Keys and Trust Points

Oracle Wallets store **private keys**, **trust points**, and **digital certificates** used in public key applications for authentication and **encryption**. Oracle Wallet Manager creates and manages Oracle Wallets. Oracle public key applications use obfuscated Oracle Wallets for authentication and encryption.

---

---

**Note:** Oracle Wallet Manager is a feature of Oracle Advanced Security, a separately licensable option to Oracle Database.

---

---

## Storing User's Profile

In a Windows 2000 or Windows NT 4.0 domain, a user's profile is stored on the local computer. When a local user logs on to that computer, that user's profile on the local computer is uploaded into the user profile in that computer's registry. When a user logs out, that user's profile stored on the local file system is updated, ensuring that the domain user or local user always has the most recent user profile version.

## Registry Parameters for Wallet Storage

Parameter `WALLET_LOCATION` in file `sqlnet.ora` specifies the location of the obfuscated Oracle Wallet for use by Oracle PKI applications. For example, the `WALLET_LOCATION` parameter for storing an Oracle Wallet in the registry in:

```
\\HKEY_CURRENT_USER\SOFTWARE\ORACLE\WALLETS\SALESAPP
```

would be:

```
WALLET_LOCATION = (SOURCE= (METHOD=REG) (METHOD_DATA= (KEY=SALESAPP)))
```

Continuing the example, the encrypted Oracle Wallet would be stored in the registry in:

```
\\HKEY_CURRENT_USER\SOFTWARE\ORACLE\WALLETS\SALESAPP\EWALLET.P12
```

and the obfuscated Oracle Wallet would be stored in:

```
\\HKEY_CURRENT_USER\SOFTWARE\ORACLE\WALLETS\SALESAPP\CWALLET.SSO
```

On Windows operating systems, if there is no value specified for parameter `WALLET_LOCATION`, then Oracle PKI applications first look for the obfuscated wallet in registry key:

```
\\HKEY_CURRENT_USER\SOFTWARE\ORACLE\WALLETS\DEFAULT
```

If no obfuscated wallet is found there, Oracle PKI applications look for it in the file system of the local computer at location:

```
%USERPROFILE%\ORACLE\WALLETS
```

Regardless of location, wallets are always stored in the same format. All functionality is the same except for the location of the wallets.

## Oracle Wallet Manager

Oracle Wallet Manager creates and manages Oracle Wallets. If you want to use the Windows registry for Oracle Wallets, then you must select the Use Windows System Registry check box. If Windows System Registry is selected, the tool shows a list of existing keys when it opens a wallet or saves a new wallet. The list appears in:

```
\\HKEY_CURRENT_USER\SOFTWARE\ORACLE\WALLETS
```

You can select one of the existing locations or enter the name for a new location (registry key). If you enter a new key called `key1`, for example, then the tool creates the following registry key:

```
\\HKEY_CURRENT_USER\SOFTWARE\ORACLE\WALLETS\KEY1
```

The encrypted wallet will be stored in:

```
\\HKEY_CURRENT_USER\SOFTWARE\ORACLE\WALLETS\KEY1\EWALLET.P12
```

The obfuscated wallet will be stored in:

```
\\HKEY_CURRENT_USER\SOFTWARE\ORACLE\WALLETS\KEY1\CWALLET.SSO
```

If you do not select the Use Windows System Registry check box, then the tool displays all the available drives and directories on the local computer. You can select one of the existing directories or enter a new directory. The tool stores the encrypted or obfuscated wallet in the selected directory or creates the directory if it does not exist.



---

## Oracle PKI Integration with Windows

This chapter describes integration of Oracle public key infrastructure (PKI) with Windows 2000 public key infrastructure (Windows PKI) on Windows operating systems.

This chapter contains these topics:

- [Oracle Public Key Infrastructure](#)
- [Windows Public Key Infrastructure](#)

## Oracle Public Key Infrastructure

Oracle public key infrastructure (PKI) is used by Oracle Enterprise Security Manager, **LDAP**-enabled Oracle Enterprise Manager, Oracle's Secure Socket Layer (SSL) authentication, Oracle Database, and Oracle Application Server.

Oracle PKI includes the following components:

- Oracle Wallets
- Oracle Wallet Manager (OWM)

Oracle Wallets store **digital certificates**, **trust points**, and **private keys** used in public key applications for **encryption**, **decryption**, **digital signature**, and verification.

## Windows Public Key Infrastructure

This section describes Windows public key infrastructure.

This section contains these topics:

- [Microsoft Certificate Stores](#)
- [Microsoft Certificate Services](#)
- [Using Microsoft Certificate Stores with Oracle PKI Applications](#)

---

---

**Note:** Microsoft Certificate Store integration works only with digital certificates that use Microsoft Enhanced Cryptographic Provider. To create these certificates, you need to install Windows High Encryption Pack and select Microsoft Enhanced Cryptographic Provider. Also, when there are more than one of these certificates available for the same key usage (signature/key exchange), the first certificate retrieved will be used for Oracle SSL.

---

---

## Microsoft Certificate Stores

Microsoft Certificate Stores are repositories for storing digital certificates and their associated properties. Windows 2000 stores digital certificates and certificate revocation lists in logical and physical stores. Logical stores contain pointers to **public key** objects in physical stores. Logical stores enable public key objects to be shared between users, computers, and services without requiring storage of duplicates of objects for each user, computer, or **services**. Public key objects are

physically stored in the **registry** of the local computer or, for some user certificates, in Active Directory. Standard system certificate stores defined by Microsoft include:

- MY or Personal
- CA
- ROOT

MY or Personal holds a user's certificates for which the associated private key is available. The MY certificate store maintains certificate properties that indicate the Cryptographic Service Provider (CSP) associated with the private key. An application uses this information to obtain the private key from the CSP for the associated certificate. CA holds issuing or intermediate **certificate authority** (CA) certificates. ROOT holds only self-signed CA certificates for trusted root CAs.

## Microsoft Certificate Services

Microsoft Certificate Services (MCS) consists of the following modules:

- Server Engine
- Intermediary
- Policy

Server Engine handles all certificate requests. It interacts with other modules at each processing stage to ensure that the proper action is taken based on the state of the request. The Intermediary module receives requests for new certificate from clients and then submits them to Server Engine. The Policy module contains the set of rules controlling the issuance of certificates. This module may be upgraded or customized as needed.

## Using Microsoft Certificate Stores with Oracle PKI Applications

Wallet Resource Locator (WRL) specifies that parameter `WALLET_LOCATION` in file `sqlnet.ora` identifies a particular PKI. You can choose between using Oracle Wallet or Microsoft Certificate Stores by setting parameter `WALLET_LOCATION` in `sqlnet.ora`. To use **credentials** from Microsoft Certificate Stores, set parameter `WALLET_LOCATION` in `sqlnet.ora` to:

```
WALLET_LOCATION = (SOURCE = (METHOD=MCS))
```

The Oracle application uses Oracle's TCP/IP with SSL protocol (TCPS) to connect to Oracle Server. The SSL protocol uses X.509 certificates and trust points from the user's Microsoft Certificate Store for SSL authentication.





---

---

# Oracle Database Specifications for Windows

Oracle Database for Windows uses initialization parameters to enable various features of the database every time an **instance** is started.

This chapter contains these topics:

- [Initialization Parameter File Overview](#)
- [Sample File](#)
- [SGA\\_MAX\\_SIZE Parameter](#)
- [Initialization Parameters Without Windows-Specific Values](#)
- [Displaying Initialization Parameter Values](#)
- [Uneditable Database Initialization Parameters](#)
- [Calculating Database Limits](#)

## Initialization Parameter File Overview

An **initialization parameter file** is an ASCII text file containing parameters. By changing parameters and values in an initialization parameter file, you can specify, for example:

- Amount of memory Oracle Database uses
- Whether to archive filled online redo logs
- Which **control files** currently exist

Every database instance has a corresponding initialization parameter file and an `ORACLE_SID` **registry** parameter that points to the **system identifier** for the instance.

The initialization parameter filename takes the form `init.ora`. A single instance might have several initialization parameter files, each having some differences that affect system performance.

---

---

**Note:** Your `init.ora` file for initialization parameters is set by Oracle Universal Installer during database installation. These parameter settings may vary depending on your hardware configuration. For descriptions of all initialization parameters and instructions for setting and displaying their values, see *Oracle Database Reference*.

---

---

## Location of the Initialization Parameter File

If you do not specify a different initialization file with option `PFILE` at database startup, then by default Oracle Database uses initialization parameter files located in

```
ORACLE_HOME\admin\db_name\pfile\init.ora
```

---

---

**Note:** If you create a database manually using a SQL script, you are required to create an initialization parameter file or copy an existing initialization parameter file and modify the contents. If you use Database Configuration Assistant to create a database, the initialization parameter file is automatically created for you.

---

---

## Editing The Initialization Parameter File

To customize Oracle Database functions, you may be required to edit the initialization parameter file. Use only an ASCII text editor to modify the file.

## Database Configuration Assistant Renames `init.ora`

When you create a database using Database Configuration Assistant, a server parameter file (SPFILE) is created from the initialization parameter file, and the initialization parameter file is renamed. Oracle does not recognize the renamed file as an initialization parameter file, and it is not used after the instance is started.

If you want to modify an instance created with Database Configuration Assistant after it starts up, you must use `ALTER SYSTEM` statements. You cannot change the SPFILE itself, because it is a binary file that cannot be browsed or edited using a text editor. The location of the newly-created SPFILE is `ORACLE_BASE\ORACLE_HOME\database`. The SPFILE filename is `spfileSID.ora`.

**See Also:** "Managing Initialization Parameters Using a Server Parameter File" in *Oracle Database Administrator's Guide*

## Sample File

Oracle Database provides an annotated sample initialization parameter file with alternative values for initialization parameters. These values and annotations are preceded by comment signs (`#`), which prevent them from being processed. To activate a particular parameter, remove the preceding `#` sign. To de-activate a particular parameter, edit the initialization parameter file to add a comment sign. The sample file is called `init.ora` and is located in

`ORACLE_BASE\ORACLE_HOME\admin\sample\pfile`.

If you installed a **starter database**, the initialization parameter file used by the starter database is located in the same directory. You can use either `init.ora` or the starter database `init.ora` as a basis for creating a new Oracle Database initialization parameter file.

To use sample file `init.ora` as part of database creation:

1. Rename the sample file `init.ora`.
2. Edit this file to reflect the correct location of your database control files and the name of your database, as a minimum.

Here are two examples of activation and de-activation of alternative parameters. Several initialization parameters are specified with three different values to create a small, medium, or large **System Global Area**, respectively. The parameter that creates a small SGA is active in this first example:

```
db_block_buffers = 200 # SMALL
# db_block_buffers = 550 # MEDIUM
# db_block_buffers = 3200 # LARGE
```

To create a medium-sized SGA, comment out the small parameter definition and activate the medium parameter definition. Edit the initialization parameter file as in this second example:

```
# db_block_buffers = 200 # SMALL
db_block_buffers = 550 # MEDIUM
# db_block_buffers = 3200 # LARGE
```

## SGA\_MAX\_SIZE Parameter

Parameter `SGA_MAX_SIZE` holds the maximum size that System Global Area (SGA) can reach for a particular instance. Beginning with Oracle9i release 1 (9.0.1), Oracle Database can change its SGA configuration while the instance is running. This allows sizes of buffer cache, shared pool, and large pool to be changed without instance shutdown.

Oracle Database can start instances underconfigured and allow the instance to use more memory by growing SGA up to a maximum of `SGA_MAX_SIZE`. If no `SGA_MAX_SIZE` value is specified, then Oracle Database selects a default value that is the sum of all components specified or defaulted at initialization time. If `SGA_MAX_SIZE` specified in the initialization parameter file is less than the sum of all components specified or defaulted to at initialization time, then the setting of `SGA_MAX_SIZE` in the initialization parameter file is ignored.

### See Also:

- *Oracle Database Performance Tuning Guide* for more information about SGA initialization parameters.
- *Oracle Database Concepts* for more information about SGA and its components

Memory allocated for the SGA of an instance is displayed on instance startup when using Oracle Enterprise Manager (or SQL\*Plus). You can also display the SGA size of the current instance by using the SQL\*Plus SHOW statement with the SGA clause.

## Initialization Parameters Without Windows-Specific Values

*Oracle Database Reference* describes default values for many initialization parameters as being operating system-specific. However, not all parameters that it describes as having operating system-specific values affect Windows. In these cases, Windows uses either the default value set in the Oracle Database kernel or does not use the parameter. [Table 13–1](#) describes these initialization parameters:

**Table 13–1 Initialization Parameters Without Windows-Specific Values**

Parameter	Description
AUDIT_FILE_DEST	Not supported on Windows and should not be added to the initialization parameter file
DB_WRITER_PROCESSES	Supported, but typically unnecessary due to Windows asynchronous I/O capabilities
COMPATIBLE_NO_RECOVERY	Uses default value set in Oracle Database kernel (no Windows-specific value)
BACKGROUND_CORE_DUMP	Specifies whether Oracle Database includes SGA in core file for Oracle Database background processes
SHADOW_CORE_DUMP	Specifies whether Oracle Database includes SGA in core file for foreground (client) processes
CORE_DUMP_DEST	Specifies directory where Oracle Database dumps core files
CPU_COUNT	Oracle Database automatically sets value to number of processors available for your Oracle Database instance
HI_SHARED_MEMORY_ADDRESS	Not applicable to Windows
SHARED_MEMORY_ADDRESS	Not applicable to Windows
LARGE_POOL_SIZE	Uses maximum value limited by available memory
LOG_BUFFER	Starter database uses value set in Oracle Database kernel (no Windows-specific value). The Custom database creation option of Database Configuration Assistant enables you to customize the value for this parameter.
SPIN_COUNT	Uses default value set in Oracle Database kernel (no Windows-specific value)

## Displaying Initialization Parameter Values

Windows-specific parameter values can be viewed by using an ASCII editor to open the initialization parameter file:

```
ORACLE_BASE\ORACLE_HOME\admin\db_name\pfile\init.ora
```

To display any parameter value (whether set in the initialization parameter file or the Oracle Database kernel), enter the following command at the SQL\*Plus command prompt:

```
SQL> SHOW PARAMETER parameter_name
```

where *parameter\_name* is the name of a specific initialization parameter.

## Uneditable Database Initialization Parameters

Check the initialization parameters in [Table 13–2](#) when creating a new database. They cannot be modified after you have created the database. See [Chapter 4, "Postinstallation Database Creation on Windows"](#) for details on creating a new database, including the part of the procedure where you modify these parameters.

**Table 13–2 Uneditable Database Initialization Parameters**

Parameter	Description
CHARACTER SET <sup>1</sup>	Specifies database <a href="#">Globalization Support</a> character set to use. This parameter can be set only when you create the database.
DB_BLOCK_SIZE	Specifies size in bytes of standard Oracle Database blocks.
DB_NAME	Specifies name of the database to be created. Database name is a string of eight characters or less. You cannot change the name of a database.

<sup>1</sup> Not an initialization parameter, but rather a clause in the CREATE DATABASE statement. See [Chapter 4, "Postinstallation Database Creation on Windows"](#) for an example of using this clause.

## Calculating Database Limits

Use size guidelines in this section to calculate Oracle Database limits.

**Table 13–3 Block Size Guidelines**

Type	Size
Maximum block size	16,384 bytes or 16 kilobytes (KB)
Minimum block size	2 kilobytes (KB)
Maximum blocks for each file	4,194,304 blocks
Maximum possible file size with 16 K sized blocks	64 Gigabytes (GB) (4,194,304 * 16,384) = 64 gigabytes (GB)

**Table 13–4 Maximum Number of Files for Each Database**

Block Size	Number of Files
2 KB	20,000
4 KB	40,000
8 KB	65,536
16 KB	65,536

**Table 13–5 Maximum File Sizes**

Type	Size
Maximum file size for a FAT file	4 GB
Maximum file size in NTFS	16 Exabytes (EB)
Maximum database size	65,536 * 64 GB equals approximately 4 Petabytes (PB)
Maximum control file size	20,000 blocks

**Table 13–6 Shadow Process Memory**

Release Number	Memory
Oracle9i release 2 (9.2)	444 KB
Oracle9i release 1 (9.0.1)	444 KB
Oracle8i release 8.1.7	335 KB

**Table 13–6 (Cont.) Shadow Process Memory**

<b>Release Number</b>	<b>Memory</b>
Oracle8i release 8.1.6	335 KB
Oracle8 release 8.1.3	265 KB
Oracle8 release 8.0.5	254 KB
Oracle8 release 8.0.4	254 KB



---

# Configuration Parameters and the Registry

This chapter describes use of the [registry](#) for various Oracle Database for Windows components. It also lists recommended values and ranges for configuration parameters.

This chapter contains these topics:

- [About Configuration Parameters](#)
- [Registry Overview](#)
- [Registry Parameters](#)
- [Oracle Real Application Clusters Registry Parameters](#)
- [Modifying a Registry Value with regedt32](#)
- [Adding a Registry Parameter with regedt32](#)
- [Adding or Modifying Registry Parameters with Oracle Administration Assistant for Windows](#)
- [Modifying Oracle Counters for Windows Performance Monitor Parameters](#)

## About Configuration Parameters

Oracle Database for Windows uses configuration parameters to locate files and specify runtime parameters common to all Oracle products. When an Oracle program or application requires a translation for a particular configuration variable, Oracle Database for Windows uses the associated parameter. All Oracle parameters are stored in the registry.

## Registry Overview

Oracle Database for Windows stores its configuration information in a repository (the registry) that is organized in a tree format. The tree format consists of keys in the registry and parameter values for the keys. Keys and parameter values can be viewed and modified in Registry Editor.

Keys are folders that appear in the left pane of a Registry Editor window. A key contains subkeys or parameters.

---

---

**Caution:** Although Registry Editor lets you view and modify registry keys and parameter values, you normally are not required to do so. In fact, you can render your system useless if you make incorrect changes. Therefore, only advanced users should edit the registry! Back up your system before making any changes in the registry.

---

---

Parameters in Registry Editor appear as a string, consisting of three components:

- Parameter name
- Value class or type of entry
- Value itself

For example, parameter ORACLE\_SID can have the following entry in the registry:

```
ORACLE_SID:reg_sz:orcl1
```

Value classes for Oracle Database for Windows parameters are:

- String value with a REG\_SZ, REG\_EXPAND\_SZ (for an expandable string), or a REG\_MULTI\_SZ (for multiple strings) prefix to identify a parameter value entry as a data string

- Binary value with a REG\_DWORD prefix to identify a value entry as a dword (hexadecimal data) entry

Most Oracle Database for Windows parameter values are string types. Use Oracle Universal Installer defaults when a type is not given.

## Registry Parameters

This section describes Oracle Database for Windows registry parameters for the following keys. Other products, such as Oracle Enterprise Manager, have additional keys and parameters that are not described in this chapter.

- `HKEY_LOCAL_MACHINE\SOFTWARE\ORACLE\KEY_HOME_NAME`
- `HKEY_LOCAL_MACHINE\SOFTWARE\ORACLE`
- `HKEY_LOCAL_MACHINE\SYSTEM\CurrentControlSet\Services`

To modify these registry values, see ["Modifying a Registry Value with regedt32"](#) on page 14-11.

### HKEY\_LOCAL\_MACHINE\SOFTWARE\ORACLE\KEY\_HOME\_NAME

Each time you install Oracle products into a new Oracle home on your computer, `HKEY_LOCAL_MACHINE\SOFTWARE\ORACLE\KEY_HOME_NAME` is created. This subkey contains parameter values for most Oracle products.

---



---

**Note:** See [Chapter 2, "Multiple Oracle Homes and Optimal Flexible Architecture"](#) for details on the PATH variable and registry values when you are working with **multiple Oracle homes**.

---



---

`HKEY_LOCAL_MACHINE\SOFTWARE\ORACLE\HKEY_LOCAL_MACHINE\SOFTWARE\ORACLE\KEY_HOME_NAME` includes the following parameters for an Oracle home directory. Depending on products you install, additional parameters can also be created. See your Windows development manuals.

#### MSHELP\_TOOLS

Specifies the location of Windows help files. The default value is `ORACLE_BASE\ORACLE_HOME\mshelp`.

### **NLS\_LANG**

Specifies supported language, territory, and character set. This parameter specifies the language in which messages appear, the territory and its conventions for calculating week and day numbers, and the character set displayed. Oracle Universal Installer sets this value during installation based on the language setting of the operating system. See *Oracle Database Globalization Support Guide* for a list of values.

### **ORA\_CWD**

Specifies current working directory. For example, if you set this parameter and then use ORADIM, a log file called oradim.log is created in this directory. This parameter must be manually set.

### **ORA\_SID\_AUTOSTART**

Starts Oracle Database when OracleServiceSID service is started. The default value is `true`.

### **ORA\_SID\_PFILE**

Specifies full path to [initialization parameter file](#). The default value is `ORACLE_BASE\admin\DB_NAME\pfile\init.ora`

### **ORA\_SID\_SHUTDOWN**

When set to `true`, the default value, this parameter shuts down the instance of Oracle Database identified by *SID* when OracleServiceSID is stopped manually—using either the Control Panel or Net stop command.

### **ORA\_SID\_SHUTDOWN\_TIMEOUT**

Sets maximum time (in seconds) to wait for shutdown to complete before the service for a particular SID stops. The default value is 30.

### **ORA\_SID\_SHUTDOWNTYPE**

Specifies mode in which Oracle Database is shut down when you stop OracleServiceSID. Valid values are `a` (abort), `i` (immediate), and `n` (normal). The default value is `i`.

## ORA\_TZFILE

Specifies location of time zone file. Each file contains:

- Valid time zone names
- Offset from UTC
- Abbreviation for standard time
- Abbreviation for daylight savings time

`ORACLE_BASE\ORACLE_HOME\oracore\zoneinfo\timezone.dat` is the default value. It contains most commonly used time zones and is smaller for better database performance. The optional file, `timezlg.dat`, includes time zones not defined in the default; but its use may affect database performance. To enable use of the optional file, the database administrator must:

1. Shut down Oracle Database.
2. Set `ORA_TZFILE` to the full path name of the location of `timezlg.dat` file.
3. Restart Oracle Database.

To view time zone names, use SQL\*Plus to make the following query:

```
SELECT * from v$timezone_names
```

Once the larger file is used, it must stay in use unless the user is sure that no data uses one of the added time zones. Also, all databases that share information must use the same time zone file.

## ORACLE\_AFFINITY

Specifies Windows processor affinity of each **thread** within the Oracle Database **process**. This parameter must be manually added. Oracle recommends consulting Oracle Support Services before changing this parameter. The format is:

```
name1:cpumask1;name2:cpumask2
```

Each name setting must be the name of a background thread, `user` for non-background (shadow) threads, or `def` for any thread type not handled specifically.

The name mask sets the affinity mask of the Oracle Database process. Valid background thread names include `DBW0`, `LGWR`, `PMON`, `SMON`, `ARCH`, `RECO`, `CKPT`, `TRWR`, `SNP0` through `SNP9`, `P000` through `P481`, and any other name found in the `NAME` column of the `v$bgprocess` [data dictionary view](#).

Each affinity setting must be a valid affinity mask (or its numeric equivalent) for the corresponding name. Process affinity masks are used only when **Oracle services** are first started. Each thread's affinity is set only when the individual thread is started (for example, at database startup time for the background threads).

### **ORACLE\_BASE**

Specifies the top-level Oracle directory (for example, `C:\oracle`) that contains `ORACLE_HOME`, `\admin`, and `\oradata`. The default is `ORACLE_BASE`.

### **ORACLE\_GROUP\_NAME**

Specifies the name of the group containing icons of the Oracle products installed. The parameter is added to your registry when you first install Oracle products, even if Oracle Universal Installer does not create a program group for Oracle products you have installed (for example, if you have installed only **Oracle Net** software). The default value is `Oracle - HOME_NAME`.

### **ORACLE\_HOME**

Specifies Oracle home directory in which Oracle products are installed. This directory is immediately beneath the Oracle base directory in the Oracle directory hierarchy. The default value is the drive letter and name that you specify during installation.

### **ORACLE\_HOME\_KEY**

The `HKEY_LOCAL_MACHINE` location of Oracle parameters. The default value is `software\oracle\HOMEID`.

### **ORACLE\_HOME\_NAME**

Specifies home name of Oracle home directory in which Oracle products are installed. The default value is the name that you specify during installation.

### **ORACLE\_PRIORITY**

Determines Windows scheduling priorities of threads within the Oracle Database management system process. The format is:

```
name1:priority1;name2:priority2 . . .
```

The name class sets the `priority` class of the Oracle Database process. Threads can be assigned priority either collectively or individually. The collective name `user` designates non-background (shadow) threads; the collective name `def` designates

any thread type not handled specifically. Valid individual background thread names include DBW0, LGWR, PMON, SMON, ARCH0, RECO, CKPT, TRWR, SNP0 through SNP9, and any other name found in the NAME column of the v\$bgprocess data dictionary view.

The default value is `class:normal; def:normal`.

---

---

**Note:** ORACLE\_PRIORITY is not automatically created for you in the registry. When it is not defined in the registry, Windows default values are used for thread priorities.

---

---

## ORACLE\_SID

Specifies the name of the Oracle Database **instance** on the host computer. The value of this parameter is the SID for the instance. The default value is specified by the entry in the Database Identification window of Oracle Universal Installer.

## OSAUTH\_PREFIX\_DOMAIN

Enables user authentication. When it is set to `true`, it enables the server to differentiate between one **username** and another, whether they are local users, domain users, or domain users on another domain in your network. When it is set to `false`, the domain is ignored, and the local user becomes the default value of the operating system user returned to the server. The default value is `false`.

## OSAUTH\_X509\_NAME

Enables client users to access Oracle Database as X.509-compliant enterprise users. This parameter is required only if you want to use enterprise users and roles in an Oracle Database computer running in a Windows 2000 domain. The default value is `false`.

## RDBMS\_ARCHIVE

Specifies the location of **backup** database files. The default value is `ORACLE_BASE\ORACLE_HOME\database\archive`.

## RDBMS\_CONTROL

Specifies the location of backup database **control files**. The default value is `ORACLE_BASE\ORACLE_HOME\database`.

### **SQLPATH**

Specifies the location of SQL scripts. The default value is *ORACLE\_BASE\ORACLE\_HOME\dbs*.

## **HKEY\_LOCAL\_MACHINE\SOFTWARE\ORACLE**

This subkey contains the following parameters:

### **INST\_LOC**

Specifies the location of Oracle Universal Installer files. The default value is *System Drive:\program files\oracle\inventory*.

### **OO4O**

Specifies the location of Oracle Objects for OLE message files. The default value is *ORACLE\_BASE\ORACLE\_HOME\oo4o\mesg*.

## **HKEY\_LOCAL\_MACHINE\SYSTEM\CurrentControlSet\Services**

*HKEY\_LOCAL\_MACHINE\SYSTEM\CurrentControlSet* contains four keys:

- Control
- Enum
- HardwareProfiles
- Services

The first three are used by the operating system. You can edit only the *Services* subkey, which contains:

- [Parameters for Oracle Counters for Windows Performance Monitor](#)
- [Parameters for Oracle Database Services](#)

### **Parameters for Oracle Counters for Windows Performance Monitor**

Oracle Counters for Windows Performance Monitor parameters appear in:

*HKEY\_LOCAL\_MACHINE\SYSTEM\CURRENTCONTROLSET\SERVICES\ORACLEver\PERFORMANCE*

where *ORACLEver* refers to whatever version of Oracle Database is installed.



---



---

**Note:** Modify only the `hostname`, `password`, and `username` values to point to any database. Oracle recommends that you use `OPERFCFGver`. See "[Using OPERFCFGver](#)" on page 14-20.

---



---

For Oracle Counters for Windows Performance Monitor to display information for Oracle Database performance objects, it must log in to the database. Modify the following parameters if the default information is not applicable or if you want to access another database:

- `Hostname` displays the SID of the database that Oracle Counters for Windows Performance Monitor will connect to. The default value is blank, causing Oracle Counters for Windows Performance Monitor to connect to the default database on the computer.

If you specify a different SID, you must also add a connect descriptor for that SID to your `tnsnames.ora` file. Oracle recommends that you use Oracle Net Configuration Assistant, but you can also copy, paste, and modify the following example:

```
SERVICE_NAME =
  (DESCRIPTION =
    (ADDRESS_LIST =
      (ADDRESS = (PROTOCOL = TCP)(HOST = HOST_NAME)(PORT = 1521))
    )
    (CONNECT_DATA =
      (SERVER = DEDICATED)
      (SERVICE_NAME = SERVICE_NAME)
    )
  )
```

- `Password` displays the encrypted password for the username to access the database. The default value is `MANAGER` (encrypted).
- `Username` displays the username to access the database. The default value is `SYSTEM`.

Oracle Counters for Windows Performance Monitor requires the following parameters as entry points:

- `Close` specifies the close entry point for the DLL. The default value is `CloseOracleverPerformanceData`.
- `Collect` specifies the collect entry point for the DLL. The default value is `CollectOracleverPerformanceData`.

- `Library` specifies the name of the Oracle Counters for Windows Performance Monitor DLL. The default value is `ORAPERFver.dll`
- `Open` specifies the open entry point for the DLL. The default value is `OpenOracleverPerformanceData`.

The following parameters specify Oracle Counters for Windows Performance Monitor log file and object configuration files:

- `LOGFILE` specifies the name of the Oracle Counters for Windows Performance Monitor log file. This log file reports any errors, such as Oracle Database objects not appearing or database access problems. The default value is `ORACLE_BASE\ORACLE_HOME\db\operfver.log`.
- `PERF_FILE_NAME` specifies the location of the `PERFver.ora` file, which contains all performance objects displayed by Oracle Counters for Windows Performance Monitor. The default value is `ORACLE_BASE\ORACLE_HOME\db\perfver.ora`

### Parameters for Oracle Database Services

`HKEY_LOCAL_MACHINE\SYSTEM\CURRENTCONTROLSET\SERVICES` subkey contains additional subkeys that correspond to each Oracle Database service.

Each service subkey contains the following parameters:

- `DisplayName` specifies the service name of the instance whose `SID` is `SID`. The default value is the name of the service. For example, `OracleServiceORCL1`, where `ORCL1` is the `SID`.
- `ImagePath` specifies the fully qualified path name of the executable started by the service and any command-line arguments passed into the executable at runtime. The default value is the path to the executable file of the product.
- `ObjectName` specifies the logon user account and computer to which the service should log on. The default value is `LocalSystem`.

## Oracle Real Application Clusters Registry Parameters

Oracle Real Application Clusters registry values are based on the clusterware. If you are not using the clusterware, then some of this information may not be applicable to your particular cluster environment.

---

---

**Note:** Oracle Real Application Clusters is not supported on Windows XP.

---

---

## HKEY\_LOCAL\_MACHINE\SOFTWARE\ORACLE\OCR

This subkey contains the following values:

- OCRROOT points to the location of the Oracle Cluster Registry file
- LOCAL\_ONLY which is set to `False` for a cluster installation and `True` for a single-instance database installation

## Modifying a Registry Value with regedt32

---

---

**Caution:** Do not edit your registry unless absolutely necessary. If an error occurs in your registry, then Oracle Database for Windows can stop functioning, and the registry itself can become unusable.

---

---

To edit Oracle-related settings:

1. Start Registry Editor in one of two ways:

- From the command prompt, enter:

```
C:\> regedt32
```

- Choose **Start > Run**, enter `regedt32` in the **Open** field, and click **OK**.

The Registry Editor window appears.

2. Navigate to the values you want to view or modify by double-clicking appropriate keys.

The left-hand side of the window shows the hierarchy of registry keys, and the right-hand side of the window shows various values associated with a key.

3. Double-click the parameter to edit.

The String Editor dialog appears:



4. Make any necessary edits.
5. Click **OK**.
6. Choose **Exit** from the **Registry** menu.

## Adding a Registry Parameter with regedt32

To add a parameter to the registry:

1. Start Registry Editor in one of two ways:
  - From the command prompt, enter:  

```
C:\> regedt32
```
  - Choose **Start > Run**, enter `regedt32` in the **Open** field, and click **OK**.  
The Registry Editor window appears.
2. Navigate to the key to which you want to add the new value.
3. Choose **Add Value** from the **Edit** menu.  
The Add Value dialog appears:

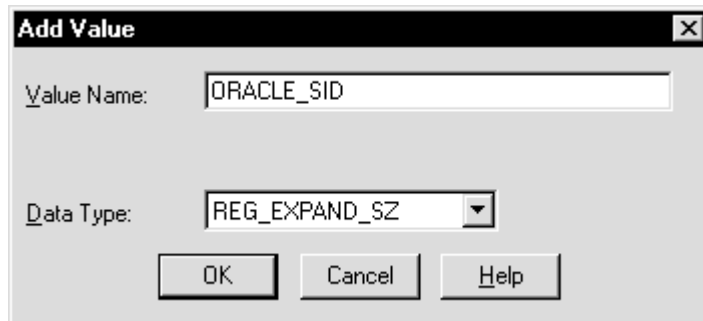

4. In the **Value Name** field, type the name of the value that you want to add to the currently selected key.
5. In the **Data Type** list, select the data type that you want to assign to the added value:
  - REG\_SZ, REG\_EXPAND\_SZ (for an expandable string), or REG\_MULTI\_SZ (for multiple strings) for a data string
  - Binary value with a REG\_DWORD prefix to identify a value entry as a DWORD (hexadecimal data) entry
6. Click **OK**.

The String Editor dialog appears:

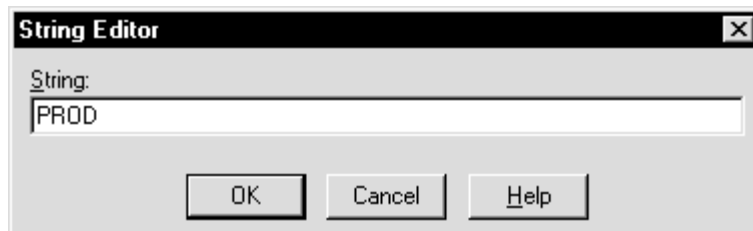

7. Type the value for the parameter.
8. Click **OK**.  
Registry Editor adds the parameter.
9. Choose **Exit** from the **Registry** menu.

## Adding or Modifying Registry Parameters with Oracle Administration Assistant for Windows

Instead of using `regedt32` to add, edit, and delete parameters for an Oracle home, you can use the Oracle Home Configuration snap-in, one of several **snap-ins** included as part of Oracle Administration Assistant for Windows. You must have **Microsoft Management Console** on your computer to use this product.

See "[HKEY\\_LOCAL\\_MACHINE\SOFTWARE\ORACLE\KEY\\_HOME\\_NAME](#)" on page 14-3 for more information about Oracle home parameters.

### Starting Oracle Administration Assistant for Windows

To start Oracle Administration Assistant for Windows:

1. Choose **Start > Programs > Oracle - HOME\_NAME > Configuration and Migration Tools > Administration Assistant for Windows**.

Oracle Administration Assistant for Windows starts.

2. Expand **Oracle Homes**.
3. Right-click the Oracle home that you want to modify.

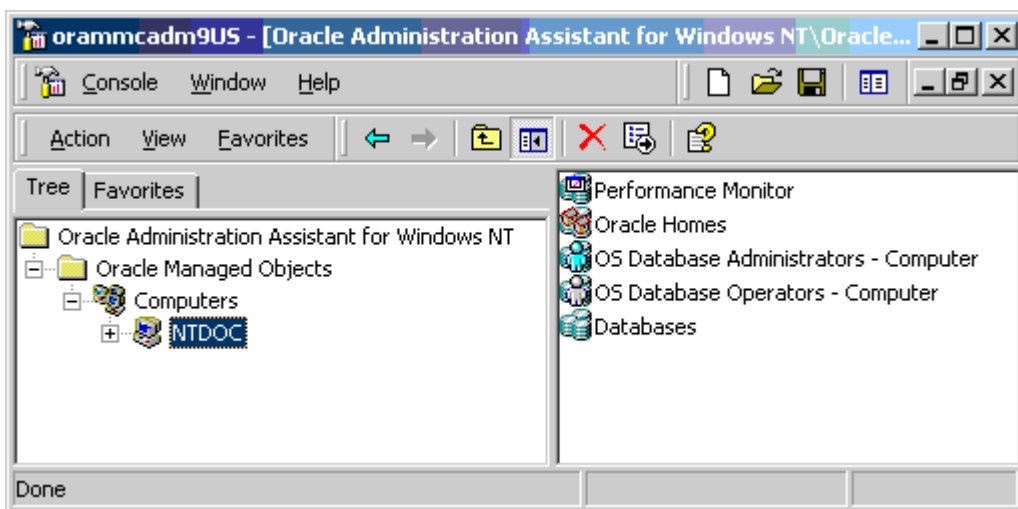

4. Click **Properties**. The Properties dialog appears.

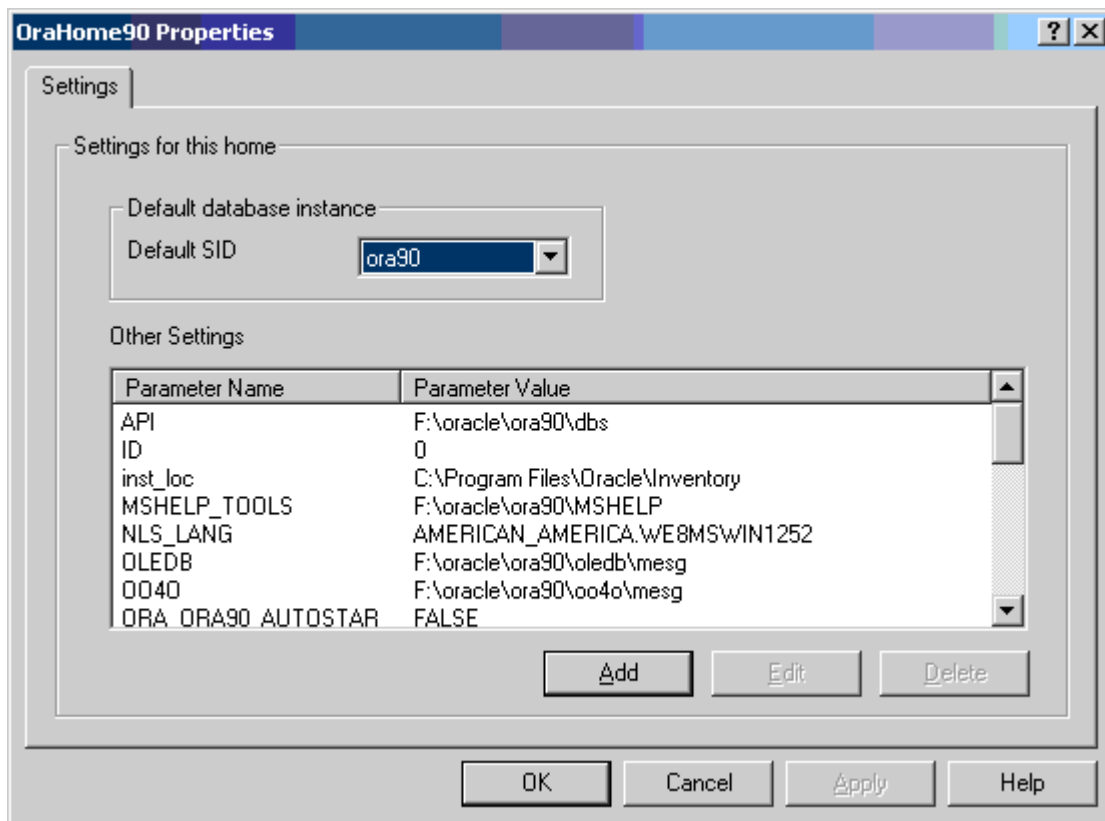

## Adding Oracle Home Parameters

To add an Oracle home parameter:

1. Click **Add** in the Properties dialog.

The Add Value dialog appears.

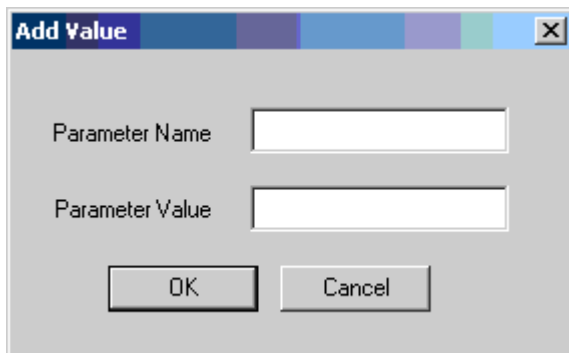

2. Enter the name in the **Parameter Name** field.
3. Enter the value in the **Parameter Value** field.
4. Click **OK**.
5. Click **Apply**.

---

---

**Note:** With Oracle Administration Assistant for Windows, you can add parameters only with a datatype of REG\_SZ. Use `regedt32` to add parameters with a datatype of REG\_EXPAND\_SZ, REG\_MULTI\_SZ, or REG\_DWORD.

---

---

## Editing Oracle Home Parameters

To change the default SID, select the SID from the Default SID list in the Properties dialog. To edit one of the other parameters:

1. Select the parameter in the **Other Settings** list in the Properties dialog.
2. Click **Edit**.



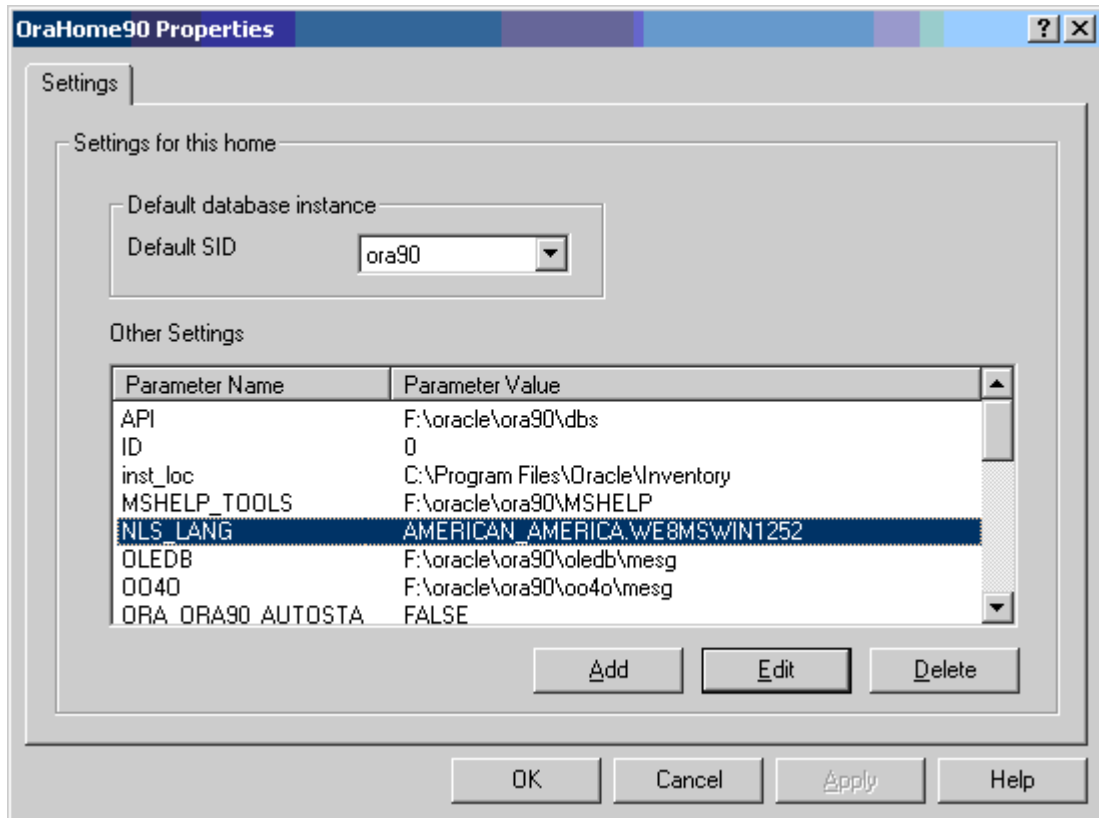

The Edit Value dialog appears.

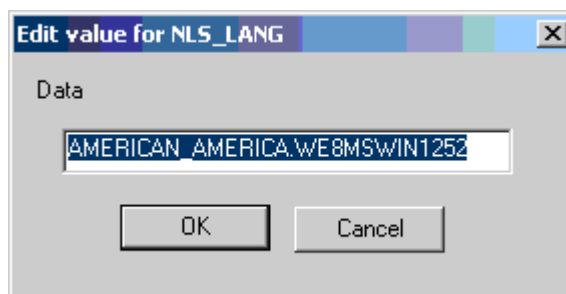

3. Modify the value.

4. Click **OK**.
5. Click **Apply**.

## Deleting Oracle Home Parameters

To delete an Oracle home parameter:

1. Select the parameter in the **Other Settings** list in the Properties dialog.
2. Click **Delete**.

## Modifying Oracle Counters for Windows Performance Monitor Parameters

Instead of using `regedt32` to modify Oracle Counters for Windows Performance Monitor's `Hostname`, `Password`, and `Username` parameters, you can use `OPERFCFGver` or Oracle Administration Assistant for Windows.

**See Also:** "[Parameters for Oracle Counters for Windows Performance Monitor](#)" on page 14-8 for more information about `Hostname`, `Password`, and `Username` parameters

## Using `OPERFCFGver`

`OPERFCFGver` is an Oracle Database tool that you run from the command prompt. Use this syntax:

```
OPERFCFGver [-U username] [-P password] [-D TNS_Alias_for_database]
```

where:

- *username* is the `username` registry parameter value that Oracle Counters for Windows Performance Monitor uses to log in to the database. You must have a DBA **privilege** on this database.
- *password* is the `password` registry parameter value for *username*.
- *TNS\_Alias\_for\_database* is the **net service name** that Oracle Counters for Windows Performance Monitor uses to connect to the database. It affects the `Hostname` registry parameter. The net service name corresponds to the `SID` of the database that you want to monitor. The `-D` command can be specified without providing a database name value.

The `-U`, `-P`, and `-D` commands are all optional.

The following examples illustrate use of `OPERFCFGver`. First, to change username to `dba_admin`, password to `frank`, and leave database name at its current value, you would enter:

```
C:\> OPERFCFGver -U dba_admin -P frank
```

To change username to `dba_admin`, password to `frank`, and database name to `prod`, you would enter:

```
C:\> OPERFCFGver -U dba_admin -P frank -D prod
```

To change password to `frank` for the current username and database name, you would enter:

```
C:\> OPERFCFGver -P frank
```

In the final example, you change `Hostname` to a blank value, causing Oracle Counters for Windows Performance Monitor to connect to the default database on the computer. The current username and password must be valid user accounts on this database. Enter:

```
C:\> OPERFCFGver -D
```

## Using Oracle Administration Assistant for Windows

Oracle Counters for Windows Performance Monitor snap-in is part of Oracle Administration Assistant for Windows. You must have Microsoft Management Console on your computer in order to use this product.

To use Oracle Counters for Windows Performance Monitor snap-in:

1. Choose **Start > Programs > Oracle - HOME\_NAME > Configuration and Migration Tools > Administration Assistant for Windows**.

Oracle Administration Assistant for Windows starts.

2. Right-click **Performance Monitor**.

3. Click **Properties**.

The Performance Monitor Properties dialog appears.

4. Modify the text in the **Username**, **Password**, or **Database** fields.
5. Click **Apply**.



---

---

# Developing Applications for Windows

This chapter points to sources of information on developing applications for Windows and outlines a procedure for building and debugging external procedures.

This chapter contains these topics:

- [Finding Information on Application Development for Windows](#)
- [Developing Windows Applications](#)
- [Building External Procedures](#)
- [Debugging External Procedures](#)
- [Accessing Text Files with UTL\\_FILE](#)
- [Accessing Web Data with Intercartridge Exchange](#)

## Finding Information on Application Development for Windows

This section describes where to find information on developing applications specifically for Windows. These products are included on your Oracle Database Server CD-ROM.

### Java Enhancements

Oracle Database includes an integrated Java Virtual Machine and JServer Accelerator. Oracle Database also provides Oracle Java Database Connectivity (JDBC) Drivers. For more information, see *Oracle Database Java Developer's Guide*.

### XML Support

Oracle XML products include XML Developer's Kit (XDK) and Oracle XML SQL Utility. For more information:

- *Oracle XML Developer's Kit Programmer's Guide*
- *Oracle XML API Reference*

### Support for Internet Applications

Oracle Database support for internet applications includes Oracle Portal, which enables you to publish your data to the Web, Oracle HTTP Server, and PL/SQL Embedded Gateway, which offers **PL/SQL** procedures stored in Oracle Database that can be started through browsers. For more information:

- *Oracle Portal Installation Guide and Tutorial*
- *Oracle Enterprise Manager Grid Control Installation and Basic Configuration*

---

---

**Note:** Oracle Portal is available on a separate CD-ROM and included with Oracle Database for Windows.

---

---

### Application Wizards

Oracle Application Wizards allow developers to create database applications easily and quickly. They improve ease-of-use and reduce development time by generating much of the code for database connectivity. For information and downloads:

- <http://otn.oracle.com/software/>

## Oracle COM/COM+ Integration Feature

Oracle **COM/COM+** integration feature enables Java stored procedure developers and COM/COM+ developers to load COM+ objects from Oracle Database. For more information:

- *Oracle COM Automation Feature Developer's Guide*
- *Oracle Objects for OLE Developer's Guide*

## Oracle Services For Microsoft Transaction Server

Oracle Database for Windows permits enhanced deployment of COM/COM+ components in **Microsoft Transaction Server**, using Oracle Database as the resource manager. For more information:

- *Oracle Services for Microsoft Transaction Server Developer's Guide*

## Pro\*C/C++ and Pro\*COBOL Applications

- *Pro\*C/C++ Getting Started for Windows*
- *Pro\*COBOL Getting Started for Windows*
- *Oracle Call Interface Programmer's Guide*

## OLE DB

- *Oracle Provider for OLE DB Developer's Guide*

---

---

**Note:** Oracle ODBC Driver is updated on a regular basis. The newest release available is included on your CD-ROM. To download the latest release, visit: <http://otn.oracle.com/software/>  
Select Oracle ODBC Drivers from the Select a Utility or Driver list.

---

---

## Developing Windows Applications

Oracle Database provides a comprehensive set of APIs for Windows application developers and is well suited for both Java and COM/COM+ development. Oracle Database is integrated with Microsoft's development and deployment components, known as Windows Distributed interNet Applications Architecture (DNA). Performance and data access on Windows is enhanced in the following areas:

- Wide variety of data access methods for Windows and internet applications
- Wizards and assistants to speed application development
- COM/COM+/DCOM integration through two APIs: Oracle Objects for OLE or Oracle Provider for OLE DB
- Microsoft Transaction Server integration: Oracle Services for Microsoft Transaction Server
- Platform extensions for internet application development

Developers are able to deploy their database applications more quickly by using the data access method with which they are familiar, rather than having to learn a new one. An Oracle Database server can communicate with Windows clients in a variety of methods, as described in [Table 15–1](#).

**Table 15–1 Oracle Data Access Methods**

Development Environment	Data Access Method
Java	JDBC SQLJ
COM/COM+	Oracle Objects for OLE (OO4O) Oracle Provider for OLE DB COM/COM+ Automation Feature

By using Oracle Database data access interfaces, developers can take advantage of specific Oracle Database features. These interfaces also offer flexibility and adherence to open standards.

Oracle COM/COM+ interfaces include the following features:

- OO4O can be used from any programming environment that supports Microsoft COM/COM+ technology, such as Visual Basic, Visual C++, VBA in Excel, Active Server Pages, PowerBuilder, Delphi, Internet Information Server (IIS), and Microsoft Transaction Server. OO4O is developed specifically for use with Oracle Database servers.
- Oracle Provider for OLE DB gives ActiveX Data Objects (ADO) developers high performance and efficient access to Oracle Database. A native OLE DB provider, it offers data access optimizations and access to Oracle-specific database features.



- COM/COM+ Automation Feature APIs make it easy for PL/SQL developers to incorporate COM/COM+ objects into their routines. An extension of this feature, Oracle COM/COM+ Integration, enables Java stored procedures and COM/COM+ developers to load COM/COM+ objects through OLE Automation or custom COM/COM+ interfaces in Oracle Database.

## Developing Internet Applications

Oracle Database provides Windows extensions for internet development, enabling access from any client, such as:

- Any browser
- Windows or Macintosh client
- FTP client
- Database client
- COM/COM+ client
- E-mail client

Oracle Database data access interfaces and development tools, along with Microsoft Transaction Server integration, can be used to build internet applications, as illustrated in [Figure 15-1, "Microsoft Transaction Server and Oracle Database Integration"](#).

**Figure 15–1 Microsoft Transaction Server and Oracle Database Integration**

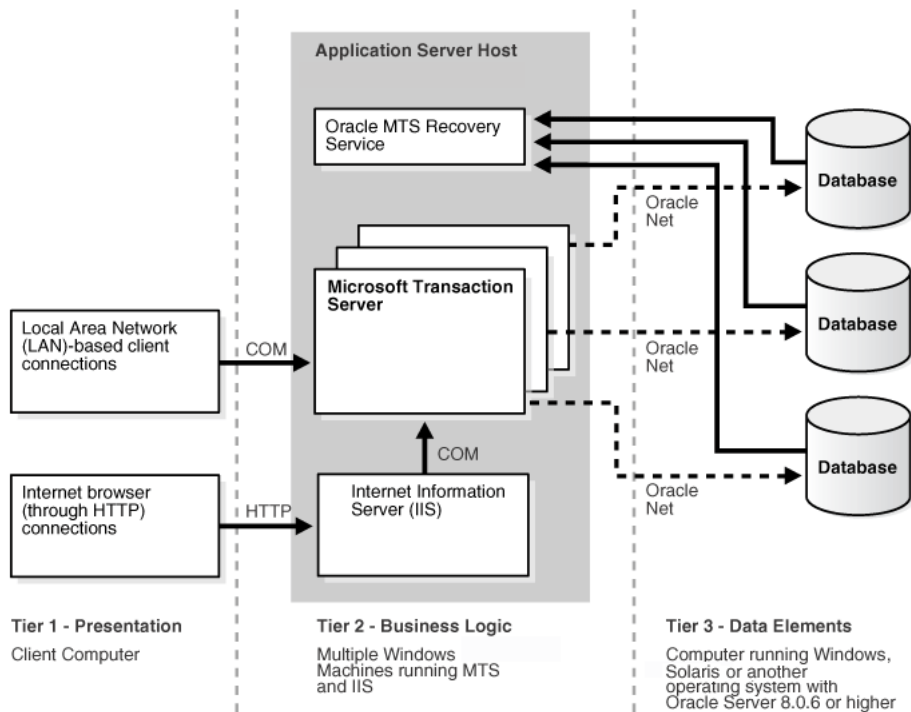

## Building External Procedures

This section describes how to create and use **external procedures** on Windows. The following files are located in `ORACLE_BASE\ORACLE_HOME\rdbms\extproc`:

- **extern.c** is the code example shown in "Writing an External Procedure"
- **make.bat** is the batch file that builds the **dynamic link library**
- **extern.sql** automates the instructions described in "Registering an External Procedure" and "Executing an External Procedure"

## External Procedures Overview

External procedures are functions written in a third-generation language (C, for example) and callable from within PL/SQL or SQL as if they were a PL/SQL routine or function. External procedures let you take advantage of strengths and capabilities of a third-generation programming language in a PL/SQL environment.

---

---

**Note:** Oracle Database also provides a special purpose interface, the call specification, that lets you call external procedures from other languages, as long as they are callable by C.

---

---

The main advantages of external procedures are:

- Performance, because some tasks are performed more efficiently in a third-generation language than in PL/SQL, which is better suited for SQL transaction processing
- Code re-usability, because dynamic link libraries (DLLs) can be called directly from PL/SQL programs on the server or in client tools such as Oracle Forms

You can use external procedures to perform specific processes:

- Solving scientific and engineering problems
- Analyzing data
- Controlling real-time devices and processes

---

---

**Caution:** Special security precautions are warranted when configuring a listener to handle external procedures. See ["Modifying Configuration of External Procedures for Higher Security"](#) on page C-4 and *Oracle Net Services Administrator's Guide* for more information.

---

---

To create and use an external procedure, perform the following sequential steps:

- [Installing and Configuring](#)
- [Writing an External Procedure](#)
- [Building a DLL](#)
- [Registering an External Procedure](#)
- [Executing an External Procedure](#)

---

---

**Note:** You must have a C compiler and linker installed on your system to build DLLs.

---

---

---

---

**Note:** You can combine the instructions described in the fourth and fifth tasks into one SQL script that automates the task of registering and executing your external procedure. See `ORACLE_BASE\ORACLE_HOME\rdbms\extproc\extern.sql` for an example of a SQL script that combines these steps.

---

---

## Installing and Configuring

This section describes installation and configuration of Oracle Database and [Oracle Net](#).

### Installing Oracle Database

Follow the steps in *Oracle Database Installation Guide for Windows* to install these products on your Windows server:

- Oracle Database Enterprise Edition, Oracle Database Standard Edition, or Oracle Database Personal Edition. Each type contains PL/SQL, from which external procedures are called, and the PL/SQL external procedure program (EXTPROC), which runs external procedures.
- Oracle Net Services
- [Oracle Protocol Support](#)

### Configuring Oracle Net Services

During database server installation, Oracle Net Configuration Assistant configures `listener.ora` and `tnsnames.ora` files for external procedure calls.

When an application calls an external procedure, Oracle Net Listener starts an external procedure agent called EXTPROC. Using a network connection established by the listener, the application passes the following information to EXTPROC:

- DLL name
- External procedure name
- Parameters (if necessary)

EXTPROC then loads the DLL, runs the external procedure, and passes back any values returned by the external procedure.

If you overwrite default `listener.ora` and `tnsnames.ora` files, then you must manually configure the following files for the external procedure behavior described previously to occur:

- `ORACLE_BASE\ORACLE_HOME\network\admin\listener.ora`
- `ORACLE_BASE\ORACLE_HOME\network\admin\tnsnames.ora`

---



---

**Caution:** Additional security may be required for the listener in a production environment. See *Oracle Net Services Administrator's Guide* for more information.

---



---

## Writing an External Procedure

Using a third-generation programming language, you can write functions to be built into DLLs and started by EXTPROC. The following is a simple Microsoft Visual C++ example of an external procedure:

---



---

**Note:** Because external procedures are built into DLLs, they must be explicitly exported. In this example, the `DLLEXPORT` storage class modifier exports the function `FIND_MAX` from a dynamic link library.

---



---

```
#include <windows.h>
#define NullValue -1
/*
   This function tests if x is at least as big as y.
*/
long __declspec(dllexport) find_max(long x,
    short x_indicator,
    long y,
    short y_indicator,
    short *ret_indicator)
{
    /* It can be tricky to debug DLL's that are being called by a process
       that is spawned only when needed, as in this case.
       Therefore try using the DebugBreak(); command.
       This will start your debugger. Uncomment the line with DebugBreak();
       in it and you can step right into your code.
    */
}
```

```
*/
/* DebugBreak(); */

/* First check to see if you have any nulls. */
/* Just return a null if either x or y is null. */

if ( x_indicator==NullValue || y_indicator==NullValue) {
    *ret_indicator = NullValue;
    return(0);
} else {
    *ret_indicator = 0;          /* Signify that return value is not null. */
    if (x >= y) return x;
    else return y;
}
}
```

## Building a DLL

After writing your external procedure(s) in a third-generation programming language, use the appropriate compiler and linker to build a DLL, making sure to export the external procedures as noted previously. See your compiler and linker documentation for instructions on building a DLL and exporting its functions.

For the example in Task 2, you can build the external procedure `find_max` into a DLL called `extern.dll` by going to `ORACLE_BASE\ORACLE_HOME\rdbms\extproc` and typing `make`. After building the DLL, you can move it to any directory on your system.

Starting with Oracle9i release 2, however, the default behavior of `EXTPROC` is to load DLLs only from `ORACLE_HOME\bin` or `ORACLE_HOME\lib`. To load DLLs from other directories, you must set environment variable `EXTPROC_DLLS` to a colon (:) separated list of DLL names qualified with their complete paths. The preferred way to set this environment variable is through the `ENVS` parameter in `listener.ora`.

**See Also:** *Oracle Database Application Developer's Guide - Fundamentals* for more information on `EXTPROC`

## Registering an External Procedure

Once you have built a DLL containing your external procedure(s), you must register your external procedure(s) with Oracle Database:

To create a PL/SQL library to map to the DLL:

1. Start SQL\*Plus:

```
C:\> sqlplus
```

2. Connect to the database with appropriate **username** and password.
3. Create the PL/SQL library using the CREATE LIBRARY command:

```
SQL> CREATE LIBRARY externProcedures AS 'C:\oracle\ora92\rdbms\
extproc\extern.dll';
```

where `externProcedures` is an alias library (essentially a schema object in the database), and `C:\oracle\ora92\rdbms\extproc\extern.dll` is the path to the Windows operating system `dll` `extern.dll`. This example uses `C:\oracle` as your Oracle base and `\ora92` as your Oracle home.

---



---

**Note:** The DBA must grant the EXECUTE **privilege** on the PL/SQL library to users who want to call the library's external procedure from PL/SQL or SQL.

---



---

4. Create a PL/SQL program unit specification.

Do this by writing a PL/SQL subprogram that uses the EXTERNAL clause instead of declarations and a BEGIN . . . END block. The EXTERNAL clause is the interface between PL/SQL and the external procedure. The EXTERNAL clause identifies the following information about the external procedure:

- Name
- DLL alias
- Programming language in which it was written
- Calling standard (defaults to C if omitted)

In the following example, `externProcedures` is a DLL alias. You need the EXECUTE privilege for this library. The external procedure to call is `find_max`. If enclosed in double quotation marks, it becomes case-sensitive. The LANGUAGE term specifies the language in which the external procedure was written.

```
CREATE OR REPLACE FUNCTION PLS_MAX(
  x BINARY_INTEGER,
  y BINARY_INTEGER)
RETURN BINARY_INTEGER AS
  EXTERNAL LIBRARY externProcedures
```

```
NAME "find_max"
LANGUAGE C
PARAMETERS (
    x long,                -- stores value of x
    x_INDICATOR short,    -- used to determine if x is a NULL value
    y long,                -- stores value of y
    y_INDICATOR short     -- used to determine if y is a NULL value
RETURN INDICATOR short ); -- need to pass pointer to return value's
                           -- indicator variable to determine if NULL
-- This means that my function will be defined as:
-- long max(long x, short x_indicator,
-- long y, short y_indicator, short * ret_indicator)
```

## Executing an External Procedure

To run an external procedure, you must call the PL/SQL program unit (that is, the alias for the external function) that registered the external procedure. These calls can appear in any of the following:

- Anonymous blocks
- Standalone and packaged subprograms
- Methods of an object type
- Database triggers
- SQL statements (calls to packaged functions only)

In "[Registering an External Procedure](#)", PL/SQL function PLS\_MAX registered external procedure find\_max. Follow these steps to run find\_max:

1. Call PL/SQL function PLS\_MAX from a PL/SQL routine named UseIt:

```
SET SERVER OUTPUT ON
CREATE OR REPLACE PROCEDURE UseIt AS
    a integer;
    b integer;
    c integer;
BEGIN
    a := 1;
    b := 2;
    c := PLS_MAX(a,b);
    dbms_output.put_line('The maximum of '||a||' and '||b||' is '||c);
END;
```



2. Run the routine:

```
SQL> EXECUTE UseIt;
```

## Debugging External Procedures

Usually, when an external procedure fails, its C prototype is faulty. That is, the prototype does not match the one generated internally by PL/SQL. This can happen if you specify an incompatible C datatype. For example, to pass an OUT parameter of type REAL, you must specify `float *`. Specifying `float`, `double *`, or any other C datatype will result in a mismatch.

In such cases, you might get a `lost RPC connection to external procedure agent error`, which means that agent `extproc` terminated abnormally because the external procedure caused a core dump. To avoid errors when declaring C prototype parameters, refer to *Oracle Data Cartridge Developer's Guide*.

## Using Package DEBUG\_EXTPROC

To help you debug external procedures, PL/SQL provides utility package `DEBUG_EXTPROC`. To install the package, run script `dbgextp.sql`, which you can find in the PL/SQL demo directory.

To use the package, follow instructions in `dbgextp.sql`. Your Oracle Database account must have `EXECUTE` privileges on the package and `CREATE LIBRARY` privileges.

To debug external procedures:

1. From Windows Task Manager, in the Processes dialog, select **ExtProc.exe**.
2. Right click, and select **Debug**.
3. Click **OK** in the message window.

If you have built your DLL in a debug fashion with Microsoft Visual C++, then Visual C++ is activated.

4. In the Visual C++ window, select **Edit > Breakpoints**.

Use the breakpoint identified in `dbgextp.sql` in the PL/SQL demo directory.

**See Also:**

- *ORACLE\_BASE\ORACLE\_HOME\rdbms\extproc\readme.doc* (explains how to run the sample and provides debugging advice)
- *PL/SQL User's Guide and Reference*
- *Oracle Database Java Developer's Guide*
- "Calling External Procedures" in *Oracle Database Application Developer's Guide - Fundamentals*
- *Oracle Data Cartridge Developer's Guide*

## Accessing Text Files with UTL\_FILE

Package `UTL_FILE` allows your PL/SQL programs to read and write operating system text files. It provides a restricted version of standard operating system stream file I/O, including `open`, `put`, `get`, and `close` operations. When you want to read or write a text file, you call the function `fopen`, which returns a file handle for use in subsequent procedure calls. For example, the procedure `put_line` writes a text string and line terminator to an open file, and the procedure `get_line` reads a line of text from an open file into an output buffer.

**See Also:** *PL/SQL Packages and Types Reference* for more information on `UTL_FILE`

`FSEEK`, a `UTL_FILE` subprogram, adjusts the file pointer forward or backward within the file by the number of bytes specified. In order for `UTL_FILE.FSEEK` to work correctly, the lines in the file must have platform-specific line terminator characters. On Windows platforms the correct line terminator characters are `<CR><LF>`.

## Accessing Web Data with Intercartridge Exchange

This section discusses the following topics:

- [Configuring Intercartridge Exchange](#)
- [Using Intercartridge Exchange](#)
- [UTL\\_HTTP Exception Conditions](#)
- [Exception Conditions and Error Messages](#)

## Configuring Intercartridge Exchange

You must add a parameter to the [registry](#) before using Intercartridge Exchange.

1. Start Registry Editor from the command prompt:

```
C:\> regedt32
```

The Registry Editor window appears.

---

---

**Note:** For another way to configure your registry, see "[Modifying a Registry Value with regedt32](#)" on page 14-11

---

---

2. Add HTTP\_PROXY to the registry subkey of the Oracle home directory that you are using. The location of this parameter is determined by how many Oracle home directories are on your computer. If you have only one home directory, add HTTP\_PROXY to

```
HKEY_LOCAL_MACHINE\SOFTWARE\ORACLE\HOME0.
```

If you have more than one home directory, add it to

```
HKEY_LOCAL_MACHINE\SOFTWARE\ORACLE\KEY_HOME_NAME
```

3. Choose **Add Value** from the **Edit** menu.

The Add Value dialog appears.

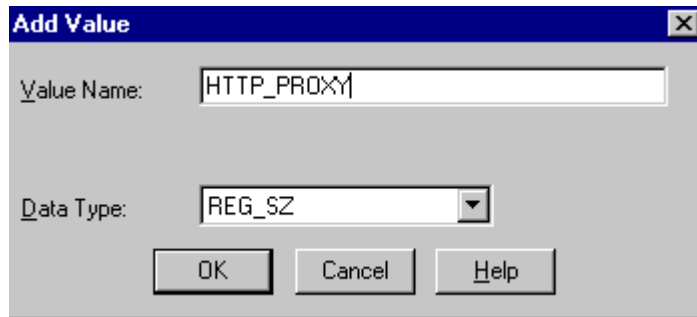

4. Type HTTP\_PROXY in the **Value Name** field and REG\_SZ in the **Data Type** field.
5. Click **OK**.
6. Type `www-proxy.your-site` in the **String** field.

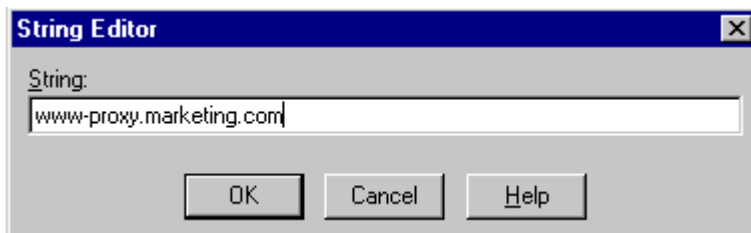

In this example, the Web site is `marketing.com`. You will enter the domain name of your actual Web site.

## Using Intercartridge Exchange

Intercartridge Exchange enables you to use a stored package called `UTL_HTTP` to make Hypertext Transfer Protocol (HTTP) calls from PL/SQL, SQL, and SQL\*Plus statements.

`UTL_HTTP` can do both of the following:

- Access data on the Internet
- Call Oracle Web Application Server cartridges

`UTL_HTTP` contains two similar entry points, known as packaged functions, that turn PL/SQL and SQL statements into HTTP callouts:

- `UTL_HTTP.REQUEST`
- `UTL_HTTP.REQUEST_PIECES`

Both packaged functions perform the following tasks:

- Take a string universal resource locator (URL) of a site
- Contact that site
- Return data (typically HTML) obtained from that site

Declarations to use with both packaged functions are described in the following subsections.

## Packaged Function UTL\_HTTP.REQUEST

UTL\_HTTP.REQUEST uses a URL as its argument and returns up to the first 2000 bytes of data retrieved from that URL. Specify UTL\_HTTP.REQUEST as follows:

```
FUNCTION REQUEST (URL IN VARCHAR2) RETURN VARCHAR2;
```

To use UTL\_HTTP.REQUEST from SQL\*Plus, enter:

```
SQL> SELECT UTL_HTTP.REQUEST('HTTP://WWW.ORACLE.COM/') FROM DUAL;
```

which returns:

```
UTL_HTTP.REQUEST('HTTP://WWW.ORACLE.COM/')
-----
<html>
<head><title>Oracle Home Page</title>
<!--changed Jan. 16, 19
1 row selected.
```

## Packaged Function UTL\_HTTP.REQUEST\_PIECES

UTL\_HTTP.REQUEST\_PIECES uses a URL as its argument and returns a PL/SQL table of 2000 bytes of data retrieved from the given URL. The final element can be shorter than 2000 characters. The UTL\_HTTP.REQUEST\_PIECES return type is a PL/SQL table of type UTL\_HTTP.HTML\_PIECES.

UTL\_HTTP.REQUEST\_PIECES, which uses type UTL\_HTTP.HTML\_PIECES, is specified as:

```
type html_pieces is table of varchar2(2000) index by binary_integer;
function request_pieces (url in varchar2,
    max_pieces natural default 32767)
return html_pieces;
```

A call to REQUEST\_PIECES can look like this example. Note the use of PL/SQL table method COUNT to discover the number of pieces returned; it can be zero or more:

```
declare pieces utl_http.html_pieces;
begin
    pieces := utl_http.request_pieces('http://www.oracle.com/');
    for i in 1 .. pieces.count loop
        ... -- process each piece
    end loop;
end;
```

The second argument to `UTL_HTTP.REQUEST_PIECES` (`MAX_PIECES`) is optional. `MAX_PIECES` is the maximum number of pieces (each 2000 characters in length, except for the last, which can be shorter) that `UTL_HTTP.REQUEST_PIECES` returns. If provided, that argument is usually a positive integer.

For example, the following block retrieves up to 100 pieces of data (each 2000 bytes, except perhaps the last) from the URL. The block prints the number of pieces retrieved and the total length, in bytes, of the data retrieved.

```
set serveroutput on

declare
  x utl_http.html_pieces;
begin
  x := utl_http.request_pieces('http://www.oracle.com/', 100);
  dbms_output.put_line(x.count || ' pieces were retrieved. ');
  dbms_output.put_line('with total length ');
  if x.count < 1
  then dbms_output.put_line('0');
  else dbms_output.put_line
    ((2000 * (x.count - 1)) + length(x(x.count)));
  end if;
end;
```

```
which displays:
Statement processed.
4 pieces were retrieved.
with total length
7687
```

Elements of the PL/SQL table returned by `UTL_HTTP.REQUEST_PIECES` are successive pieces of data obtained from the HTTP request to that URL.

## UTL\_HTTP Exception Conditions

This subsection describes exceptions (errors) that can be raised by packaged functions `UTL_HTTP.REQUEST` and `UTL_HTTP.REQUEST_PIECES`.

### UTL\_HTTP.REQUEST

`PRAGMA RESTRICT_REFERENCES` enables display of exceptions:

```
create or replace package utl_http is
function request (url in varchar2) return varchar2;
pragma restrict_references (request, wnds, rnds, wnps, rnps);
```

## UTL\_HTTP.REQUEST\_PIECES

PRAGMA RESTRICT\_REFERENCES enables display of exceptions:

```
create or replace package utl_http is
type html_pieces is table of varchar2(2000) index by binary_integer;
function request_pieces (url in varchar2,
    max_pieces natural default 32767)
return html_pieces;
pragma restrict_references (request_pieces, wnds, rnds, wnps, rnps);
```

## Exception Conditions and Error Messages

If initialization of the HTTP callout subsystem fails for environmental reasons (such as lack of available memory), then exception `UTL_HTTP.INIT_FAILED` is raised:

```
init_failed exception;
```

If the HTTP call fails due to failure of the HTTP daemon or because the argument to `REQUEST` or `REQUEST_PIECES` cannot be interpreted as a URL (because it is `NULL` or has non-HTTP syntax), then exception `UTL_HTTP.REQUEST_FAILED` is raised:

```
request_failed exception;
```

Unless explicitly caught by an exception handler, these first two exceptions are reported by a generic message that shows them as "user-defined" exceptions, even though they are defined in this system package:

```
ORA-06510: PL/SQL: unhandled user-defined exception
```

If any other exception is raised during processing of the HTTP request (for example, an out-of-memory error), then function `UTL_HTTP.REQUEST` or `UTL_HTTP.REQUEST_PIECES` reraises that exception.

If no response is received from a request to the given URL, because the function made no contact with a site corresponding to that URL, then a formatted HTML error message may be returned:

```
<HTML>
<HEAD>
<TITLE>Error Message</TITLE>
</HEAD>
<BODY>
<H1>Fatal Error 500</H1>
Can't Access Document: http://home.nothing.comm.
<P>
<B>Reason:</B> Can't locate remote host: home.nothing.comm.
```

```
<P>
<P><HR>
<ADDRESS><A HREF="http://www.w3.org">
CERN-HTTPD3.0A</A></ADDRESS>
</BODY>
</HTML>
```

If `UTL_HTTP.REQUEST` or `UTL_HTTP.REQUEST_PIECES` raises an exception or returns an HTML-formatted error message, yet you believe that the URL argument is correct, try contacting that same URL with a browser to verify network availability from your computer.



---

---

# Getting Started with Your Documentation

Your Oracle Database documentation set is provided in both HTML and PDF formats on a CD included in your CD Pack. Use this CD to browse the library from the CD or copy files directly to a local system.

The library includes a Web-based search tool that enables you to search for information about a particular product, parameter, file name, procedure, error message, or other area of interest. The search tool also makes it possible to construct a "virtual book" drawn from the complete documentation library, but consisting only of topics and procedures relevant to your needs. The library also includes a comprehensive Master Index, as well as lists of SQL and PL/SQL keywords, initialization parameters, catalog views, and data dictionary views.

Instructions for installing the library and viewing its contents are in three README files at the root level of the documentation CD-ROMs:

- README.htm
- README.pdf
- README.txt

---

---

**Note:** The `readme.txt` file contains UNIX line breaks. If you simply double-click it, it will open in Notepad by default, and Notepad does not recognize UNIX line breaks. Use `write.exe` or `edit.com` instead.

---

---

The contents of the three files are identical; only the format differs.

The following guides are not included on the Oracle Database Online Documentation Library CD-ROM for Windows:

- 
- *Oracle Database Installation Guide for Windows and Oracle Database Release Notes for Windows*

To access these documents before installation, open `start_here.htm` in the `\doc` directory on the component CD-ROM. To access these documents after installation, choose **Start > Programs > Oracle - HOME\_NAME > Release Documentation** or open `start_here.htm` in the `ORACLE_BASE\ORACLE_HOME\doc` directory on your hard drive.

- Oracle Migration Workbench documentation

---

---

**Note:** Oracle Migration Workbench is available only at OTN. See <http://otn.oracle.com/tech/migration/content.html>

---

---

- Oracle Fail Safe documentation

This document is on the Oracle Fail Safe product CD-ROM.

---

---

**Note:** Oracle Fail Safe is not supported on Windows XP.

---

---

---

---

## Storing Tablespaces on Raw Partitions

This appendix describes how to configure your system to store datafiles for a **tablespace** on **raw partitions**.

This appendix contains these topics:

- [Raw Partition Overview](#)
- [Creating a Tablespace in a Raw Partition](#)

---

---

**Note:** Oracle Real Application Clusters require additional configuration tools. See *Oracle Real Application Clusters Installation and Configuration Guide* for information on creating logical partitions and assigning symbolic links. Do not use this appendix to create partitions for Oracle Real Application Clusters.

---

---

## Raw Partition Overview

Datafiles for tablespaces can be stored on a file system or on raw partitions. A raw partition is a portion of a physical disk that is accessed at the lowest possible level. Input/output (I/O) to a raw partition offers approximately a 5% to 10% performance improvement over I/O to a partition with a file system on it.

To create a raw partition, you must first generate an extended partition and a logical partition. An extended partition points to raw space on the disk that can be assigned multiple logical partitions for database files. An extended partition also avoids the four-partition limit by letting you define large numbers of logical partitions to accommodate applications using the Oracle Database server. Logical partitions can then be given symbolic link names to free up drive letters.

## Physical Disk

A physical disk represents the entire disk and points to the following:

```
\Device\Harddiskx\Partition0
```

Symbolic link name `\\.\PhysicalDrivex` is automatically defined by Windows for every hard disk in the computer. For example, a computer with three hard disks will have the following symbolic links:

```
\\.\PhysicalDrive0  
\\.\PhysicalDrive1  
\\.\PhysicalDrive2
```

Internally, these names expand to the following:

```
\\.\PhysicalDrive0 =\Device\Harddisk0\Partition0  
\\.\PhysicalDrive1 =\Device\Harddisk1\Partition0  
\\.\PhysicalDrive2 =\Device\Harddisk2\Partition0
```

`Partition0` is special, because it represents the entire physical disk regardless of any partitioning scheme on that disk. Windows writes a signature on the first block of all disks it recognizes. To avoid overwriting that block, Oracle Database skips the first block of a physical raw partition that is used for an Oracle Database datafile.

---

---

**Note:** Although you can use physical disks, Oracle recommends that you use logical partitions.

---

---

## Logical Partition

Logical partitions point to drives other than `\Device\Harddiskx\Partition0`. They are initially assigned names with drive letters (`\\.\drive_letter:`) and typically re-assigned symbolic link names (`\\.\symbolic link name`). For example, `\\.\D:` may be assigned a symbolic link name of `\\.\ACCOUNTING_1`. Regardless of whether a drive letter or symbolic link name is used, logical partitions are defined to represent a specific partition in a disk rather than the entire disk. Internally, these names can expand to:

```
\\.\D:= \Device\Harddisk2\Partition1
\\.\ACCOUNTING_1= \Device\Harddisk3\Partition2
```

---



---

**Note:** Oracle Database does not skip the first block of a logical raw partition used for an Oracle Database datafile.

---



---

## Physical Disk and Logical Partition Considerations

Consider the following when deciding which raw partition to use:

- Physical disks are automatically defined by Windows to represent the entire disk, and should never be defined by the user.
- Logical partitions must be defined by the user to represent a specific partition in a disk. These partitions should be logical partitions or drives contained in an extended partition. They should never be defined as `Partition0`.
- Using an entire disk (`Partition0`) for an Oracle Database datafile and using a partition that occupies the entire disk for an Oracle Database datafile are not the same thing. Even when a partition occupies the entire disk, there is still a small space on the disk that is not part of the partition.
- If you are using an entire disk for an Oracle Database datafile (`Partition0`), then use the pre-defined physical raw names that Windows provides.
- If you are using a specific partition and it occupies the entire disk, then use a logical partition.
- If you are using a specific partition created with Windows disk-management tools, then define and use a symbolic link name rather than a logical partition number (even if it occupies the entire disk).

---

---

**Note:** For both physical and logical raw conventions, use `OCOPY` to transfer the contents of a raw partition to a standard file system for backup purposes.

---

---

## Compatibility Issues

You can create logical partitions, but define physical disk convention names for them. For example:

```
\\.\PhysicalDriveACCOUNTING_1 = \Device\Harddisk2\Partition1  
\\.\PhysicalDriveACCOUNTING_2 = \Device\Harddisk3\Partition1
```

Oracle Database then handles datafiles using the physical disk convention even though it really is a logical partition. This will not cause any data corruption or loss as long as you continue to use physical disk naming conventions. Oracle recommends that you convert to the logical partition at your earliest convenience.

You can also create logical names representing `Partition0`, but this is definitely not recommended. For example:

```
\\.\ACCOUNTING_1 = \Device\Harddisk1\Partition0
```

This poses severe problems, because Disk Management typically writes a signature into the first block of every disk, and consequently may overwrite a portion of the datafile header. It can also cause data loss. Never use `Partition0` with the logical partition convention.

Physical and logical partition conventions are not compatible with one another because of the extra block that is skipped for physical raw conventions. This also means you cannot simply use `OCOPY` to copy from a physical disk to a logical partition, because contents of these partitions are incompatible.

To convert from a physical convention to a logical convention, you must:

1. Perform a full database export to a (local) file system.
2. Create logical partitions and define logical names for these partitions.
3. Recreate the database by using the new logical partitions.
4. Perform the full database import to the newly-created database.

If your database installation uses physical disk conventions with logical partitions, Oracle recommends converting to the logical partition conventions at your earliest convenience, using the preceding steps.

**See Also:** Your Windows documentation for information on creating extended and logical partitions.

## Creating a Tablespace in a Raw Partition

To create a tablespace using a datafile located in a raw partition:

1. Start SQL\*Plus:

```
C:\> sqlplus
```

2. Connect to the Oracle Database repository database:

```
Enter user-name: SYSTEM/password
```

where *password* for user account **SYSTEM** is **MANAGER** by default. If you have changed this password, substitute the correct password for **MANAGER**.

3. Create the tablespace:

```
SQL> CREATE TABLESPACE tablespace DATAFILE '\\.\datafile' SIZE xm;
```

where:

- *tablespace* is the tablespace name
- '\\.\' is the drive letter or symbolic link name assigned to the raw partition
- *x* is the tablespace size in megabytes (Twenty megabytes is a good starting place.)

For example, to create a tablespace named `accounting_1` that was assigned a symbolic link name of `accounting_1`, enter the following:

```
SQL> CREATE TABLESPACE accounting_1 DATAFILE '\\.\accounting_1' SIZE 502M;
```

---

---

**Note:** If you are creating a database with the SQL script, modify datafiles that are stored on raw partitions with a naming convention of '\\.\drive\_letter:' or '\\.\symbolic link name.

---

---





---

---

# Oracle Net Services Configuration on Windows

This appendix describes Oracle Net Services configuration for Windows. For more generic information on Oracle Net Services configuration, see *Oracle Net Services Administrator's Guide*.

This appendix contains these topics:

- [Understanding Oracle Net Services Registry Parameters and Subkeys](#)
- [Listener Requirements](#)
- [Understanding Optional Configuration Parameters](#)
- [Advanced Network Configuration](#)

## Understanding Oracle Net Services Registry Parameters and Subkeys

The registry contains entries for Oracle Net Services parameters and subkeys. To successfully add or modify Oracle Net Services configuration parameters, you must understand where they are located and the rules that apply to them.

### Oracle Net Service Subkeys

HKEY\_LOCAL\_MACHINE\SYSTEM\CurrentControlSet\Services contains subkeys that correspond to services. Depending on what is installed, your Oracle Net Services consist of all or a subset of the following:

- OracleHOME\_NAMEClientCache
- OracleHOME\_NAMECMAdmin
- OracleHOME\_NAMECMan
- OracleHOME\_NAMETNSListener

Each service subkey contains the parameters shown in [Table C-1](#).

**Table C-1 Service Subkey Parameters**

Parameter	Description
DisplayName	Specifies service name.
ImagePath	Specifies fully qualified path name of executable invoked by service and any command line arguments passed to executable at runtime.
ObjectName	Specifies logon user account and computer to which service should log on.

### Listener Requirements

In Oracle Database 10g, the listener is set to start automatically at system restart. If you intend to use only the listener for all of your databases, ensure that only the Windows service for the listener, as listed in the Control Panel, is set to start automatically.

Oracle usually recommends that you only have a single net listener service running on a Windows computer at any one time. This single listener can support multiple databases. If you need to have two different net listener services running on a Windows computer at the same time, make sure that they are configured to listen on different TCP/IP port numbers.

If the same IP address and port are used for different listeners, you might expect that the second and subsequent listeners would fail to bind. Instead, Windows allows them all to listen on the same IP address and port, resulting in unexpected behavior of the listeners. This is a suspected Windows operating system problem with TCP/IP and has been reported to Microsoft.

## Understanding Optional Configuration Parameters

You can use the following parameters on Windows:

- [LOCAL](#)
- [TNS\\_ADMIN](#)
- [USE\\_SHARED\\_SOCKET](#)

Oracle Net Service first checks for the parameters as environment variables, and uses the values defined. If environment variables are not defined, it searches for these parameters in the registry.

### LOCAL

You can use parameter `LOCAL` to connect to Oracle Database without specifying a connect identifier in the connect string. The value of parameter `LOCAL` is any connect identifier, such as a net service name. For example, if parameter `LOCAL` is specified as `finance`, you can connect to a database from SQL\*Plus with:

```
SQL> CONNECT scott/tiger
```

rather than

```
SQL> CONNECT scott/tiger@finance
```

Oracle Net checks if `LOCAL` is defined as an environment variable or as a parameter in the registry, and uses `finance` as the service name. If it exists, Oracle Net connects.

### TNS\_ADMIN

You can add parameter `TNS_ADMIN` to change the directory path of Oracle Net Services configuration files from the default location of `ORACLE_HOME\network\admin`. For example, if you set `TNS_ADMIN` to `ORACLE_BASE\ORACLE_HOME\test\admin`, the configuration files are used from `ORACLE_BASE\ORACLE_HOME\test\admin`.

## USE\_SHARED\_SOCKET

You can set parameter `USE_SHARED_SOCKET` to `true` to enable use of shared sockets. If this parameter is set to `true`, the network listener passes the socket descriptor for client connections to the database thread. As a result, the client does not need to establish a new connection to the database thread and database connection time improves. Also, all database connections share the port number used by the network listener, which can be useful if you are setting up third-party proxy servers.

This parameter only works in dedicated server mode in a TCP/IP environment. If this parameter is set, you cannot use the 9.0 listener to spawn Oracle7 release 7.x databases. To spawn a dedicated server for an instance of Oracle Database not associated with the same Oracle home as the listener and have shared socket enabled, you must also set parameter `USE_SHARED_SOCKET` for both Oracle homes.

## Advanced Network Configuration

The following sections describe advanced configuration procedures specifically for Oracle Net Services on Windows operating systems.

### Configuring Authentication Method

Oracle Net Services provides authentication methods for Windows operating systems using Windows Native Authentication.

### Configuring Security for Named Pipes Protocol

The network listener service may be unable to open the Named Pipe created by Oracle Names unless service `OracleHOME_NAME_TNSListener` has a valid user ID and password associated with it.

**See Also:** Your Windows documentation for instructions on setting up network listener permissions

### Modifying Configuration of External Procedures for Higher Security

This section supplements generic information provided in *Oracle Net Services Administrator's Guide* to configure a listener on Windows operating systems to exclusively handle external procedures. For a higher level of security, you are instructed to start the listener for external procedures from a user account with

lower privileges than the `oracle` user. For Windows operating systems, this requires that you change the user account from `LocalSystem` to a local, unprivileged user for the `OracleHOME_NAMETNSListenerextproc_listener_name` service.

---

---

**Note:** The following instructions assume that you have performed steps 1 through 5 in the section "Modifying Configuration of External Procedures for Higher Security" in *Oracle Net Services Administrator's Guide*.

---

---

To change the listener account:

1. Create a new user account and grant it Log on as a Service privilege.

---

---

**Note:** Ensure that this user account does not have general access to files owned by `oracle`. Specifically, this user should not have permission to read or write to database files or to the Oracle Database server address space. In addition, this user should have read access to the `listener.ora` file, but must not have write access to it.

---

---

2. Stop service `OracleHOME_NAMETNSListenerextproc_listener_name`.

**See Also:** Your Windows documentation for instructions on accessing the Services dialog and stopping services

---

---

**Note:** If the `OracleHOME_NAMETNSListenerextproc_listener_name` service does not exist, issue the following command from the command prompt:

```
lsnrctl start extproc_listener_name
```

This creates the `OracleHOME_NAMETNSListenerextproc_listener_name` service. When you return to the list of services, stop this service before proceeding to the next step of this procedure.

---

---

3. Select `OracleHOME_NAMETNSListenerextproc_listener_name` service in the Services dialog and then display the properties of the service.

4. Select **This Account** and enter the username and password.
5. Start the listener by clicking **Start**. You must start the listener in this way because you cannot use the Listener Control utility to start the listener running as an unprivileged local user.

---

---

**Note:** You can also use `NET START OracleHOME_NAMETNSListenerextproc_listener_name` to start the listener from the command prompt. Running the listener with lower privileges prevents you from using Listener Control utility `SET` commands to alter the configuration of this listener in file `listener.ora`. You can perform other administrative tasks on this listener with the Listener Control utility, including stopping the listener. Oracle recommends that you complete `listener.ora` file configuration prior to running the listener.

---

---

---

---

## Error Messages on Windows

This appendix lists error messages, causes, and corrective actions that are specific to operation of Oracle Database for Windows. This appendix also includes database connection issues.

This appendix contains these topics:

- [ORA-09275: CONNECT INTERNAL No Longer Supported](#)
- [OSD-04000 to OSD-04599: Windows-Specific Oracle Database Messages](#)
- [DIM-00000 to DIM-00039: ORADIM Command Syntax Errors](#)
- [Database Connection Issues](#)

---

---

**Note:** The `ora.hlp` file, which was shipped in previous releases, is no longer available. See this Appendix, *Oracle Database Error Messages*, and *Oracle Enterprise Manager Messages Manual* for information on error messages.

---

---

## ORA-09275: CONNECT INTERNAL No Longer Supported

### ORA-09275

*Connect internal is not a valid DBA connection*

**Cause:** `CONNECT INTERNAL` is no longer supported.

**Action:** If NTS is enabled, you can connect to the database as `CONNECT / AS SYSDBA`. If NTS is not enabled, you can connect as `CONNECT SYS/password AS SYSDBA`. You can also connect as an existing user with the appropriate password.

## OSD-04000 to OSD-04599: Windows-Specific Oracle Database Messages

Error messages in this section are Oracle Database operating system-dependent (OSD) messages displayed in response to an error condition in Windows. Each message in this section triggers an Oracle Database error message.

Error messages appear first in summary tables consisting of error numbers and the corresponding error message. Following the tables is a more detailed discussion of errors, including causes and corrective actions.

- [File I/O Errors: OSD-04000 to OSD-04099](#)
- [Memory Errors: OSD-04100 to OSD-04199](#)
- [Process Errors: OSD-04200 to OSD-04299](#)
- [Loader Errors: OSD-04300 to OSD-04399](#)
- [Semaphore Errors: OSD-04400 to OSD-04499](#)
- [Miscellaneous Errors: OSD-04500 to OSD-04599](#)

---

<b>File I/O Errors:</b>	<b>OSD-04000 to OSD-04099</b>
4000	Logical block size mismatch
4001	Invalid logical block size
4002	Unable to open file
4003	Unable to read file header block
4004	Invalid file header
4005	SetFilePointer() failure, unable to read from file
4006	ReadFile() failure, unable to read from file

---



<b>File I/O Errors:</b>	<b>OSD-04000 to OSD-04099</b>
4007	Truncated read
4008	WriteFile() failure, unable to write to file
4009	Truncated write
4010	<create> option specified, file already exists
4011	GetFileInformationByHandle() failure, unable to obtain file info
4012	File size mismatch
4013	Unable to read line from file
4014	Unable to close file
4015	An asynchronous I/O request returned an error
4016	Error queuing an asynchronous I/O request
4017	Unable to open the specified RAW device
4018	Unable to access the specified directory or device
4019	Unable to set file pointer
4020	Unable to set eof file marker
4021	Unable to read file
4022	Unable to write file
4023	SleepEx() failure, unable to Sleep
4024	Unable to delete file
4025	Invalid question asked
4026	Invalid parameter passed

<b>Memory Errors:</b>	<b>OSD-04100 to OSD-04199</b>
4100	malloc() failure, unable to allocate memory
4101	Invalid SGA: SGA not initialized
4102	Unable to open/create file for shared memory object
4103	Unable to attach to SGA: SGA does not exist
4104	Unable to map shared memory (SGA) into the address space
4105	Shared memory (SGA) mapped to wrong address
4106	Unable to allocate memory with VirtualAlloc
4107	Unable to deallocate memory with VirtualFree
4108	Unable to protect memory with VirtualProtect

<b>Process Errors:</b>	<b>OSD-04200 to OSD-04299</b>
4200	Unable to begin another thread
4201	No pid structure supplied to spdcr()
4202	DosSetPriority() failure, unable to set process priority
4203	DosKillProcess() failure, unable to kill process
4204	Invalid pid
4205	CreateProcess() failure, unable to spawn process
4207	Invalid priority specified in CONFIG parameter ORACLE_PRIORITY
4208	OpenProcess() failure, unable to open process handle
4209	Incorrect or unknown background image name given to spdcr()
4210	Timeout waiting for thread semaphore
4211	Thread information not found
4212	Maximum number of ORACLE threads reached
4213	ORACLE thread unable to DuplicateHandle()
4214	ORACLE thread unable to CreateEvent()
4215	Bad function code supplied to ssthreadop
4216	Unable to find file handle for that thread
4217	Unable to retrieve system username for current user
4218	Cannot post thread
4219	Bad thread list semaphore
4221	Target thread is currently busy
4222	Unable to get the threads context
4223	Unable to set the threads context
4224	Unable to suspend the target thread
4225	Unable to resume the target thread

<b>Loader Errors:</b>	<b>OSD-04300 to OSD-04399</b>
4300	Unable to read complete record from datafile
4301	Record size too large
4302	Invalid record type, load options, or both

---

**Semaphore Errors: OSD-04400 to OSD-04499**

---

4400	Unable to acquire internal semaphore for process
4401	WaitForSingleObject() failure, unable to obtain semaphore

---

---

**Miscellaneous Errors: OSD-04500 to OSD-04599**

---

4500	Illegal option specified
4501	Internal buffer overflow
4502	Translations nested too deep
4503	Text contains no translatable elements
4505	stdin not responding
4506	Unable to spawn process via system()
4510	Operating system roles are not supported
4511	Unable to get date and time from the operating system
4512	Unable to translate the 'USERNAME' config.ora variable on server
4513	'remote_os_authent' init.ora variable not set to true
4514	The Windows Group name is too long for internal buffer
4515	This command is not implemented at this time

---

**File I/O Errors: OSD-04000 to OSD-04099****OSD-04000**

*Logical block size mismatch*

**Cause:** Database block size specified in [initialization parameter file](#) does not match block size of actual database files.

**Action:** Use matching logical block sizes.

**OSD-04001**

*Invalid logical block size*

**Cause:** Logical block size is not a multiple of 512 bytes, or it is too large.

**Action:** Change the value of DB\_BLOCK\_SIZE in the initialization parameter file.

**OSD-04002**

*Unable to open file*

**Cause:** Specified path or filename is invalid, or destination device is full. This error can also be caused by insufficient Windows file handles.

**Action:** Make sure path and file exist, and device has free space. If this fails, then increase number of Windows file handles.

**OSD-04003**

*Unable to read file header block*

**Cause:** Media has been damaged.

**Action:** Recover file, if necessary, and verify that Windows is functioning correctly.

**OSD-04004**

*Invalid file header*

**Cause:** File is damaged.

**Action:** Recover file.

**OSD-04005**

*SetFilePointer() failure, unable to read from file*

**Cause:** Unexpected return from Windows system service SetFilePointer().

**Action:** Check operating system error code and Windows documentation.

**OSD-04006**

*ReadFile() failure, unable to read from file*

**Cause:** Unexpected return from Windows system service ReadFile().

**Action:** Check operating system error code and Windows documentation.

**OSD-04007**

*Truncated read*

**Cause:** System encountered an unexpected end-of-file, which is due to damaged media.

**Action:** Verify that file is not damaged.

**OSD-04008**

*WriteFile() failure, unable to write to file*

**Cause:** Unexpected return from Windows system service WriteFile().

**Action:** Check operating system error code and Windows documentation.

**OSD-04009**

*Truncated write*

**Cause:** Destination device is full, or media is damaged.

**Action:** Verify that device has free space and that file is not damaged.

**OSD-04010**

*<create> option specified, file already exists*

**Cause:** File you attempted to create already exists.

**Action:** Delete existing file or use REUSE option in SQL statement.

**OSD-04011**

*GetFileInformationByHandle() failure, unable to obtain file info*

**Cause:** Unexpected return from Windows system service GetFileInformationByHandle().

**Action:** Check operating system error code and Windows documentation.

**OSD-04012**

*File size mismatch*

**Cause:** File to be re-used is either too large or too small.

**Action:** Specify correct file size or delete existing file.

**OSD-04013**

*Unable to read line from file*

**Cause:** This error is caused by an operating system error or by damaged media.

**Action:** Check operating system error code (if available) and Windows documentation. If no operating system error code is presented, then verify that media is not damaged.

**OSD-04014**

*Unable to close file*

**Cause:** Media has been damaged.

**Action:** Recover file, if necessary, and verify that Windows is functioning correctly.

**OSD-04015**

*Asynchronous I/O request returned an error*

**Cause:** Unexpected return from Windows system service.

**Action:** Check operating system error code and Windows documentation.

**OSD-04016**

*Error queuing an asynchronous I/O request*

**Cause:** Unexpected return from Windows system service.

**Action:** Check operating system error code and Windows documentation.

**OSD-04017**

*Unable to open the specified RAW device*

**Cause:** An invalid path or filename was specified, or device is full.

**Action:** Make sure file exists and device is not full; verify that operating system is functioning correctly.

**OSD-04018**

*Unable to access the specified directory or device*

**Cause:** An invalid path name was specified.

**Action:** Make sure directory or device exists and is accessible.

**OSD-04019**

*Unable to set file pointer*

**Cause:** This error is caused by an operating system error or by damaged media.

**Action:** Check operating system error code (if available) and Windows documentation. If no operating system error code is presented, then verify that media is not damaged.

**OSD-04020**

*Unable to set eof file marker*

**Cause:** This error is caused by an operating system error or by damaged media.

**Action:** Check operating system error code (if available) and Windows documentation. If no operating system error code is presented, then verify that media is not damaged.

**OSD-04021**

*Unable to read file*

**Cause:** This error is caused by an operating system error or by damaged media.

**Action:** Check operating system error code (if available) and Windows documentation. If no operating system error code is presented, then verify that media is not damaged.

**OSD-04022**

*Unable to write file*

**Cause:** This error is caused by an operating system error or by damaged media.

**Action:** Check operating system error code (if available) and Windows documentation. If no operating system error code is presented, then verify that media is not damaged.

**OSD-04023**

*SleepEx() failure, unable to Sleep*

**Cause:** Unexpected return from Windows system service.

**Action:** Check operating system error code and Windows documentation.

**OSD-04024**

*Unable to delete file*

**Cause:** This error is caused by an operating system error or by damaged media.

**Action:** Check operating system error code (if available) and Windows documentation. If no operating system error code is presented, then verify that media is not damaged.

**OSD-04025**

*Invalid question asked*

**Cause:** This is an internal error, not normally expected to occur.

**Action:** Contact Oracle Support Services.

**OSD-04026**

*Invalid parameter passed*

**Cause:** This is an internal error, not normally expected to occur.

**Action:** Contact Oracle Support Services.

## Memory Errors: OSD-04100 to OSD-04199

### OSD-04100

*Malloc() failure, unable to allocate memory*

**Cause:** Program is out of memory.

**Action:** Shut down all unnecessary processes or install more memory in the computer.

### OSD-04101

*Invalid SGA: SGA not initialized*

**Cause:** System Global Area (SGA) has been allocated but not initialized.

**Action:** Wait until STARTUP has completed before attempting to connect.

### OSD-04102

*Unable to open/create file for shared memory object*

**Cause:** Unexpected return from Windows system service CreateFile().

**Action:** Check operating system error code and Windows documentation.

### OSD-04103

*Unable to attach to SGA: SGA does not exist*

**Cause:** SGA does not exist.

**Action:** Start up an Oracle Database [instance](#).

### OSD-04104

*Unable to map shared memory (SGA) into the address space*

**Cause:** Unexpected return from Windows system service MapViewOfFileEx().

**Action:** Check operating system error code and Windows documentation.

### OSD-04105

*Shared memory (SGA) mapped to wrong address*

**Cause:** Unexpected return from Windows system service MapViewOfFileEx().

**Action:** Check operating system error code and Windows documentation.

### OSD-04106

*Unable to allocate memory with VirtualAlloc*

**Cause:** Program is out of memory.

**Action:** Shut down all unnecessary processes or install more memory in the computer.



**OSD-04107**

*Unable to deallocate memory with VirtualFree*

**Cause:** Unexpected return from Windows system service VirtualFree().

**Action:** Check operating system error code and Windows documentation.

**OSD-04108**

*Unable to protect memory with VirtualProtect*

**Cause:** Unexpected return from Windows system service VirtualProtect().

**Action:** Check operating system error code and Windows documentation.

**Process Errors: OSD-04200 to OSD-04299****OSD-04200**

*Unable to begin another thread*

**Cause:** Program has run out of system resources.

**Action:** Shut down all unnecessary processes; install more memory in the computer.

**OSD-04201**

*No pid structure supplied to spdcr()*

**Cause:** This is an internal error, not normally expected to occur.

**Action:** Contact Oracle Support Services.

**OSD-04202**

*DosSetPriority() failure, unable to set process priority*

**Cause:** Unexpected return from Windows system service DosSetPriority().

**Action:** Check operating system error code and Windows documentation.

**OSD-04203**

*DosKillProcess() failure, unable to kill process*

**Cause:** Unexpected return from Windows system service DosKillProcess().

**Action:** Check operating system error code and Windows documentation.

**OSD-04204**

*Invalid pid*

**Cause:** Process ID not recognized by system; process previously terminated.

**Action:** Verify that process ID is correct and that process is active.

**OSD-04205**

*CreateProcess() failure, unable to spawn process*

**Cause:** Unexpected return from Windows system service CreateProcess().

**Action:** Check operating system error code and Windows documentation.

**OSD-04207**

*Invalid priority specified in CONFIG parameter ORACLE\_PRIORITY*

**Cause:** Priority specified is invalid or out of range.

**Action:** Specify a valid setting for ORACLE\_PRIORITY.

**OSD-04208**

*OpenProcess() failure, unable to open process handle*

**Cause:** Unexpected return from Windows system service OpenProcess().

**Action:** Check operating system error code and Windows documentation.

**OSD-04209**

*Incorrect or unknown background image name given to spdcr()*

**Cause:** Unexpected background name given to spdcr().

**Action:** Contact Oracle Support Services.

**OSD-04210**

*Timeout waiting for thread semaphore*

**Cause:** An Oracle Database thread died holding the semaphore.

**Action:** Restart Oracle Database instance.

**OSD-04211**

*Thread information not found*

**Cause:** An Oracle Database thread died without deleting its information.

**Action:** Restart Oracle Database instance.

**OSD-04212**

*Maximum number of Oracle threads reached*

**Cause:** Maximum number of Oracle Database threads for the instance is reached.

**Action:** Wait until some connections exit before trying again.

**OSD-04213**

*Oracle thread unable to DuplicateHandle()*

**Cause:** This is an internal error, not normally expected to occur.

**Action:** Contact Oracle Support Services.

**OSD-04214**

*Oracle thread unable to CreateEvent()*

**Cause:** This is an internal error, not normally expected to occur.

**Action:** Contact Oracle Support Services.

**OSD-04215**

*Bad function code supplied to sstheadop*

**Cause:** This is an internal error, not normally expected to occur.

**Action:** Contact Oracle Support Services.

**OSD-04216**

*Unable to find file handle for that thread*

**Cause:** This is an internal error, not normally expected to occur.

**Action:** Contact Oracle Support Services.

**OSD-04217**

*Unable to retrieve system username for current user*

**Cause:** This is an internal error, not normally expected to occur.

**Action:** Contact Oracle Support Services.

**OSD-04218**

*Cannot post thread*

**Cause:** This is an internal error, not normally expected to occur.

**Action:** Contact Oracle Support Services.

**OSD-04219**

*Bad thread list semaphore*

**Cause:** This is an internal error, not normally expected to occur.

**Action:** Contact Oracle Support Services.

**OSD-04221**

*Target thread is currently busy*

**Cause:** Target thread is processing an Oracle Database utility command.

**Action:** Wait and resend command.

**OSD-04222**

*Unable to get the threads context*

**Cause:** Check operating system error code.

**Action:** Remedy operating system error.

**OSD-04223**

*Unable to set the threads context*

**Cause:** Check operating system error code.

**Action:** Remedy operating system error.

**OSD-04224**

*Unable to suspend the target thread*

**Cause:** Check operating system error code.

**Action:** Remedy operating system error.

**OSD-04225**

*Unable to resume the target thread*

**Cause:** Check operating system error code.

**Action:** Remedy operating system error.

## **Loader Errors: OSD-04300 to OSD-04399**

**OSD-04300**

*Unable to read complete record from datafile*

**Cause:** Datafile ended in the middle of a record. This error occurs when loading files with a fixed record length.

**Action:** Verify that datafile is of correct length and contains complete records.

**OSD-04301**

*Record size too large*

**Cause:** Specified record size is too large to load.

**Action:** Reduce record size and reload data.

**OSD-04302**

*Invalid record type, load options, or both*

**Cause:** Control file's Windows file processing options string contains an invalid option or keyword.

**Action:** Set Windows file processing options string to an acceptable value.

**Semaphore Errors: OSD-04400 to OSD-04499**

**OSD-04400**

*Unable to acquire internal semaphore for process*

**Cause:** Oracle Database has exceeded the maximum number of connections.

**Action:** Delete any unused connections and try again.

**OSD-04401**

*WaitForSingleObject() failure, unable to obtain semaphore*

**Cause:** Unexpected return from Windows system service WaitForSingleObject().

**Action:** Check operating system error code and Windows documentation.

**Miscellaneous Errors: OSD-04500 to OSD-04599**

**OSD-04500**

*Illegal option specified*

**Cause:** This is an internal error, not normally expected to occur.

**Action:** Contact Oracle Support Services.

**OSD-04501**

*Internal buffer overflow*

**Cause:** This is an internal error, not normally expected to occur.

**Action:** Contact Oracle Support Services.

**OSD-04502**

*Translations nested too deep*

**Cause:** Program encountered too many intermediate translations while attempting to translate a configuration variable.

**Action:** Simplify values of configuration parameters to include fewer intermediate translations.

**OSD-04503**

*Text contains no translatable elements*

**Cause:** Program cannot recognize variables in text to be translated.

**Action:** Check and, if necessary, correct text to be translated.

**OSD-04505**

*stdin not responding*

**Cause:** System is unable to receive input from standard input stream.

**Action:** Verify that process has access to an input device.

**OSD-04506**

*Unable to spawn process via system()*

**Cause:** System is out of memory or executable is invalid.

**Action:** Shut down unnecessary processes; install more memory in the computer. Verify name of executable.

**OSD-04510**

*Operating system roles are not supported*

**Cause:** An attempt was made to use an operating system role.

**Action:** Only use roles that were created 'IDENTIFIED BY PASSWORD' as opposed to 'IDENTIFIED EXTERNALLY'.

**OSD-04511**

*Unable to get date and time from the operating system*

**Cause:** Unexpected return from GetLocalTime() call.

**Action:** Verify that system time is correct on the computer.

**OSD-04512**

*Unable to translate the 'USERNAME' config.ora variable on server*

**Cause:** 'USERNAME' configuration parameter variable on host is not properly set.

**Action:** Verify 'USERNAME' variable is set.

**OSD-04513**

*'remote\_os\_authent' init.ora variable not set to TRUE*

**Cause:** For remote operating system logon to function, 'REMOTE\_OS\_AUTHENT' parameter must be set to TRUE.

**Action:** Shut down and start up instance with 'REMOTE\_OS\_AUTHENT = TRUE' in initialization parameter file.

**OSD-04514**

*The Windows Group name is too long for internal buffer*

**Cause:** Windows Group name is too long.

**Action:** Use a shorter Windows group name.

## DIM-00000 to DIM-00039: ORADIM Command Syntax Errors

ORADIM is a command-line tool for starting and stopping database instances that is only available on Oracle Database for Windows. It is not available on any other platform.

Oradim Errors	DIM-0000 to DIM-0039
00000	ORADIM completed with no errors
00001	ORADIM: <command> [options]. Refer to manual.
00002	The specified command was invalid.
00003	An argument is missing for the parameter
00004	SID or service name was not specified.
00005	SID with more than 64 characters specified.
00006	Missing SID
00007	Missing or invalid -STARTMODE parameter. Valid -STARTMODE parameter is AUTO or MANUAL.
00008	A valid service name is OracleService appended with a SID
00009	SID name is mandatory.
00010	SYSTEM\CurrentControlSet\Services\OracleService key does not exist.
00011	The specified service does not exist.
00012	A PFILE is necessary for AUTOSTART option.
00013	Service start mode could not be set in the registry.
00014	Cannot open the Windows NT Service Control Manager.

Oradim Errors	DIM-0000 to DIM-0039
00015	Cannot start already-running ORACLE - shut it down first.
00016	Missing or invalid -SHUTTYPE parameter. A valid -SHUTTYPE parameter is SRVC or INST.
00017	Instance shutdown mode must be one of the following: a for abort, i for immediate or n for normal.
00018	Failed to stop Oracle Service.
00019	Create Service Error.
00020	A service for this name exists.
00021	Registry open failed.
00023	Create an instance by specifying the following options:
00024	-NEW -SID sid   -SRVC srvc   -ASMSID sid   -ASMSRVC srvc [-SYSPWD pass]
00025	[-STARTMODE auto   manual] [-SRVCSTART system   demand] [-PFILE file   -SPFILE]
00026	[-SHUTMODE normal   immediate   abort] [-TIMEOUT secs] [-RUNAS osusr/ospass]
00027	Edit an instance by specifying the following options:
00028	-EDIT -SID sid   -ASMSID sid [-SYSPWD pass]
00029	[-STARTMODE auto   manual] [SRVCSTART system   demand] [-PFILE file   -SPFILE]
00030	[-SHUTMODE normal   immediate   abort] [-SHUTTYPE srvc   inst] [-RUNAS osusr/ospass]
00031	Delete instances by specifying the following options:
00032	-DELETE -SID sid   -ASMSID sid   -SRVC srvc   -ASMSRVC srvc
00033	Startup services and instance by specifying the following options:
00034	-STARTUP -SID sid   -ASMSID sid [-SYSPWD pass]
00035	[-STARTTYPE srvc   inst   srvc,inst] [-PFILE filename   -SPFILE]
00036	Shutdown services and instance by specifying the following options:
00037	-SHUTDOWN -SID sid   -ASMSID sid [-SYSPWD pass]
00038	[-SHUTTYPE srvc   inst   srvc,inst] [-SHUTMODE normal   immediate   abort]
00039	Query for help by specifying the following parameters: -?   -h   -help
00040	Invalid option for the -NEW command.
00041	Invalid option for the -EDIT command.
00042	Invalid option for the -DELETE command.
00043	Invalid option for the -STARTUP command.
00044	Invalid option for the -SHUTDOWN command.
00045	Internal error in ORADIM.
00046	Invalid Pfile.



---

Oradim Errors	DIM-0000 to DIM-0039
00050	Instance deleted.
00051	Instance created.
00075	Failed to control service.
00076	Failed to delete service.
00077	Failed to change service configuration.
00078	Failed to start service.

---

**DIM-00000**

*ORADIM completed with no errors.*

**Cause:** The specified operation completed successfully.

**Action:** None.

**DIM-00001**

*ORADIM: <command> [options]. Refer to manual.*

**Cause:** The specified options were invalid or no arguments were supplied.

**Action:** Usage: ORADIM <command> [options]

**DIM-00002**

*The specified command was invalid.*

**Cause:** Valid commands are: -DELETE, -EDIT, -NEW, -STARTUP, and -SHUTDOWN.

**Action:** Use valid command.

**DIM-00003**

*An argument is missing for the parameter.*

**Cause:** Missing or invalid argument.

**Action:** Use a valid argument and invoke the program again.

**DIM-00004**

*SID or service name was not specified.*

**Cause:** Either a SID or service name is mandatory.

**Action:** Enter a valid *SID* of 64 characters and retry.

**DIM-00005**

*SID with more than 64 characters specified.*

**Cause:** SID with more than 64 characters specified.

**Action:** Change SID to 64 unique characters and make sure that there is no other service with this name.

**DIM-00006**

*Missing SID.*

**Cause:** SID was not specified in the arguments.

**Action:** Specify a SID.

**DIM-00007**

*Missing or invalid -STARTMODE parameter. Valid -STARTMODE parameter is AUTO or MANUAL.*

**Cause:** An argument for STARTMODE is missing.

**Action:** Enter a valid start mode and retry.

**DIM-00008**

*A valid service name is OracleService appended with a SID*

**Cause:** The Oracle service name specified is invalid.

**Action:** Correct the name of service and retry.

**DIM-00009**

*SID name is mandatory.*

**Cause:** SID was not specified.

**Action:** Enter the SID and retry.

**DIM-00010**

*SYSTEM\CurrentControlSet\Services\OracleService key does not exist.*

**Cause:** Specified registry key was not found.

**Action:** Try reinstalling. If the problem persists, contact Oracle Support Services.

**DIM-00011**

*The specified service does not exist.*

**Cause:** An attempt to edit a service failed.

**Action:** Make sure the service exists or user has enough privileges.

**DIM-00012**

*A PFILE is necessary for AUTOSTART option.*

**Cause:** A parameter file {PFILE} was not specified.

**Action:** Specify a parameter file.

**DIM-00013**

*Service start mode could not be set in the registry.*

**Cause:** The start mode entry in the registry for the service could not be set.

**Action:** Check if the user has privileges to modify registry.

**DIM-00014**

*Cannot open the Windows NT Service Control Manager.*

**Cause:** The Service Control Manager could not be opened.

**Action:** Check for user privileges.

**DIM-00015**

*Cannot start already-running ORACLE - shut it down first.*

**Cause:** The instance is already started.

**Action:** Stop the database before restarting.

**DIM-00016**

*Missing or invalid -SHUTTYPE parameter. A valid -SHUTTYPE parameter is SRVC or INST.*

**Cause:** An option for SHUTTYPE was missing or invalid.

**Action:** Enter parameter to shut down the instance or the service and retry.

**DIM-00017**

*Instance shutdown mode must be one of the following: a for abort, i for immediate or n for normal.*

**Cause:** Invalid option to shut down the instance was specified.

**Action:** Enter the correct mode and retry.

**DIM-00018**

*Failed to stop Oracle Service.*

**Cause:** An attempt to stop the service failed.

**Action:** Retry, check for user privileges.

**DIM-00019**

*Create service error.*

**Cause:** Service could not be created.

**Action:** Check for user privileges and retry.

**DIM-00020**

*A service for this name exists.*

**Cause:** An attempt was made to create a service name when it already existed.

**Action:** Retry with a different service name or SID.

**DIM-00021**

*Registry open failed*

**Cause:** An attempt to open the registry failed.

**Action:** Check for user privileges and retry the operation.

**DIM-00023**

*Create an instance by specifying the following options:*

**Cause:** n/a

**Action:** n/a

**DIM-00024**

*-NEW -SID sid | -SRVC srv | -ASMSID sid | -ASMSRVC srv [-SYSPWD pass]*

**Cause:** n/a

**Action:** n/a

**DIM-00025**

*[-STARTMODE auto | manual] [-SRVCSTART system | demand] [-PFILE file | -SPFILE]*

**Cause:** n/a

**Action:** n/a

**DIM-00026**

*[-SHUTMODE normal | immediate | abort] [-TIMEOUT secs] [-RUNAS osusr/ospass]*

**Cause:** n/a

**Action:** n/a

**DIM00027**

*Edit an instance by specifying the following options:*

**Cause:** n/a

**Action:** n/a

**DIM-00028**

*-EDIT -SID sid | -ASMSID sid [-SYSPWD pass]*

**Cause:** n/a

**Action:** n/a

**DIM-00029**

*[-STARTMODE auto | manual] [-SRVCSTART system | demand] [-PFILE file | -SPFILE]*

**Cause:** n/a

**Action:** n/a

**DIM-00030**

*[-SHUTMODE normal | immediate | abort] [-SHUTTYPE srvc | inst] [-RUNAS osusr/ospass]*

**Cause:** n/a

**Action:** n/a

**DIM-00031**

*Delete instances by specifying the following options:*

**Cause:** n/a

**Action:** n/a

**DIM-00032**

*-DELETE -SID sid | -ASMSID sid | -SRVC srvc | -ASMSRVC srvc*

**Cause:** n/a

**Action:** n/a

**DIM-00033**

*Start up services and instance by specifying the following options:*

**Cause:** n/a

**Action:** n/a

**DIM-00034**

*-STARTUP -SID sid | -ASMSID sid [-SYSPWD pass]*

**Cause:** n/a

**Action:** n/a

**DIM-00035**

*[-STARTTYPE srv | inst | srv,inst] [-PFILE filename | -SPFILE]*

**Cause:** n/a

**Action:** n/a

**DIM-00036**

*Shut down services and instance by specifying the following options:*

**Cause:** n/a

**Action:** n/a

**DIM-00037**

*-SHUTDOWN -SID sid | -ASMSID sid [-SYSPWD pass]*

**Cause:** n/a

**Action:** n/a

**DIM-00038**

*[-SHUTTYPE srv | inst | srv,inst] [-SHUTMODE normal | immediate | abort]*

**Cause:** n/a

**Action:** n/a

**DIM-00039**

*Query for help by specifying the following parameters: -? | -h | -help*

**Cause:** n/a

**Action:** n/a

**DIM-00040**

*Invalid option for the -NEW command.*

**Cause:** One or more arguments for creating new service is invalid.

**Action:** Specify required option and retry.

**DIM-00041**

*Invalid option for the -EDIT command.*

**Cause:** One or more arguments for editing existing service is invalid.

**Action:** Specify required option and retry.

**DIM-00042**

*Invalid option for the -DELETE command.*

**Cause:** One or more arguments for deleting service is invalid.

**Action:** Specify required option and retry.

**DIM-00043**

*Invalid option for the -STARTUP command.*

**Cause:** One or more arguments for starting the instance is invalid.

**Action:** Specify required option and retry.

**DIM-00044**

*Invalid option for the -SHUTDOWN command.*

**Cause:** One or more arguments for shutting down the instance is invalid.

**Action:** Specify required option and retry.

**DIM-00045**

*Internal error in ORADIM*

**Cause:** Unknown.

**Action:** Contact Oracle Support Services.

**DIM-00046**

*Invalid Pfile.*

**Cause:** The parameter filename is invalid.

**Action:** Check that the path name is correct.

**DIM-00050**

*Instance deleted*

**Cause:** The request for deleting instance was successful.

**Action:** None.

**DIM-00051**

*Instance created.*

**Cause:** The request for creating new instance was successful.

**Action:** None.

**DIM-00075**

*Failed to control service.*

**Cause:** An attempt to control the service failed.

**Action:** Check additional error, make sure that user has enough privileges.

**DIM-00076**

*Failed to delete service.*

**Cause:** The request for service deletion failed.

**Action:** Check additional error, make sure that user has enough privileges.

**DIM-00077**

*Failed to change service configuration.*

**Cause:** An attempt to change configuration failed.

**Action:** Check additional error, make sure that user has enough privileges.

**DIM-00078**

*Failed to start service.*

**Cause:** The request to start service failed.

**Action:** Check additional error, make sure that user has enough privileges.

## Database Connection Issues

The following are common Oracle Database connection error codes, their causes, and suggested remedies.

**TNS-12203**

*TNS: unable to connect to destination*

**Cause:** OracleServiceSID service, OracleHOME\_NAMETNSListener service, or both are not running.

**Action:** Ensure that both services are started.



**ORA-12560**

*TNS: lost contact*

**Cause:** OracleServiceSID service, OracleHOME\_NAMETNSListener service, or both are not running. You receive this error if you attempt to use any Oracle Database utilities, such as SQL\*Plus. This error is analogous to the following Oracle7 error: ORA-09352: Windows 32-bit Two-Task driver unable to spawn new ORACLE task.

**Action:** Ensure that both services are started.

**ORA-28575**

*unable to open RPC connection to external procedure agent*

**Cause:** tnsnames.ora and listener.ora files have not been correctly configured to use **external procedures**.

**Action:** Reconfigure services.

**ORA-06512**

*at "APPLICATIONS.OSEXEC", line 0*

**Cause:** tnsnames.ora and listener.ora files have not been correctly configured to use external procedures.

**Action:** Reconfigure services.

**ORA-06512**

*at "APPLICATIONS.TEST", line 4*

**Cause:** tnsnames.ora and listener.ora files have not been correctly configured to use external procedures.

**Action:** Reconfigure services.

**ORA-06512**

*at line 2*

**Cause:** tnsnames.ora and listener.ora files have not been correctly configured to use external procedures.

**Action:** Reconfigure services.

### ORA-01031 and LCC-00161

*Both codes appear at startup*

**Cause:** Parameter file (init.ora) or Windows services are damaged. These errors usually appear when the parameter file cannot be read by Oracle Database at database startup.

**Action:** Delete and re-create the SID and services. Make sure you are logged on as the user Administrator, or a user within the Windows Administrator's Group with full administrative rights. At the command prompt, enter: `oradim -delete -sid sid` where *sid* is the name of your database (for example, `orcl`). Re-create the SID and services by entering: `oradim -new -sid sid -startmode auto -pfile full_path_to_init.ora`

---

---

# Using Oracle Database on Windows 2000

This chapter highlights differences between Windows 2000 and Windows NT, with emphasis on procedures for common database tasks.

This chapter contains these topics:

- [How to Perform Common Tasks in Windows NT and Windows 2000](#)
- [Other Differences Between Windows NT and Windows 2000](#)

## How to Perform Common Tasks in Windows NT and Windows 2000

Table E-1 lists common database administration tasks and tools required to accomplish those tasks in Windows NT and Windows 2000.

**Table E-1** *How to Perform Common Tasks in Windows NT and Windows 2000*

<b>Task</b>	<b>Windows NT</b>	<b>Windows 2000</b>
Install a domain controller	Windows setup	Active Directory installation wizard from Configure Your Server
Manage user accounts	User Manager Choose <b>Start &gt; Programs &gt; Administrative Tools &gt; User Manager</b>	Active Directory Users & Computers Choose <b>Programs &gt; Administrative Tools &gt; Active Directory</b>
Manage groups	User Manager	Active Directory Users & Computers
Manage computer accounts	Server Manager Choose <b>Start &gt; Programs &gt; Administrative Tools &gt; Server Manager</b>	Active Directory Users & Computers
Add a computer to a domain	Server Manager	Active Directory Users & Computers
Create or manage trust relationships	User Manager	Active Directory Domains & Trusts
Manage account policy	User Manager	Active Directory Users & Computers
Manage user rights	User Manager	Active Directory Users & Computers: Edit the Group Policy object for the domain or organizational unit containing the computers to which the users rights apply.
Manage audit policy	User Manager	Active Directory Users & Computers: Edit the Group Policy object assigned to the Domain Controllers organizational unit.
Set policies on users and computers in a site	System Policy Editor Choose <b>Start &gt; Programs &gt; Administrative Tools &gt; System Policy Editor</b>	Group Policy, accessed through Active Directory Sites & Services
Set policies on users and computers in a domain	System Policy Editor	Group Policy, accessed through Active Directory Users & Computers

**Table E-1 (Cont.) How to Perform Common Tasks in Windows NT and Windows 2000**

<b>Task</b>	<b>Windows NT</b>	<b>Windows 2000</b>
Set policies on users and computers in an organizational unit	Not applicable	Group Policy, accessed through Active Directory Users & Computers
Use Security Groups to filter the scope of policy	Not applicable	Edit the permissions entry for Apply Group Policy on the security tab of the Group Policy Object properties sheet
Start Oracle Counters for Windows Performance Monitor	Choose <b>Start &gt; Programs &gt; Oracle - HOME_NAME &gt; Configuration and Migration Tools &gt; Oracle Counters for Windows Performance Monitor</b>	Choose <b>Start &gt; Programs &gt; Oracle - HOME_NAME &gt; Configuration and Migration Tools &gt; Oracle Counters for Windows Performance Monitor</b>
Access <b>services</b> dialog	Choose <b>Start &gt; Settings &gt; Control Panel &gt; Services</b>	Choose <b>Start &gt; Settings &gt; Control Panel &gt; Administrative Tools &gt; Services</b>

## Other Differences Between Windows NT and Windows 2000

This section discusses differences between Windows NT and Windows 2000 that are not related to common tasks.

### No DNS Domain Name for Windows 2000 Computer

If a Windows 2000 computer is not identified with a DNS domain name, then you will receive the following error message:

```
Calling query w32RegQueries1.7.0.17.0 RegGetValue
Key = HKEY_LOCAL_MACHINE
SubKey = SYSTEM\CurrentControlSet\Services\Tcpip\Parameters
Value = Domain
```

```
Query Exception: GetValueKeyNotFoundException
Query Exception Class: class oracle.sysman.oii.oii.OiiQueryException
...
```

Perform the following steps:

1. Choose **Start > Control Panel > System > Network Identification > Property > More > Primary DNS**.
2. Enter a domain name, for example, `us.oracle.com`.

## Microsoft Management Console Included in Windows 2000

**Microsoft Management Console**, available in Windows NT as a separate item from Microsoft, is included in Windows 2000.

## Raw Partitions

In Windows NT, use Disk Administrator to create **raw partitions** required for Oracle Real Application Clusters.

In Windows 2000, use Computer Management to create basic disks (compatible with raw partitions on Windows NT). Choose **Start > Programs > Administrative Tools > Computer Management**.

## Services Autostart

**Oracle services** autostart on Windows NT 4.0. After upgrading to Windows 2000, you may find that services start but the database does not start.

The solution is to use ORADIM to delete and re-create the services.

To delete an **instance** using ORADIM, enter:

```
ORADIM -DELETE -SID SIDA, SIDB, SIDC, ...  
ORADIM -DELETE -SRVC SRVCA, SRVCB, SRVC, ...
```

where:

- *SIDA, SIDB, SIDC* are values of the SIDs to delete.
- *SRVCA, SRVCB, SRVC* are values of the services to delete.

During upgrading, the disk is converted to NTFS 5, and a different access **authorization** is used. The new services autostart under the same account, but they no longer hold the same Windows permissions as before.

---

---

# Oracle Database Windows/UNIX Differences

This chapter lists major differences between Oracle Database on Windows and UNIX. For Oracle Database developers and database administrators moving from a UNIX platform to Windows, this information can be helpful in understanding Windows features that are relevant to Oracle Database.

This chapter contains these topics:

- [Automatic Startup and Shutdown](#)
- [Background Processing and Batch Jobs](#)
- [Diagnostic and Tuning Utilities](#)
- [Direct Writes to Disk](#)
- [Dynamic Link Libraries \(DLLs\)](#)
- [Hot Backups](#)
- [Initialization Parameters: Multiple Database Writers](#)
- [Install Accounts and Groups](#)
- [Installation](#)
- [Memory Resources](#)
- [Microsoft Transaction Server](#)
- [Multiple Oracle Homes and OFA](#)
- [Processes and Threads](#)
- [Raw Partitions](#)
- [Services](#)

## Automatic Startup and Shutdown

On UNIX, several files and scripts in different directories are used to start an **instance** automatically. Other scripts are run on computer shutdown, allowing applications such as Oracle Database to shut down cleanly.

For automatic startup on Windows, set **registry** parameter `ORA_SID_AUTOSTART` to `true` using an Oracle Database tool such as ORADIM. Enter the following with parameters at the command prompt:

```
C:\> oradim options
```

To start the **listener** automatically, set **services** startup type to automatic.

For automatic shutdown on Windows, set registry parameters `ORA_SHUTDOWN` and `ORA_SID_SHUTDOWN` to stop the relevant OracleServiceSID and shut down. Set registry parameter `ORA_SID_SHUTDOWNTYPE` to control shutdown mode (default is `i`, or `immediate`).

### See Also:

- [Chapter 6, "Administering a Database on Windows"](#)
- *Oracle 2 Day DBA*

## Background Processing and Batch Jobs

UNIX provides sophisticated control mechanisms for background processing and batch jobs.

For similar functionality on Windows, use the AT command or a GUI version in the Microsoft Resource Kit.

## Diagnostic and Tuning Utilities

On UNIX, utilities such as `sar` and `vmstat` are used to monitor Oracle Database background and shadow processes. These utilities are not integrated with Oracle Database.

Performance utilities available on Windows include Oracle Counters for Windows Performance Monitor, Task Manager, Control Panel, Event Viewer, User Manager, and **Microsoft Management Console** (included only with Windows 2000).



Oracle Database is integrated with several of these tools. For example:

- Oracle Counters for Windows Performance Monitor displays key Oracle Database information. This tool is the same in appearance and operation as Windows Performance Monitor, except it has been preloaded with Oracle Database performance elements.
- Event Viewer displays system alert messages, including Oracle Database startup/shutdown messages and audit trail.
- Task Manager on Windows displays currently running processes and their resource usage, similar to the UNIX `ps -ef` command or HP OpenVMS `SHOW SYSTEM`. But Task Manager is easier to interpret and the columns can be customized.

**See Also:**

- [Chapter 3, "Database Tools on Windows"](#)
- [Chapter 7, "Monitoring a Database on Windows"](#)

## Direct Writes to Disk

On both UNIX and Windows platforms, bypassing the file system buffer cache ensures data is written to disk.

On UNIX, Oracle Database uses the `O_SYNC` flag to bypass the file system buffer cache. The flag name depends on the UNIX port.

On Windows, Oracle Database bypasses the file system buffer cache completely.

## Dynamic Link Libraries (DLLs)

Shared libraries on UNIX are similar to shared DLLs on Windows. Object files and archive libraries are linked to generate Oracle Database executables. Relinking is necessary after certain operations, such as installation of a patch.

On Windows, Oracle Database DLLs form part of the executable at run time and are therefore smaller. DLLs can be shared between multiple executables. Relinking by the user is not supported, but executable images can be modified using `ORASTACK`.

Modifying executable images on Windows reduces the chances of running out of virtual memory when using a large SGA or when supporting thousands of connections. However, Oracle recommends doing this only under the guidance of Oracle Support Services.

## Hot Backups

A (manual) hot **backup** is equivalent to backing up a **tablespace** that is in offline backup mode.

Backup strategy on UNIX is as follows: put the tablespace into backup mode, copy the files to the backup location, and bring the tablespace out of backup mode.

Windows supports the same backup strategy, but you cannot copy files in use with normal Windows utilities. Use OCOPY to copy open database files to another disk location. Then use a utility to copy the files to tape.

## Initialization Parameters: Multiple Database Writers

On UNIX, you can specify more than one database writer **process** with initialization parameter `DB_WRITERS`. Multiple database writers can help, for example, when a UNIX port does not support asynchronous I/O.

`DB_WRITERS` is supported but typically unnecessary on Windows, which has its own asynchronous I/O capabilities.

**See Also:** [Chapter 13, "Oracle Database Specifications for Windows"](#)

## Install Accounts and Groups

UNIX uses the concept of a DBA group. The root account cannot be used to install Oracle Database. A separate Oracle Database account must be created manually.

On Windows, Oracle Database must be installed by a Windows **username** in the Administrators group. The username is automatically added to the Windows local group `ORA_DBA`, which receives the **SYSDBA privilege**. This allows the user to log in to the database using `CONNECT / AS SYSDBA` and not be prompted for a password.

Password files are located in the `ORACLE_BASE\ORACLE_HOME\database` directory and are named `pwdSID.ora`, where `SID` identifies the Oracle Database instance.

**See Also:** [Chapter 6, "Administering a Database on Windows"](#)

## Installation

The following manual setup tasks, all required on UNIX, are *not* required on Windows:

- Set environment variables
- Create a DBA group for database administrators
- Create a group for users running Oracle Universal Installer
- Create an account dedicated to installing and upgrading Oracle Database components

**See Also:** *Oracle Database Installation Guide for Windows*

## Memory Resources

The resources provided by the UNIX default kernels are often inadequate for a medium or large instance of Oracle Database. The maximum size of a shared memory segment (SHMMAX) and maximum number of semaphores available (SEMMNS) may be too low for Oracle Database recommendations.

On Windows, fewer resources are needed for interprocess communication (IPC), because the Oracle Database relational database management system is **thread**-based and not process-based. These resources, including shared memory and semaphores, are not adjustable by the user.

## Microsoft Transaction Server

UNIX does not support **Microsoft Transaction Server**.

Windows supports Microsoft Transaction Server beginning with Oracle8. Using Oracle Services for Microsoft Transaction Server, you can develop and deploy applications based on **COM/COM+**. Microsoft Transaction Server coordinates application transactions for Oracle Database.

**See Also:** *Oracle Services for Microsoft Transaction Server Developer's Guide*

## Multiple Oracle Homes and OFA

The goal of OFA is to place all Oracle Database software under one **ORACLE\_HOME** directory and to spread database files across different physical drives as databases increase in size. OFA is implemented on Windows and UNIX in the same way, and main subdirectory and filenames are the same on both operating systems. Windows and UNIX differ, however, in their OFA directory tree top-level names and in the way variables are set.

On UNIX, *ORACLE\_BASE* is associated with a user's environment. *ORACLE\_HOME* and *ORACLE\_SID* must be set in system or user login scripts. Symbolic links are supported. Although everything seems to be in one directory on the same hard drive, files may be on different hard drives if they are symbolically linked or have that directory as a **mount** point.

On Windows, *ORACLE\_BASE* is defined in the registry (for example, in `HKEY_LOCAL_MACHINE\SOFTWARE\ORACLE\HOME0`). *ORACLE\_HOME* and *ORACLE\_SID* are variables defined in the registry. Symbolic links like those on UNIX are not supported, although Microsoft has announced the intention to support them in a future release.

**See Also:** [Chapter 2, "Multiple Oracle Homes and Optimal Flexible Architecture"](#)

## Processes and Threads

On UNIX, Oracle Database uses a process to implement each of such background tasks as database writer (DBW0), log writer (LGWR), shared server process dispatchers, and shared servers. Each dedicated connection made to the database causes another operating system process to be spawned on behalf of that session.

On Windows, each background process is implemented as a thread inside a single, large process. For each Oracle Database instance or **system identifier**, there is one corresponding process for Oracle Database. For example, 100 Oracle Database processes for a database instance on UNIX are handled by 100 threads inside one process on Windows.

All Oracle Database background, dedicated server, and client processes are threads of the master Oracle Database Windows process, and all threads of the Oracle Database process share resources. This multithreaded architecture is highly efficient, allowing fast context switches with low overhead.

To view processes or end individual threads, use Oracle Administration Assistant for Windows. Choose Start > Programs > Oracle - *HOME\_NAME* > Configuration and Migration Tools > Administration Assistant for Windows. Right-click the *SID* and choose Process Information.

---

---

**Note:** Microsoft Management Console (MMC) is started when Oracle Administration Assistant for Windows is started. Oracle Database has integrated several database administration **snap-ins** into MMC.

---

---

**See Also:**

- Oracle Administration Assistant for Windows online help
- [Chapter 1, "Oracle Database Architecture on Windows"](#)

## Raw Partitions

Datafiles for tablespaces may be stored on a file system or on **raw partitions**. A raw partition is a portion of a physical disk that is accessed at the lowest possible level.

UNIX supports raw partitions (logical drives). There is no limitation on the number of disk drives.

Windows is limited to using drive letters A-Z, but creating raw partitions lets you bypass the disk drive limitation and divide disks into smaller sections.

Use Windows disk management tools to create an extended partition on a physical drive. An extended partition points to raw space on the disk that can be assigned multiple logical partitions for database files.

An extended partition avoids the four-partition limit on Windows by allowing you to define large numbers of logical partitions to accommodate applications using Oracle Database. Logical partitions can then be given symbolic link names to free up drive letters.

---

---

**Note:** Raw partitions are necessary for shared datafiles in an Oracle Real Application Clusters environment, available on Windows. Oracle Real Application Clusters, in which Oracle Database instances run on all nodes simultaneously, provides clustering and high availability. Oracle Real Application Clusters is not supported on Windows XP.

---

---

**See Also:** [Appendix E, "Using Oracle Database on Windows 2000"](#)

## Services

Windows services are similar to UNIX daemons.

Oracle Database registers a database instance as a service (OracleServiceSID). Services start background processes.

To connect to and use an Oracle Database instance, an Oracle Database service is created during database creation and associated with Oracle Database. Once a service is created with Oracle Database, the service can run even while no user is logged on.

By default, services run under the **SYSTEM** account. Choose **Start > Settings > Control Panel > Services** to access the Services dialog.

**See Also:** [Chapter 6, "Administering a Database on Windows"](#)

---

---

# Glossary

## **alert file**

A file that contains important information and error messages that are generated during database operations.

## **authenticate**

To verify the identity of a user, device, or other entity in a computer system, often as a prerequisite for allowing access to resources in a system.

## **authentication**

Identification of a user, device, or other entity in a computer system, often as a prerequisite for allowing access to resources in a system.

## **authorization**

Permission given to a user, program, or **process** to access an object or set of objects. In Oracle Database, authorization is done through the **role** mechanism. A single person or a group of people can be granted a role or a group of roles. A role, in turn, can be granted other roles.

## **backup**

A representative copy of data. This copy includes important parts of your database such as **control files**, **redo log files**, and datafiles.

A backup is a safeguard against unexpected data loss; if you lose your original data, then you can use the backup to make the data available again. A backup is also a safeguard against an application error; if an application makes incorrect changes, then you can restore the backup.

### **certificate authority**

A certificate authority (CA) is a trusted third party that certifies the identity of other entities such as users, databases, administrators, clients, and servers. The certificate authority verifies the user's identity and grants a certificate, signing it with one of the certificate authority's **private keys**.

### **COM/COM+**

Microsoft's Component Object Model is an object-oriented programming architecture and a set of operating system services. These services notify running application components of significant events and ensure that they are authorized to run. COM/COM+ is intended to make it relatively easy to create business applications that work well with **Microsoft Transaction Server** in Windows NT and Windows 2000.

### **connect descriptor**

A specially formatted description of the destination for a network connection. A connect descriptor contains destination **services** and network route information. The destination service is indicated by using its service name for Oracle9i or Oracle8i databases or its Oracle **system identifier** for Oracle8 release 8.0 databases. The network route provides, at a minimum, the location of the **listener** through use of a network address.

### **connect identifier**

A **net service name** or service name, that maps to a **connect descriptor**. Users initiate a connect request by passing a **username** and password along with a connect identifier in a **connect string** for the **services** to which they wish to connect, for example:

```
CONNECT username/password@connect_identifier
```

### **connect string**

See **net service name**.

### **control files**

Files that record the physical structure of a database and contain the database name, the names and locations of associated databases and online **redo log files**, the time stamp of the database creation, the current log sequence number, and checkpoint information.



**credentials**

A **username**, password, or certificate used to gain access to the database.

**data dictionary**

A set of read-only tables that provide information about a database.

**database alias**

See **net service name**.

**decryption**

Process of converting contents of a message that has gone through **encryption** (ciphertext) back into its original readable format (plaintext).

**digital certificates**

ITU X.509 v3 standard data structures that securely bind an identity to a **public key**. A certificate is created when an entity's public key is signed by a trusted identity, a **certificate authority**. The certificate ensures that the entity's information is correct and that the public key actually belongs to that entity.

**digital signature**

Digital signatures are created when a **public key** algorithm is used to sign messages with senders' **private keys**. A digital signature assures that a document is authentic, has not been forged by another entity, has not been altered, and cannot be repudiated by the sender.

**DLL**

See **dynamic link library**.

**downgrade**

To convert the data in Oracle Database to an earlier Oracle release. See **upgrade** and **migrate**.

**dynamic link library**

An executable file that a Windows application can load when needed.

**encryption**

Process of disguising a message, rendering it unreadable to any but the intended recipient.

**enterprise domains**

Directory constructs consisting of Oracle Database and enterprise users and roles. Enterprise domains are different from Windows 2000 domains, which are collections of computers that share a common directory database.

**enterprise role**

A directory structure which contains global roles on multiple databases, and which can be granted to an **enterprise user**.

**enterprise user**

A user that has a unique identity across an enterprise. An enterprise user connects to individual databases through a **schema** and is assigned an **enterprise role** that determines the user's access privileges on databases.

**external procedures**

Functions written in a third-generation language (C, for example) and callable from within **PL/SQL** or SQL as if they were PL/SQL functions or procedures.

**external role**

Roles created and managed by Windows NT and Windows 2000 operating systems. Once an external role is created, you can grant or revoke that **role** to a database user. You must set **init.ora** parameter `OS_ROLES` to `true` and restart Oracle Database before you can create an external role. You cannot use both Windows operating systems and Oracle Database to grant roles concurrently.

**external routine**

A function written in a third-generation language (3GL), such as C, and callable from within **PL/SQL** or SQL as if it were a PL/SQL function or procedure.

**external user**

A user authenticated by the Windows 2000 or Windows NT operating system who can access Oracle Database without being prompted for a password. External users are typically regular database users (non-database administrators) to which you assign standard database roles (such as `CONNECT` and `RESOURCE`), but do not want to assign **SYSDBA** (database administrator) or **SYSOPER** (database operator) **privilege**.

**external user**

The Windows operating system can **authenticate** a user, who can then access Oracle Database without being prompted for a password. External users are typically

regular database users (non-database administrators) to whom you assign standard database roles (such as `CONNECT` and `RESOURCE`), but do not want to assign the **`SYSDBA`** (database administrator) or **`SYSOPER`** (database operator) **privilege**.

### **global groups**

See **[Windows global groups](#)**.

### **global role**

A role whose privileges are contained within a single database, but which is managed in a directory.

### **Globalization Support**

The Oracle Database architecture that ensures that database utilities, error messages, sort order, date, time, monetary, numeric, and calendar conventions automatically adapt to the native language and locale.

### ***HOME\_NAME***

Represents the name of an Oracle home. In Oracle Database 10g, all Oracle homes have a unique *HOME\_NAME*.

### **init.ora**

See **[initialization parameter file](#)**.

### **initialization parameter file**

An ASCII text file that contains information needed to initialize a database and **[instance](#)**.

### **instance**

Every running Oracle Database is associated with an Oracle Database instance. When a database is started on a database server (regardless of the type of computer), Oracle Database allocates a memory area called the **[System Global Area](#)** and starts one or more Oracle Database processes. This combination of the System Global Area and Oracle Database processes is called an instance. The memory and processes of an instance manage the associated database's data efficiently and serve the users of the database.

### **instantiate**

Produce a more defined version of some object by replacing variables with values (or other variables).

**latch**

A simple, low-level serialization mechanism to protect shared data structures in the System Global Area.

**LDAP**

See [Lightweight Directory Access Protocol \(LDAP\)](#).

**Lightweight Directory Access Protocol (LDAP)**

A standard, extensible directory access protocol. It is a common language that LDAP clients and servers use to communicate. LDAP is a framework of design conventions supporting industry-standard directory products, such as Oracle Internet Directory.

**listener**

The Oracle Database server [process](#) that listens for and accepts incoming connection requests from client applications. The listener process starts up Oracle Database processes to handle subsequent communications with the client; then it goes back to listening for new connection requests.

**listener.ora**

A configuration file that describes one or more Transparent Network Substrate (TNS) listeners on a server.

**local groups**

See [Windows local groups](#).

**local roles**

Roles created and managed by the database. Once a local role is created, you can grant or revoke that [role](#) to a database user. You cannot use Windows NT (for [external role](#) management) and Oracle Database (for local role management) concurrently.

**Microsoft Management Console**

An application that serves as a host for administrative tools called [snap-ins](#). By itself, Microsoft Management Console does not provide any functionality.

**Microsoft Transaction Server**

A transaction processing system based on [COM/COM+](#) that runs on an Internet or network server.

**migrate**

To [upgrade](#) or [downgrade](#) an Oracle Database or convert the data in a non-Oracle database into an Oracle Database.

**mount**

To associate a database with an [instance](#) that has been started.

**MTS**

See [Microsoft Transaction Server](#)

**multiple Oracle homes**

The capability of having more than one Oracle home on a computer.

**net service name**

The name used by clients to identify an Oracle Net server and the specific [system identifier](#) or database for the [Oracle Net](#) connection. A net service name is mapped to a port number and protocol. Also known as a connect string, database alias, host string, or service name.

This also identifies the specific SID or database to which the connection is attaching, not just the Oracle Net server.

**network listener**

A listener on a server that listens for connection requests for one or more databases on one or more protocols. See [listener](#).

**network service**

In an Oracle application network, a service performs tasks for its service consumers. For example, a Names Server provides name resolution services for clients.

**obfuscated**

Protected by a process often used by companies for intellectual property written in the form of Java programs. The obfuscation process mixes up Java symbols found in the code. It leaves the original program structure intact, allowing the program to run correctly, while changing the names of the classes, methods, and variables in order to hide the intended behavior. Although it is possible to decompile and read non-obfuscated Java code, obfuscated Java code is sufficiently difficult to decompile to satisfy U.S. government export controls.

## **OCI**

See [Oracle Call Interface](#).

## **OFA**

See [Optimal Flexible Architecture](#).

## **Optimal Flexible Architecture**

A set of file naming and placement guidelines for Oracle Database software and databases.

## **Oracle Call Interface**

An application programming interface that enables you to manipulate data and [schema](#) in an Oracle Database. You compile and link an Oracle Call Interface application in the same way that you compile and link a non-database application. There is no need for a separate preprocessing or precompilation step.

## **ORACLE\_HOME**

Corresponds to the environment in which Oracle Database products run. This environment includes location of installed product files, `PATH` variable pointing to products' binary files, [registry](#) entries, [net service name](#), and program groups.

If you install an OFA-compliant database, using Oracle Universal Installer defaults, Oracle home (known as `\ORACLE_HOME` in this guide) is located beneath `X:\ORACLE_BASE`. It contains subdirectories for Oracle Database software executables and network files.

## **Oracle Internet Directory**

An Oracle Database-based LDAP V3 directory server, used for centralizing database user, [Oracle Net](#) network connector, and database [listener](#) parameters.

## **Oracle Net**

A component of [Oracle Net Services](#) that enables a network session from a client application to an Oracle Database server. Once a network session is established, Oracle Net acts as a data courier for the client application and the database server. It is responsible for establishing and maintaining the connection between the client application and database server, as well as exchanging messages between them. Oracle Net is able to perform these jobs because it is located on each computer in the network.

## **Oracle Net Services**

A suite of networking components that provide enterprise-wide connectivity solutions in distributed, heterogeneous computing environments. Oracle Net Services are comprised of **Oracle Net, listener**, Oracle Connection Manager, Oracle Net Configuration Assistant, and Oracle Net Manager.

## **Oracle PKI**

Oracle Advanced Security includes Oracle PKI (public key infrastructure) integration for authentication and single sign-on. Oracle-based applications are integrated with the PKI authentication and encryption framework, using Oracle Wallet Manager.

## **Oracle Protocol Support**

A product that maps the functions of a given network protocol into Oracle Transparent Network Substrate (TNS) architecture. This process translates TNS function calls into requests to the underlying network protocol. This allows TNS to act as an interface among all protocols. **Oracle Net** requires Oracle Protocol Support.

## **Oracle services**

Windows **services** that are associated with particular Oracle Database components.

## ***ORACLE\_BASE***

*ORACLE\_BASE* is the root of the Oracle Database directory tree. If you install an OFA-compliant database using Oracle Universal Installer defaults, then *ORACLE\_BASE* is X:\oracle where X is any hard drive (for example, C:\oracle).

## ***ORACLE\_HOME***

Corresponds to the environment in which Oracle Database products run. This environment includes the location of installed product files, the PATH variable pointing to the binary files of installed products, **registry** entries, **net service names**, and program groups.

If you install an OFA-compliant database, using Oracle Universal Installer defaults, then Oracle home (known as *\ORACLE\_HOME* in this guide) is located beneath X:\ORACLE\_BASE. It contains subdirectories for Oracle Database software executables and network files.

## **PL/SQL**

Procedural language extension to SQL that is part of Oracle Database.

PL/SQL enables you to mix SQL statements with procedural constructs. You can define and run PL/SQL program units such as procedures, functions, and packages.

### **precompiler**

A programming tool that enables you to embed SQL statements in a high-level source program.

### **private keys**

In **public key cryptography**, these are the secret keys. They are used primarily for **decryption** but also for **encryption** with a **digital signature**.

### **privilege**

A right to run a particular type of SQL statement or to access another user's object.

### **process**

A mechanism in an operating system that can run an executable. (Some operating systems use the terms job or task.) A process normally has its own private memory area in which it runs. On Windows a process is created when an application runs (such as Oracle Database or Microsoft Word). In addition to an executable program, all processes consist of at least one **thread**. The Oracle Database master process contains hundreds of threads.

### **public key**

In **public key cryptography**, this key is made public to all. It is primarily used for **encryption** but can also be used for verifying signatures.

### **public key cryptography**

Public key cryptography involves information **encryption** and **decryption** using a shared **public key** paired with **private keys**. Provides for secure, private communications within a public network.

### **quota**

A limit on a resource, such as a limit on the amount of database storage used by a database user. A database administrator can set **tablespace** quotas for each Oracle Database **username**.

### **raw partitions**

Portions of a physical disk that are accessed at the lowest possible disk (block) level.



**recovery**

To restore a physical **backup** is to reconstruct it and make it available to the Oracle Database server. To recover a restored backup is to update it using redo records (that is, records of changes made to the database after the backup was taken). Recovering a backup involves two distinct operations: rolling forward the backup to a more current time by applying redo data, and rolling back all changes made in uncommitted transactions to their original state.

**redo log buffer**

A circular buffer in the **System Global Area** that contains information about changes made to the database.

**redo log files**

Files that contain a record of all changes made to data in the database buffer cache. If an instance failure occurs, then the redo log files are used to recover the modified data that was in memory.

**registry**

A Windows repository that stores configuration information for a computer.

**remote computer**

A computer on a network other than the local computer.

**remote database**

A database on a computer other than the local database.

**replication**

The process of copying and maintaining database objects in multiple databases that make up a distributed database system.

**role**

A named groups of related privileges. You can grant a role to users or to another role.

**schema**

A named collection of objects, such as tables, views, clusters, procedures, and packages, associated with one or more particular users.

**services**

Executable processes installed in the Windows [registry](#) and administered by Windows. Once services are created and started, they can run even when no user is logged on to the computer.

**service name**

See [net service name](#).

**SGA**

See [System Global Area](#).

**Shared Server Process**

A server configuration which allows many user processes to share very few server processes. The user processes connect to a dispatcher background process, which routes client requests to the next available shared server process.

**SID**

See [system identifier](#).

**snap-ins**

Administrative tools that run within [Microsoft Management Console](#).

**snapshot**

(1) Information stored in rollback segments to provide transaction [recovery](#) and read consistency. Rollback segment information can be used to re-create a snapshot of a row before an update.

(2) A point-in-time copy of a master table located on a remote site. Read-only snapshots can be queried, but not updated. Updateable snapshots can be queried and updated. They are periodically refreshed to reflect changes made to the master table, and at the snapshot site.

**starter database**

A preconfigured, ready-to-use database that requires minimal user input to create.

**SYSDBA**

A special database administration role that contains all system privileges with the ADMIN OPTION, and the [SYSOPER](#) system privilege. SYSDBA also permits CREATE DATABASE actions and time-based recovery.

## **SYSOPER**

A special database administration role that permits a database administrator to perform `STARTUP`, `SHUTDOWN`, `ALTER DATABASE OPEN/MOUNT`, `ALTER DATABASE BACKUP`, `ARCHIVE LOG`, and `RECOVER`, and includes the `RESTRICTED SESSION` privilege.

## **System Global Area**

A group of shared memory structures that contain data and control information for an Oracle Database **instance**.

## **system identifier**

A unique name for an Oracle Database **instance**. To switch between instances of Oracle Database, users must specify the desired system identifier. The system identifier is included in the `CONNECT DATA` parts of the connect descriptors in a `tnsnames.ora` file, and in the definition of the **network listener** in a `tnsnames.ora` file.

## **SYSTEM**

One of two standard database administrator usernames automatically created with each database. (The other username is `SYS`.) The `SYSTEM` username is the preferred username for database administrators to use for database maintenance.

## **tablespace**

A database is divided into one or more logical storage units called tablespaces. Tablespaces are divided into logical units of storage called segments, which are further divided into extents.

## **thread**

An individual path of execution within a **process**. Threads are objects within a process that run program instructions. Threads allow concurrent operations within a process so that a process can run different parts of its program simultaneously on different processors. A thread is the most fundamental component that can be scheduled on Windows.

## **tnsnames.ora**

A file that contains connect descriptors mapped to net service names. The file can be maintained centrally or locally, for use by all or individual clients.

**trace file**

Each server and background **process** can write to an associated trace file. When a process detects an internal error, it dumps information about the error to its trace file. Some of the information written to a trace file is intended for the database administrator, while other information is intended for Oracle Support Services. Trace file information is also used to tune applications and instances.

**trust points**

Trust points or trusted certificates are third party identities that are qualified with a level of trust. A trusted certificate is used when an identity is being validated as the entity it claims to be. Certificate authorities you trust are called trusted certificates. If there are several levels of trusted certificates, a trusted certificate at a lower level in the certificate chain does not need to have all its higher level certificates reverified.

**universal groups**

Universal groups are available in Windows 2000, but not in Windows NT. They can contain other groups, including other universal groups, **local groups**, and **global groups**.

**upgrade**

To convert the data in an Oracle Database into a later release. See **downgrade** and **migrate**.

**username**

A name that can connect to and access objects in a database.

**view**

A selective presentation of the structure and data of one or more tables. Views can also be based on other views.

**Windows global groups**

Groups that can be granted permissions and rights in their own domain, member servers and workstations of their domain, and in trusted domains. They can also become members of **Windows local groups** in all these places. But global groups can contain user accounts only from their own domains.

**Windows local groups**

Groups that can be granted permissions and rights only for its own computer or, if part of a domain, to the domain controllers of that domain. Local groups can,

however, contain user accounts and **Windows global groups** from both their own domain and from trusted domains.

### **WOW64**

Abbreviation for Windows 32-On-Windows 64. WOW64 is an x86 emulator that runs on top of 64-bit Windows and allows 32-bit applications to execute.



---

---

# Index

## A

---

admin directory, explained, 2-12

Advanced Replication support

- data dictionary tables, 5-16
- initialization parameter requirements, 5-15
- tablespace requirements, 5-14, 5-16

alert files

- monitoring a database, 7-2
- using, 7-12

ALTER DATABASE ARCHIVELOG

- command, 6-19

application development

- and data access, 15-4
- finding information, 15-2

architecture

- thread-based, 1-2

ARCHIVELOG mode, 6-19

archiving mode

- controlling, 6-19
- custom database, 6-19
- starter database, 6-19

archiving procedures, 6-20

- for redo log files, 6-19
- specifying an archive destination, 6-20
- UNC not allowed, 6-18

audit trail

- managing, 7-12
- operating system, 3-15

AUDIT\_FILE\_DEST

- parameter, 7-12, 13-5

authentication

- automatically enabling during installation, 9-5
- enhancements, 9-3

OSAUTH\_PREFIX\_DOMAIN parameter, 10-40

overview, 9-2

- using a password file, 6-14
- using Windows native methods, 9-2
- viewing parameter settings, 10-14
- when to use enterprise users, 9-4
- when to use external users, 9-4

authentication protocols

- default protocol used, 9-3
- with Windows 2000, 9-2
- with Windows NT 4.0, 9-2

authorization

- when to use enterprise roles, 9-4
- when to use external roles, 9-4

auto-starting

- Oracle Database services, 6-5

## B

---

background processes

- querying, 1-4

BACKGROUND\_DUMP\_DEST, 7-12

backup

- control files, 14-7
- databases, 4-16

Backup Wizard

- preferred tools, 3-3

bad file

- specifying, 3-14

block size

- maximum, 13-7

blocks for each file, maximum, 13-7

## C

---

### commands

- ALTER DATABASE ARCHIVELOG, 6-19
- ARCHIVE LOG LIST, 6-19
- CREATE DATABASE, 4-11
- NET START, 4-12
- REGEDT32, 4-14

### configuration parameters

- defined, 14-2
- LOCAL, C-3
- registry, defined, 14-2
- TNS\_ADMIN, C-3
- USE\_SHARED\_SOCKET, C-4

### configuring

- Named Pipes Protocol Adapter, C-4
- Oracle Spatial, 5-13
- Oracle Text, 5-10

### CONNECT /AS SYSDBA

- connecting without a password, 9-5
- using, 6-8

### CONNECT INTERNAL

- replacement, 3-2

### connecting

- LOCAL parameter, C-3
- to a database, 6-8

### control files

- additional backslashes in r. 8.0.4, 4-3
- maximum size, 13-7

### CREATE DATABASE command, 4-11

### CREATE LIBRARY

- command, 15-11

### custom database

- archiving mode, 6-19

## D

---

### data dictionary

- Advanced Replication tables, 5-16

### Data Pump Export

- starting, 3-9

### Data Pump Import

- starting, 3-9

### database administrator privileges

- for a single database on a computer, 10-34

- for all databases on a computer, 10-5

### Database Configuration Assistant

- preferred tools, 3-3
- starting, 3-7

### database connection

- error messages, D-26

### database files

- deleting, 4-8

### database monitoring

- using Oracle Counters for Windows Performance Monitor, 7-2
- with alert files, 7-12
- with Event Viewer, 7-8
- with trace files, 7-12

### database operator privileges

- for a single database on a computer, 10-36
- for all databases on a computer, 10-7

### database privileges

- in Windows local groups, 10-48

### database tools

- operating system compatibility, 3-2
- starting from the command line, 3-8
- starting from the Start Menu, 3-6
- starting in multiple Oracle Homes, 3-6

### databases

- backing up, 4-16
- connecting to, 6-8
- creating manually, 4-4
- deleting, 4-8
- exporting, 4-6
- importing, 4-13
- monitoring, 7-2
- naming conventions, 4-2
- password encryption, 6-18
- shutting down, 6-8, 6-9
- starting, 6-8

### DB\_NAME

- directory, explained, 2-13

### DBVERIFY

- starting, 3-9

### debugging external procedures, 15-14

### developing applications

- for Windows, 15-2

### diagnostic and tuning utilities

- for Windows, 3-18



- disk striping, 2-18
- DisplayName parameter, C-2
- DLLs
  - compared to UNIX shared libraries, F-3
  - displaying with Task List, 3-19
  - external procedures, 15-11
  - Oracle Counters for Windows Performance Monitor, 14-9
  - Oracle Real Application Clusters, 14-10

## E

---

- encrypting, database passwords, 6-18
- enhanced security, 5-2 to 5-6
- enterprise roles
  - environments in which to use, 9-4
- enterprise users
  - environments in which to use, 9-4
- environment variables
  - ORACLE\_HOME, 2-6
  - TNS\_ADMIN, 2-7
- error messages
  - DIM-00000 to DIM-00039, D-17
  - Intercartridge Exchange, 15-21
  - ORA-00256, 4-3, 6-18
  - ORA-01102, 4-2
  - ORA-09275, D-2
  - ORA-09291, 4-3, 6-18
  - ORA-12560, D-27
  - OSD-04000 to OSD-04099, D-5
  - OSD-04018, 4-3, 6-18
  - OSD-04100 to OSD-04199, D-10
  - OSD-04200 to OSD-04299, D-11
  - OSD-04300 to OSD-04399, D-14
  - OSD-04400 to OSD-04499, D-15
  - OSD-04500 to OSD-04599, D-15
- Event Viewer, 7-2
  - blue (informational) icon, 7-8
  - defined, 3-15
  - for monitoring a database, 7-2
  - integration with Oracle Database, 3-15
  - logging operating system audit trail, 3-15
  - managing, 7-12
  - reading, 7-10
  - red (stop sign) icon, 7-8

- starting, 3-11
- using, 7-8
- yellow (exclamation point) icon, 7-8
- exception conditions, Intercartridge Exchange, 15-20
- executable images
  - modifying, 1-4
- EXECUTE privileges, on a PL/SQL library, 15-12
- Export
  - databases, 4-6
  - interactive mode, 4-6, 4-7
  - parameter mode, 4-6
  - preferred tools, 3-3
  - starting, 3-9
- Export Wizard
  - preferred tools, 3-3
- extended partition
  - defined, B-2
- EXTERNAL clause, 15-12
- external operating system user
  - creating, 10-15
- external OS user
  - creating, 10-39
- external procedures
  - building a DLL, 15-11
  - creating a PL/SQL library, 15-11
  - debugging, 15-14
  - EXTERNAL clause, 15-12
  - granting EXECUTE privileges, 15-12
  - registering with Oracle Database, 15-11
  - using EXTPROC, 15-9
  - writing, 15-10
- external roles
  - administering, 10-2, 10-38
  - creating, 10-29
  - environments in which to use, 9-4
- external users
  - administering, 10-2, 10-38
  - creating, 10-15, 10-39
  - environments in which to use, 9-4
- EXTPROC
  - example, 15-10
  - explained, 15-9
  - responsibilities, 15-9

## F

---

### features

- 4GT tuning, 1-9
- large user populations, 1-9
- Oracle PKI, 1-11

### file I/O enhancements, 1-5

### file permissions, 5-2 to 5-6

### files

- alert, 7-12
- maximum number for each database, 13-7
- maximum size possible, 13-7
- oracle.key, 2-6
- sample init.ora, 13-3
- size limitations, 1-5
- trace, 7-12

### FSEEK

- line terminators, 15-15

## H

---

### Hostname parameter, 7-3

## I

---

### ICX. *See* Inter cartridge Exchange

### ImagePath parameter, C-2

### Import

- databases, 4-13
- interactive mode, 4-13, 4-14
- parameter mode, 4-13
- preferred tools, 3-3

### Import Wizard

- preferred tools, 3-3

### initialization parameter file

- defined, 13-2
- editing, 13-3
- location, 13-2

### initialization parameter requirements

- Advanced Replication Support, 5-15

### initialization parameters

- OS\_ROLES, 9-4
- path in registry, 14-4

### instances

- modifying, 4-22
- Oracle Database, 1-2

- running multiple instances, 6-13

### integration with Windows

- 4GT tuning, 1-9
- Oracle Fail Safe, 1-11
- Oracle PKI, 1-11
- Oracle Services for MTS, 1-11

### interactive mode

- Export, 4-6, 4-7
- Import, 4-13, 4-14

### Inter cartridge Exchange

- accessing Web data, 15-15
- configuring, 15-16
- error messages, 15-21
- exception conditions, 15-20
- packaged functions, 15-17
- stored packages, 15-17
- using, 15-17

### internet applications

- developing, 15-5

## K

---

### Kerberos

- default use of, 9-3
- features, 9-2

### keys

- defined, 14-2

## L

---

### Load Wizard

- preferred tools, 3-3

### local database role

- creating with Oracle Administration Assistant for Windows, 10-23

### local groups

- with database privileges, 10-48

### LOCAL networking parameter, C-3

### LOG\_ARCHIVE\_DEST\_n, 4-3, 6-18, 6-20

### LOG\_ARCHIVE\_FORMAT parameter, 6-20

### LOG\_ARCHIVE\_START, 6-20

## M

---

### mapped drives, 4-3, 6-18

- MAXDATAFILES, 4-10
- memory usage, 8-6
- Microsoft Certificate Services, 12-3
- Microsoft Certificate Stores, 12-2
- Microsoft Management Console
  - defined, 3-15
  - integration with Oracle Database, 3-15
  - requirements, 10-3
  - starting, 3-11
- Microsoft ODBC Administration
  - starting, 3-7
- Migration Utility
  - preferred tools, 3-3
  - starting, 3-9
- MMC. *See* Microsoft Management Console
- monitoring
  - alert files, 7-2
  - Event Viewer, 7-2
  - Management Pack, 7-2
  - Oracle Counters for Windows Performance Monitor, 7-2
  - Oracle Database events, 3-16
  - trace files, 7-2
- multiple instances, running, 6-13
- multiple Oracle homes
  - benefits, 2-3
  - introduction, 2-2
  - overview, 2-2
  - service naming conventions, 6-2
  - use of one listener for spawning, 2-3

## N

---

- Named Pipes Protocol Adapter
  - with an Oracle Names Server, C-4
- naming conventions for multiple Oracle homes, 6-2
- NET START command, 4-12
- networking parameters
  - LOCAL, C-3
  - TNS\_ADMIN, C-3
  - USE\_SHARED\_SOCKET, C-4
- NOARCHIVELOG mode, 6-19
- NTFS
  - file system permission setting, 5-2
- NTLM
  - default use of, 9-3
  - features, 9-2
- NTS. *See* Windows native authentication

## O

---

- ObjectName parameter, C-2
- OCOPY
  - and raw files, 1-5
  - preferred tools, 3-3
- operating system authentication
  - automatically enabling during installation, 9-5
  - connecting as SYSDBA without a password, 9-5
  - OSAUTH\_PREFIX\_DOMAIN parameter, 10-40
- operating systems
  - audit trail, 3-15
  - authentication overview, 9-2
- OPERFCFGver
  - starting, 3-9
  - syntax examples, 14-20
- Optimal Flexible Architecture
  - benefits, 2-8
  - characteristics of a database, 2-9
  - default OFA database, 2-14
  - differences since previous releases, 2-10
  - introduction, 2-2
  - nondefault OFA database 1, 2-14
  - nondefault OFA database 2, 2-16
  - overview, 2-8
  - Windows and UNIX differences, 2-18
- ORA\_DBA local group
  - adding users to, 9-5
- ORA-00256 error, 4-3
- Oracle Administration Assistant for Windows
  - adding a computer to the navigation tree, 10-4
  - connecting to a database, 10-9
  - creating a local database role, 10-23
  - creating an external operating system user, 10-15
  - creating an external role, 10-29
  - database connection issues, 10-11
  - defined, 3-16
  - granting administrator privileges, 10-34
  - granting operator privileges, 10-36

- integration with Oracle Database, 3-16
  - managing remote computers, 10-3
  - saving a navigation tree configuration, 10-4
  - setting OS\_AUTHENT\_PREFIX, 10-14
  - starting, 3-7
  - using, 10-2, 14-14, 14-21
  - using the Oracle Counters for Windows Performance Monitor snap-in, 14-21
  - using the Oracle Home Configuration snap-in, 14-14
  - viewing authentication settings, 10-14
- Oracle Counters for Windows Performance Monitor
  - accessing, 7-4
  - for monitoring a database, 7-2
  - Hostname parameter, 7-3
  - integration with Windows, F-3
  - parameters, 14-8
  - Password parameter, 7-3
  - registry information, 7-3
  - starting, 3-8, 3-11, E-3
  - troubleshooting information, 7-8
  - Username parameter, 7-3
  - using, 3-16, 7-2, 14-21
- Oracle Database
  - connecting to, 6-8
  - password encryption, 6-18
  - shutting down, 6-8, 6-9
  - specifications, 13-7
  - starting, 6-8
- Oracle Database services
  - auto-starting, 6-5
  - naming conventions for multiple Oracle homes, 6-2
  - shutting down a database, 6-9
  - starting, 6-2
  - stopping, 6-4
- Oracle Database Upgrade Assistant
  - preferred tools, 3-3
  - starting, 3-7
- Oracle Directory Manager
  - starting, 3-8
- Oracle Enterprise Manager
  - Management Pack, 7-2
- Oracle Enterprise Manager Configuration Assistant
  - starting, 3-7
- Oracle Enterprise Manager Console
  - preferred tools, 3-3
  - starting, 3-7, 3-9
- Oracle home
  - new-style, defined, 2-7
- Oracle Home Configuration snap-in
  - using, 14-14
- Oracle INTYPE File Assistant
  - starting, 3-7
- Oracle Locale Builder
  - starting, 3-7
- Oracle Managed Files, 4-11
- Oracle Migration Workbench
  - starting, 3-8
- Oracle Names
  - Named Pipes Protocol Adapter, C-4
- Oracle Net
  - configuring for external procedures, 15-9
- Oracle Net Configuration Assistant
  - starting, 3-8
- Oracle Net Manager
  - starting, 3-8
- Oracle public key infrastructure, 12-2
- Oracle Real Application Clusters
  - registry values, 14-10
- Oracle Spatial
  - configuring, 5-13
- Oracle Text
  - configuring, 5-10
- Oracle Universal Installer
  - changing PATH value, 2-4
- Oracle Wallet Manager, 11-3
  - starting, 3-8
- Oracle Wallets, 11-2
  - storing in the registry, 11-2
  - storing private keys and trust points, 11-2
- ORACLE\_BASE
  - explained, 2-11
- ORACLE\_HOME
  - directory structure, 2-12
  - environment variable, 2-6, 2-7
  - specifying, 2-13
- ORACLE\_SID, 4-14, 6-13
- OracleHOME\_NAMEClientCache, C-2
- OracleHOME\_NAMECMAAdmin, C-2

- OracleHOME\_NAMECMan, C-2
- OracleHOME\_NAMETNSListener, C-2
- OracleHOME\_NAMETNSListener service, C-4
- oracle.key file, 2-6
- ORADATA directory, explained, 2-12
- ORADIM
  - command syntax errors, D-17
  - modifying an instance, 4-22
  - moving or copying password files, 6-16
  - preferred tools, 3-3
  - starting, 3-10
- ORAPWD
  - creating password files, 6-14
  - starting, 3-10
- OS\_AUTHENT\_PREFIX parameter
  - case insensitivity, 10-39
  - defined, 10-14
  - using, 10-39
- OS\_ROLES parameter
  - defined, 10-14
  - using with external roles, 9-4
- OSAUTH\_PREFIX\_DOMAIN, 10-40
- OSAUTH\_PREFIX\_DOMAIN parameter, 10-3, 10-40

## P

---

- packaged functions
  - Intercartridge Exchange, 15-17
  - UTL\_HTTP.REQUEST, 15-19
  - UTL\_HTTP.REQUEST\_PIECES, 15-19
- parameter mode
  - Export, 4-6
  - Import, 4-13
- parameters
  - AUDIT\_FILE\_DEST, 7-12
  - BACKGROUND\_DUMP\_DEST, 7-12
  - DisplayName, 14-10, C-2
  - Hostname, 7-3, 14-9
  - ImagePath, 14-10, C-2
  - INST\_LOC, 14-8
  - LOCAL, C-3
  - LOG\_ARCHIVE\_DEST\_n, 4-3, 6-18, 6-20
  - LOG\_ARCHIVE\_FORMAT, 6-20
  - LOG\_ARCHIVE\_START, 6-20

- LOGFILE, 14-10
- MSHELP\_TOOLS, 14-3
- NLS\_LANG, 14-4
- ObjectName, 14-10, C-2
- OO4O, 14-8
- ORA\_AFFINITY, 14-5
- ORA\_CWD, 14-4
- ORA\_SID\_AUTOSTART, 14-4
- ORA\_SID\_PFILE, 14-4
- ORA\_SID\_SHUTDOWN, 14-4
- ORA\_SID\_SHUTDOWN\_TIMEOUT, 14-4
- ORA\_SID\_SHUTDOWN\_TYPE, 14-4
- Oracle Counters for Windows Performance Monitor, 14-19
- ORACLE\_BASE, 14-6
- ORACLE\_GROUP\_NAME, 14-6
- ORACLE\_HOME, 14-6
- ORACLE\_HOME\_KEY, 14-6
- ORACLE\_HOME\_NAME, 14-6
- ORACLE\_PRIORITY, 14-6
- ORACLE\_SID, 4-14, 6-13, 14-7
- OS\_AUTHENT\_PREFIX, 10-14
- OS\_ROLES, 10-14
- OSAUTH\_PREFIX\_DOMAIN, 10-3, 10-40, 14-7
- OSAUTH\_X509\_NAME, 14-7
- Password, 7-3
- PERF\_FILE\_NAME, 14-10
- RDBMS\_ARCHIVE, 14-7
- RDBMS\_CONTROL, 14-7
- REMOTE\_LOGIN\_PASSWORDFILE, 6-14
- SQLPATH, 14-8
- TNS\_ADMIN, 2-7, C-3
- USE\_SHARED\_SOCKET, C-4
- Username, 7-3, 14-9
- partition
  - raw, 2-18
- partitions
  - extended, B-2
  - logical partition, B-3
  - physical disk, B-2
  - raw, B-2
- password
  - encryption, 6-18
  - utility, 6-14
- password file

- authenticating database administrators, 6-14
- creating, 6-14
- hiding, 6-14
- viewing, 6-16
- Password parameter, 7-3, 14-9
- passwords
  - not needed with SYSDBA, 9-5
- PATH, changing the value of, 2-3
- PERFORMANCE key, 14-8
- Performance Monitor
  - See* Oracle Counters for Windows Performance Monitor
- Performance Pack, monitoring a database, 7-2
- performance, increasing, 2-17
- PhysicalDrive, B-2
- PL/SQL Embedded Gateway, 15-2
- postinstallation
  - setting NTFS file system permissions, 5-2
  - setting Windows registry security, 5-5
- PRAGMA RESTRICT\_REFERENCES, with
  - Intercartridge Exchange, 15-20
- privileges
  - in Windows local groups, 10-48
- Pro C-C++
  - starting, 3-8
- Process Explode, 3-19
- Process Viewer, 3-18
- PWDSID.ORA file, 6-14

## Q

---

- QuickSlice, 3-18

## R

---

- RAID. *See* Redundant Array of Independent Disks
- raw files
  - using, 1-5
- raw partition
  - defined, B-2
  - logical partition, B-3
  - overview, B-2
  - physical disk, B-2
- raw partitions
  - defined, 2-18

- Recovery Manager
  - preferred tools, 3-3
  - starting, 3-10
- Recovery Wizard
  - preferred tools, 3-3
- redo log files
  - archiving, 6-19
- Redundant Array of Independent Disks, 2-17
- REGEDT32 command, 4-14
- registering an external procedure, 15-11
- registry
  - adding parameters, 14-12
  - and Oracle Real Application Clusters, 14-10
  - configuration parameters, defined, 14-2
  - DisplayName, 14-10, C-2
  - editor, 14-2
  - editor, starting, 3-11
  - Hostname, 7-3, 14-9
  - ImagePath, 14-10, C-2
  - INST\_LOC, 14-8
  - keys, defined, 14-2
  - LOGFILE, 14-10
  - modifying values, 14-11
  - MSHELP\_TOOLS, 14-3
  - NLS\_LANG, 14-4
  - ObjectName, 14-10, C-2
  - OO4O, 14-8
  - ORA\_AFFINITY, 14-5
  - ORA\_CWD, 14-4
  - ORA\_SID\_AUTOSTART, 14-4
  - ORA\_SID\_PFILE, 14-4
  - ORA\_SID\_SHUTDOWN, 14-4
  - ORA\_SID\_SHUTDOWN\_TIMEOUT, 14-4
  - ORA\_SID\_SHUTDOWNTYPE, 14-4
  - ORACLE\_BASE, 14-6
  - ORACLE\_GROUP\_NAME, 14-6
  - ORACLE\_HOME, 14-6
  - ORACLE\_HOME\_KEY, 14-6
  - ORACLE\_HOME\_NAME, 14-6
  - ORACLE\_PRIORITY, 14-6
  - ORACLE\_SID, 14-7
  - OracleHOME\_NAMEClientCache, C-2
  - OracleHOME\_NAMECMAdmin, C-2
  - OracleHOME\_NAMECMan, C-2
  - OracleHOME\_NAMETNSListener, C-2

- OSAUTH\_PREFIX\_DOMAIN, 10-40, 14-7
- OSAUTH\_X509\_NAME, 14-7
- Password, 7-3, 14-9
- PERF\_FILE\_NAME, 14-10
- PERFORMANCE key, 14-8
- RDBMS\_ARCHIVE, 14-7
- RDBMS\_CONTROL, 14-7
- REG\_DWORD, 14-2, 14-13
- REG\_EXPAND\_SZ, 14-2, 14-13
- REG\_MULTI\_SZ, 14-2, 14-13
- REG\_SZ, 14-2, 14-13
- REGEDT32, 14-11, 14-12
- setting security, 5-5
- SQLPATH, 14-8
- update ORACLE\_SID, 4-14
- Username, 7-3, 14-9
- using OPERFCFGver, 14-20
- reliability, increasing, 2-17
- remote computers
  - managing with Oracle Administration Assistant for Windows, 10-3
- remote computers, accessing database files, 6-18
- REMOTE\_LOGIN\_PASSWORDFILE, 6-14
- role authorization
  - description, 9-3
  - method enhancements, 9-3
- roles
  - creating, 10-29
  - creating a local database role with Oracle Administration Assistant for Windows, 10-23
  - when to use enterprise roles, 9-4
  - when to use external roles, 9-4

## S

---

- Server Manager
  - replacement, 3-2
- services, 6-2
  - auto-starting, 6-5
  - shutting down a database, 6-9
  - starting, 4-10, 6-2
  - stopping, 6-4
- SET INSTANCE command, 10-46, 10-48
- SET ORACLE\_SID=SID, 6-13
- Shared server process, 1-9
- shutting down
  - databases, 6-8, 6-9
- snap-ins
  - Oracle Counters for Windows Performance Monitor, 14-21
  - Oracle Home Configuration, 14-14
- specifying an archiving file format, 6-20
- SQL\*Loader
  - control file conventions, 3-14
  - direct path option, 3-13
  - preferred tools, 3-3
  - starting, 3-10
- SQL\*Plus
  - preferred tools, 3-3
  - shutting down the database, 6-8
  - starting, 3-8, 3-10, 6-8
  - starting the database, 6-8
- SQL\*Plus Worksheet
  - preferred tools, 3-3
  - starting, 3-8
- sqlnet.ora file
  - and Windows native authentication, 10-46, 10-47
  - location of, 10-46, 10-47
- starter database
  - archiving mode, 6-19
- starting
  - databases, 6-8
  - Oracle Counters for Windows Performance Monitor, 7-4
  - Oracle Database services, 6-2
  - SQL\*Plus, 6-8
- stopping, Oracle Database services, 6-4
- stored packages, Intercartridge Exchange, 15-17
- storing private keys and trust points
  - Oracle Wallets, 11-2
- striping disks, 2-18
- symbolic links, 2-19
  - creating, B-5
- SYSDBA privileges
  - connecting without a password, 9-5
  - for a single database on a computer, 10-34
  - for all databases on a computer, 10-5
- SYSOPER privileges

for a single database on a computer, 10-36  
for all databases on a computer, 10-7

## T

---

### tablespaces

Advanced Replication support, 5-14, 5-16

Task List, 3-19

### Task Manager

starting, 3-11

using, 3-17

### threads

and Microsoft Management Console, 3-15

and multiple Oracle Database instances, 1-2

and ORASTACK, 1-4

and shared server process, 1-9

and UNIX processes, F-6

defined, 1-2

optional and required, 1-2

process errors, D-4

processor affinity, 14-5

scheduling priority, 14-6

### TKPROF

starting, 3-10

TNS\_ADMIN networking parameter, C-3

### tools, starting

Data Pump Export, 3-9

Data Pump Import, 3-9

Database Configuration Assistant, 3-7

DBVERIFY, 3-9

Event Viewer, 3-11

Export, 3-9

Microsoft Management Console, 3-11

Microsoft ODBC Administration, 3-7

Migration Utility, 3-9

OPEFCFGver, 3-9

Oracle Administration Assistant for  
Windows, 3-7

Oracle Counters for Windows Performance  
Monitor, 3-8, 3-11

Oracle Database Upgrade Assistant, 3-7

Oracle Directory Manager, 3-8

Oracle Enterprise Manager Configuration  
Assistant, 3-7

Oracle Enterprise Manager Console, 3-7, 3-9

Oracle INTYPE File Assistant, 3-7

Oracle Locale Builder, 3-7

Oracle Migration Workbench, 3-8

Oracle Net Configuration Assistant, 3-8

Oracle Net Manager, 3-8

Oracle Wallet Manager, 3-8

ORADIM, 3-10

ORAPWD, 3-10

Pro C-C++, 3-8

Recovery Manager, 3-10

Registry Editor, 3-11

SQL\*Loader, 3-10

SQL\*Plus, 3-8, 3-10

SQL\*Plus Worksheet, 3-8

Task Manager, 3-11

TKPROF, 3-10

User Manager, 3-11

### trace files

for monitoring a database, 7-2

using, 7-12

### troubleshooting

ORA-12560 error, D-27

ORA-28575 error, D-27

TNS-12203 error, D-27

tuning Windows Server operating system, 8-2

## U

---

UNC, 4-2, 6-18

Universal Naming Convention, 4-2, 6-18

### UNIX

and Optimal Flexible Architecture, 2-18

and Windows, Oracle Database differences, F-1

USE\_SHARED\_SOCKET networking  
parameter, C-4

### user authentication

description, 9-3

enhancement methods, 9-3

when to use enterprise users, 9-4

when to use external users, 9-4

### User Manager

defined, 3-18

integration with Oracle Database, 3-18

starting, 3-11

Username parameter, 7-3



UTL\_FILE  
  using, 15-15  
UTL\_HTTP.REQUEST, Intercartridge  
  Exchange, 15-19  
UTL\_HTTP.REQUEST\_PIECES, Intercartridge  
  Exchange, 15-19

## V

---

viewing  
  password file, 6-16

## W

---

Wallet Resource Locator, 12-3  
Web data, Intercartridge Exchange, 15-15  
Windows  
  and UNIX, Oracle Database differences, F-1  
  diagnostic and tuning utilities, 3-18  
  extensions for internet development, 15-5  
Windows 2000 domains  
  administering external users and roles with  
    Oracle Administration Assistant for  
    Windows, 10-2  
Windows authentication protocols  
  default protocol used, 9-3  
  with Windows 2000, 9-2  
  with Windows NT 4.0, 9-2  
Windows domains  
  administering external users and roles, 10-38  
  basic features, 9-4  
Windows local groups  
  with database privileges, 9-5, 10-48  
Windows native authentication  
  benefits, 9-2  
  enhancements, 9-3  
  installation of, 9-2  
  methods and use of, 9-2  
  overview, 9-2  
  role authorization enhancements, 9-3  
  setting the sqlnet.ora file, 10-46, 10-47  
  user and role requirements, 9-3  
  user authentication enhancements, 9-3  
Windows tuning  
  applying latest service packs, 8-8

  closing unnecessary foreground  
    applications, 8-11  
  configuring server to be an application  
    server, 8-6  
  disable unnecessary services, 8-6  
  foreground applications, 8-5  
  multiple striped volumes for sequential and  
    random access, 8-10  
  overview, 8-2  
  removing unused network protocols, 8-7  
  resetting the network protocol bind order, 8-8  
  using hardware and operating system  
    striping, 8-8

Windows-specific  
  archiving procedures, 6-20  
  audit trail availability, 7-10  
  audit trail facility, 7-10  
  automatic database startup after restart, 6-5  
  initialization parameter file, 13-2  
  parameter file location, 13-2  
  parameter filename and location, 13-2  
  password filename and location, 6-14  
  role syntax, 10-48  
  trace file names, 7-12

